



ISO
9001:2008
REGISTERED

MANUFACTURERS, IMPORTERS AND EXPORTERS OF SURGICAL INSTRUMENTS.

info@belmeraent.com

belmeraent@gmail.com

www.belmeraent.com



Surgical Instruments Catalogue



TABLE OF CONTENTS







	DESCRIPTION	SECTION	PAGE #	
15:	Amputation, Elevators, Raspatories, Bone Livers, Bone Files & Curettes	06	319 - 347	
16:	Mallets, Tampers, Chisels, Gauges, Bone Holding Forceps, Bone Rongeurs, Bone Cutting Forceps, Meniscus Instruments	06	348 - 379	
17:	Wire Extension, Finger Nail Instruments	06	380 - 392	
18:	Plaster Instruments	07	393 - 397	
19:	Suction Instruments	07	398 - 404	
20:	TUNGSTEN CARBIDE INSERTS	07	405 - 420	
21:	HOSPITAL WARES	07	421 - 431	

TABLE OF CONTENTS















DESCRIPTION	SECTION	PAGE #	
01: Diagnostic, Anaesthesia, Scalpels & Knives	01	1 - 22	
02: Scissors	02	23 - 51	
03: Forceps, Clamps	02	52 - 95	
04: Needle Holders	02	96 - 101	
05: Hooks & Retractors	02	102 - 114	
06: Forceps, Intestinal Clamps	03	115 - 167	
07: Biopsy Forceps,	03	168 - 193	

TABLE OF CONTENTS

	DESCRIPTION	SECTION	PAGE #	
08:	Blader Retractors, Urinary Instruments, Trocars	03	194 - 208	
09:	Vaginal Specula & Retractors	04	209 - 220	
10:	Utrine Dilators, Probes, Forceps, Myoma Instruments	04	221 - 236	
11:	Biopsy Instruments	04	237 - 245	
12:	Obstetrics	04	246 - 254	
13:	Tracheotomy, Cardiovascular & Thoracic Surgery	05	255 - 309	
14:	Bone Punches & Rongeurs	05	310 - 318	

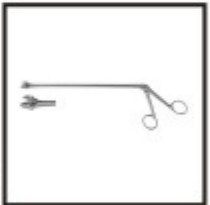
Percussion Hammers & Aesthesiometers



Stethoscopes



01-2010
PINARD
of aluminium
Size: 155 mm

½



01-2011
aus Holz
Wooden
Size: 145 mm

½



01-2012
BOWLES
Stethoscope With
Diaphragm,
In Plastic Pouch

¼



01-2013
ANESTOPHON
Ø47mm

¼



01-2014
FORD-BOWLES
Combination Stethoscope
With Diaphragm and Bell
Dual Chest Piece
With Two Outlets



¼



01-2015
BOWLES
Stethoscope With
Diaphragm,
Flat Model,
Suitable Also
For Anaesthesia
Chest Piece Only
40 mm Diam

¼

Head Mirrors & Head Bands

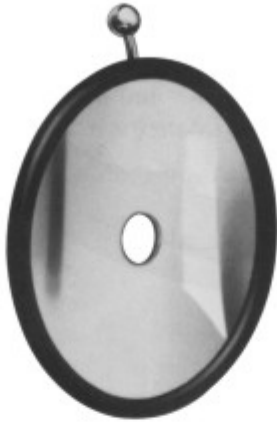

01-2016
ZIEGLER Ø 90mm
Head mirror only
with rubber coating



01-2017
ZIEGLER Ø 90mm
Head mirror only
with metal coating



01-2018
ZIEGLER
Head band of plastic, black only

01-2019
ZIEGLER
Head band of plastic, white only



01-2020
MURPHY
Head band of celluloid, white only



01-2021
Head band of plastic,
white, soft pattern



01-2022
Head mirror
with black plastic head
band

Head Lights



01-2026
spare bulb

01-2023
CLAR
Head light, 6 volt, with adjustable joint, white celluloid head band, cord with plugs for transformer

01-2024
White celluloid head band, only, for

01-2025
Spare mirror only, for

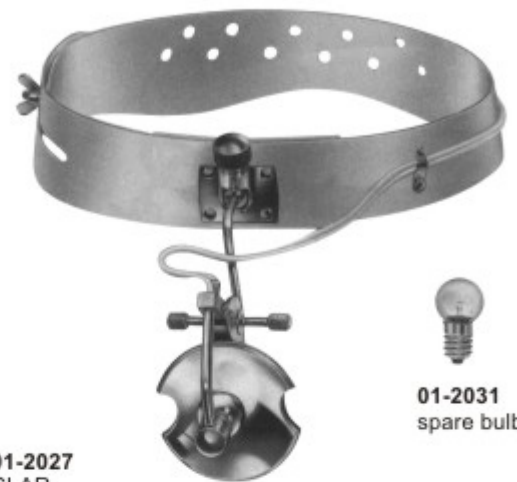

01-2027
CLAR
Head light, 6 volt, with adjustable joint, white celluloid head band, with foam rubber pad and cord with plugs for transformer

01-2028
White celluloid head band, only, for head light

01-2029
mirror only, for head light

01-2030
spare foam rubber pad, for head band



01-2033
spare bulb

01-2032
JANSEN
Head light, 6 volt, with adjustable joint, white plastic head band, cord with plugs for transformer



01-2035
spare bulb

01-2034
LANGENBECK
Head light, 3.7 volt, with adjustable joint, white plastic head band, cord with plugs for transformer



01-2036
HERBERHOLD
Pocket-Accu, 6 volts, with cord for head lights

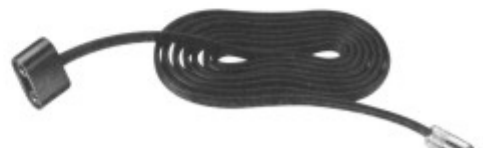

01-2037
Extension cord only, to connect the accu to the cord of the head lights



01-2038
Charging Set for pocket accu5036
mains current: 220-240 volts, 50-60 Hz



01-2039
220 volt / 220 volts
01-2040
120 volt / 120 volts
Transformer

Tongue Depressors, Retractors

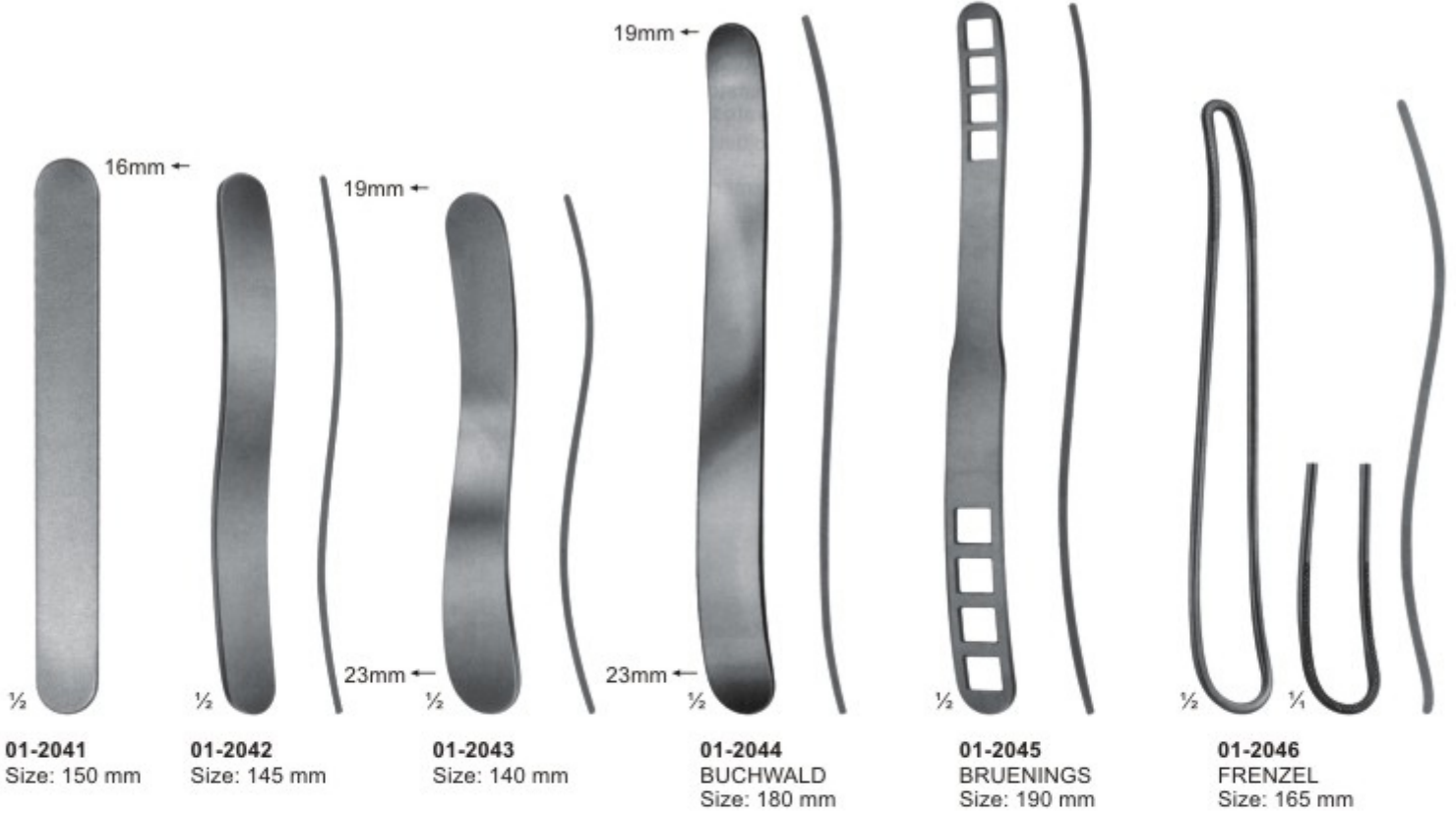

Mouth Gags And Tongue Forceps



1/2
01-2055
SCHIMMELBUSCH
Ether Mask



1/2
01-2056
HEISTER
Mouth Gag
Size: 130 mm



1/2
01-2057
FERGUSON-ACKLAND
Mouth Gag
Size: 145 mm



1/2
01-2058
DENHARDT
Mouth Gag With
Silicon Inserts,
Interchangeable
Size: 125 mm



1/2
01-2059-01-2060
ROSER KOENIG
Mouth Gag
Size: **01-2059** 160mm
01-2060 185mm



1/2
01-2061
YOUNG
Size: 165 mm



1/4
01-2062
1 Pair Of
Rubber Pads



1/2
01-2063-2064
COLLIN



1/4
01-2063
Size: 160 mm



1/4
01-2064
Size: 170 mm

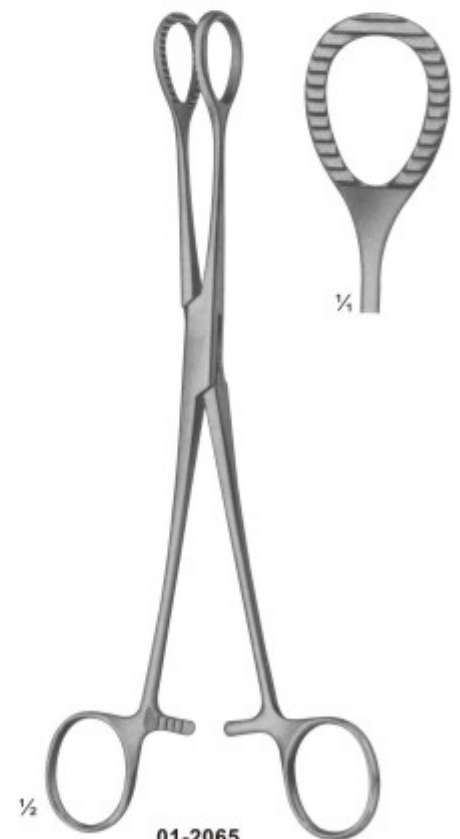

1/2
01-2065
HEYWOOD-SMITH modif.
Size: 215 mm

Blood Lancets & Laryngeal Mirrors



¼

01-2067
Ø 12 mm
Spare Mirrors Only



¼

01-2068
Ø 14 mm
Spare Mirrors Only



½

01-2066
MICHEL
Rhinoscopic Mirrors
With Interchangeable
Mirror Inserts
Size: 250 mm



½

01-2069
Mirror Handle
Size: 110 mm



½

01-2070
Mirror Handle
Size: 105 mm



½

01-2071
FRANCKE
Automatic
Blood Lancet



01-2072
KOLLE
Microscopic
Needle Holder
With Plastic
Handle
Size: 240 mm



½

01-2073
Laryngeal Mirrors With
Hexagonal Handle
Size: 180 mm



Fig. 000
Ø 6mm



Fig. 00
Ø 8mm



Fig. 0
Ø 10mm



Fig. 1
Ø 12mm

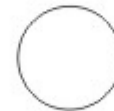

Fig. 2
Ø 14mm

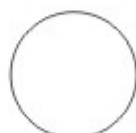

Fig. 3
Ø 16mm

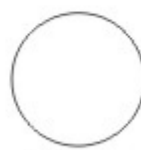

Fig. 4
Ø 18mm

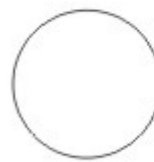

Fig. 5
Ø 20mm

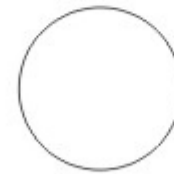

Fig. 6
Ø 22mm

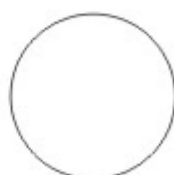

Fig. 7
Ø 24mm

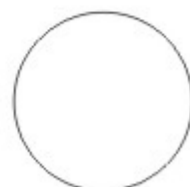

Fig. 8
Ø 26mm

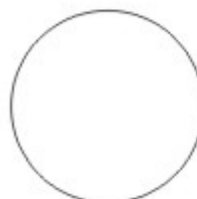

Fig. 9
Ø 28mm

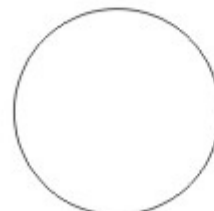

Fig. 10
Ø 30mm

Diagnostic Sets



1/2

01-2074 - 01-2076
MAGILL
Catheter Introducing
Forceps



1/4

01-2074
Infants
Size: 150 mm



1/4

01-2075
Children
Size: 200 mm



1/4

01-2076
Adults
Size: 250 mm



1/2

01-2077
Medium battery handle
only, 25 mm diam.



01-2078
Spare bulb
2.7 volt, for
Otoscopes etc.



01-2079
Spare bulb
2.6 volt, for
ophthalmoscopes



01-2080
Otoscope Set, Consists Of
Battery Handle Without Batteries,
3 Ear Specula, 1 Bulb In Velvet Lined Case



01-2081
Diagnostic Set, Otoscope With Three Specula,
Nasal Speculum, Lamp Holder, Two Laryngeal
Mirrors, Tongue Blade Holder

Laryngoscopes



1/3

01-2082
MILLER
Laryngoscope Set, Consists Of Battery Handle (Without Battery)
With Four Miller Laryngoscope Blades, Fig 1 to 4

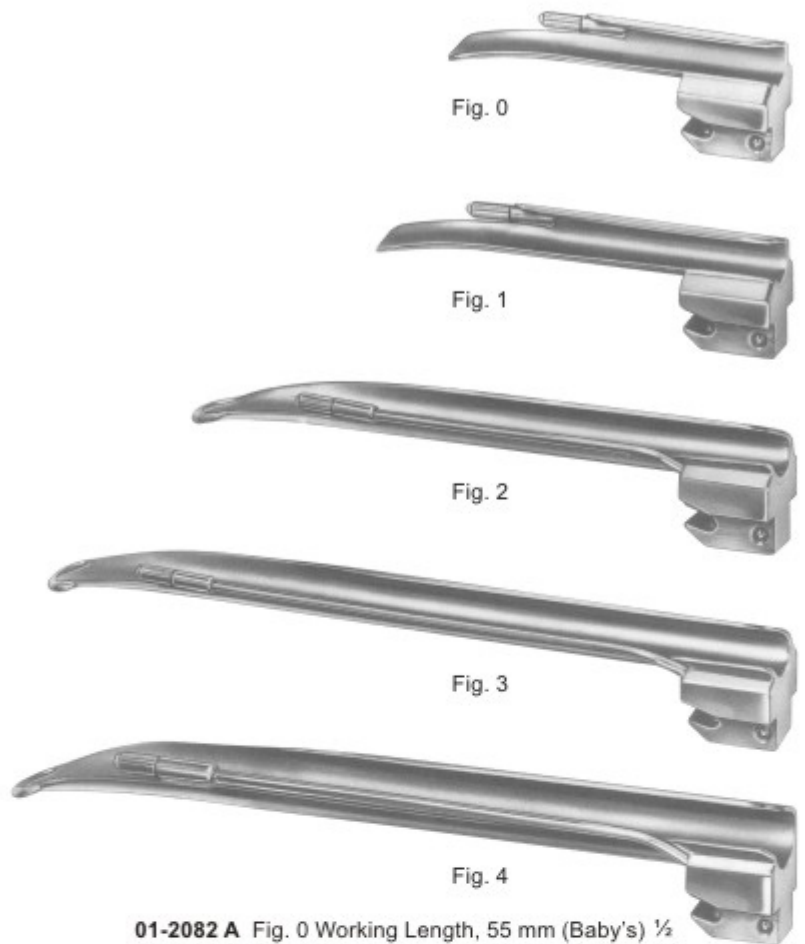

01-2082 A Fig. 0 Working Length, 55 mm (Baby's) 1/3
01-2082 B Fig. 1 Working Length, 80 mm (Children's)
01-2082 C Fig. 2 Working Length, 130 mm (Adolescent's)
01-2082 D Fig. 3 Working Length, 170 mm (Women's)
01-2082 E Fig. 4 Working Length, 180 mm (Men's)



1/3

01-2083
GUEDEL-NEGUS
Laryngoscope Set, Consists Of Battery Handle (Without Battery)
With Four Miller Laryngoscope Blades

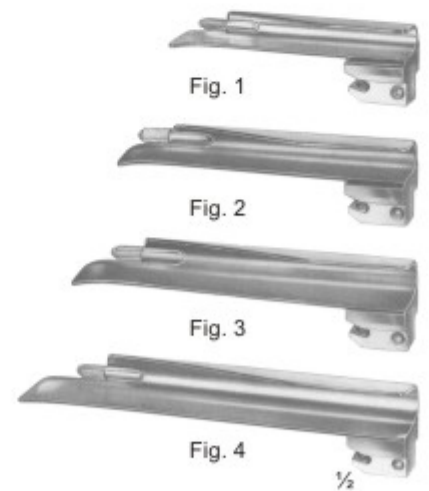

01-2083 A Fig. 1 Working Length, 70 mm (Children's)
01-2083 B Fig. 2 Working Length, 90 mm (Adolescent's)
01-2083 C Fig. 3 Working Length, 110 mm (Women's)
01-2083 D Fig. 4 Working Length, 135 mm (Men's)

Laryngoscopes



01-2084
McINTOSH
 Laryngoscope Set, Consists Of Battery Handle (Without Battery)
 With Three McIntosh Blades, Fig. 1, Fig. 2, Fig. 3

01-2085
McINTOSH
 Laryngoscope Set, Consists Of Battery Handle (Without Battery)
 With Five McIntosh Blades, Fig. 0, Fig. 1, Fig. 2, Fig. 3, Fig. 4



01-2086
FOREGGER
 Laryngoscope Set, Consists Of
 Battery Handle (Without Battery)
 With Three Foregger Blades,
 Fig. 1, Fig. 2, Fig. 3,

01-2087
FOREGGER
 Laryngoscope Set, Consists Of
 Battery Handle (Without Battery)
 With Four Foregger Blades,
 Fig. 1, Fig. 2, Fig. 3, Fig. 4,



Fig. 0



Fig. 1



Fig. 2



Fig. 3



Fig. 4

01-2085 A Fig. 0 Working Length, 55 mm (Baby's)
01-2085 B Fig. 1 Working Length, 75 mm (Children's)
01-2085 C Fig. 2 Working Length, 90 mm (Adolescent's)
01-2085 D Fig. 3 Working Length, 110 mm (Women's)
01-2085 E Fig. 4 Working Length, 135 mm (Men's)



Fig. 1



Fig. 2



Fig. 3



Fig. 4

01-2086 A Fig. 1 Working Length, 70 mm (Children's)
01-2086 B Fig. 2 Working Length, 90 mm (Adolescent's)
01-2086 C Fig. 3 Working Length, 110 mm (Women's)
01-2086 D Fig. 4 Working Length, 135 mm (Men's)



01-2088
 Fiber Optic
 Battery Handle
 30mm diam.



01-2089
 Fiber Optic
 Battery Handle
 18mm diam.



01-2090
 Replacement Lamp
 (Krypton) 2.5 V

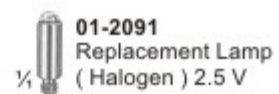

01-2091
 Replacement Lamp
 (Halogen) 2.5 V

Examination & Measuring Instruments

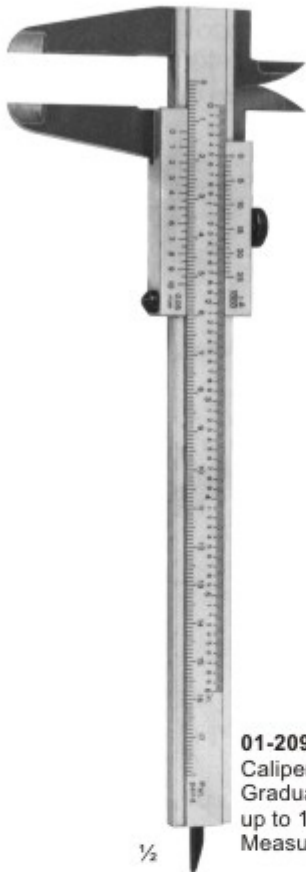

01-2092
Caliper Of Aluminium
Graduated in mm & inches
up to 180mm
Measuring Range up to 139mm



01-2093
VERNIER
Universal Caliper Of Steel
Graduated in mm & inches
up to 180mm
Measuring Range up to 120mm
with Vernier in 1/10mm & 1/16"

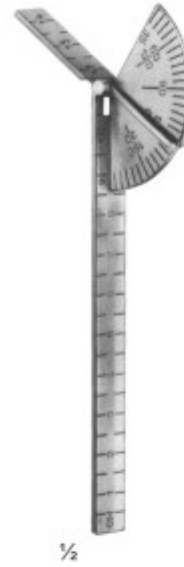

01-2094
CARROLL
Size: 145 mm
Finger Goniometer



01-2095
TOWNLEY
Graduated in
mm & inches
Size: 115 mm



01-2096
COLLIN
Druck Pressure 72 kg
Size: 125 mm



01-2097
BERTILLON
Caliper For Measuring The Head
Size: 320 mm



01-2098
CASTROVIEJO
Caliper
Size: 75mm



01-2099
MOLTGEN
Goniometer



01-2100A
Size: 150 mm

01-2100
Size: 500 mm

Dissecting Knives



01-2101 - 01-2110
Fig. 1 - 10
With Metal Handle



01-2101
Fig. 1
Size: 30mm
15cm



01-2102
Fig. 2
Size: 36mm
15cm



01-2103
Fig. 3
Size: 40mm
15.5cm



01-2104
Fig. 4
Size: 45mm
16cm



01-2105
Fig. 5
Size: 50mm
16cm



01-2106
Fig. 6
Size: 27mm
15cm



01-2107
Fig. 7
Size: 35mm
15cm



01-2108
Fig. 8
Size: 40mm
16cm



01-2109
Fig. 9
Size: 47mm
16cm



01-2110
Fig. 10
Size: 50mm
17cm

Autopsy & Cartilage Knives

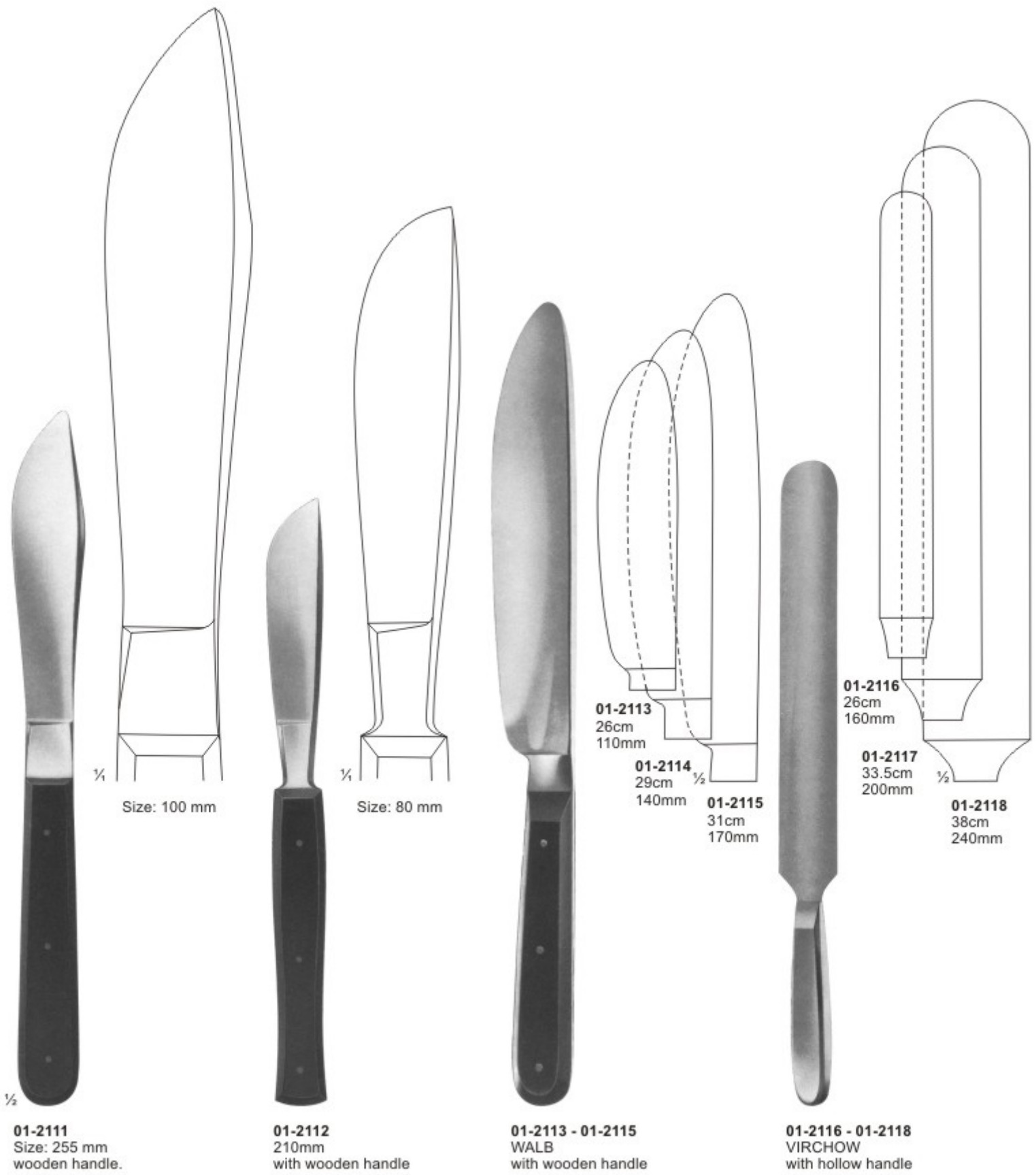

Scalpels, Tenotomes & Resection Knives

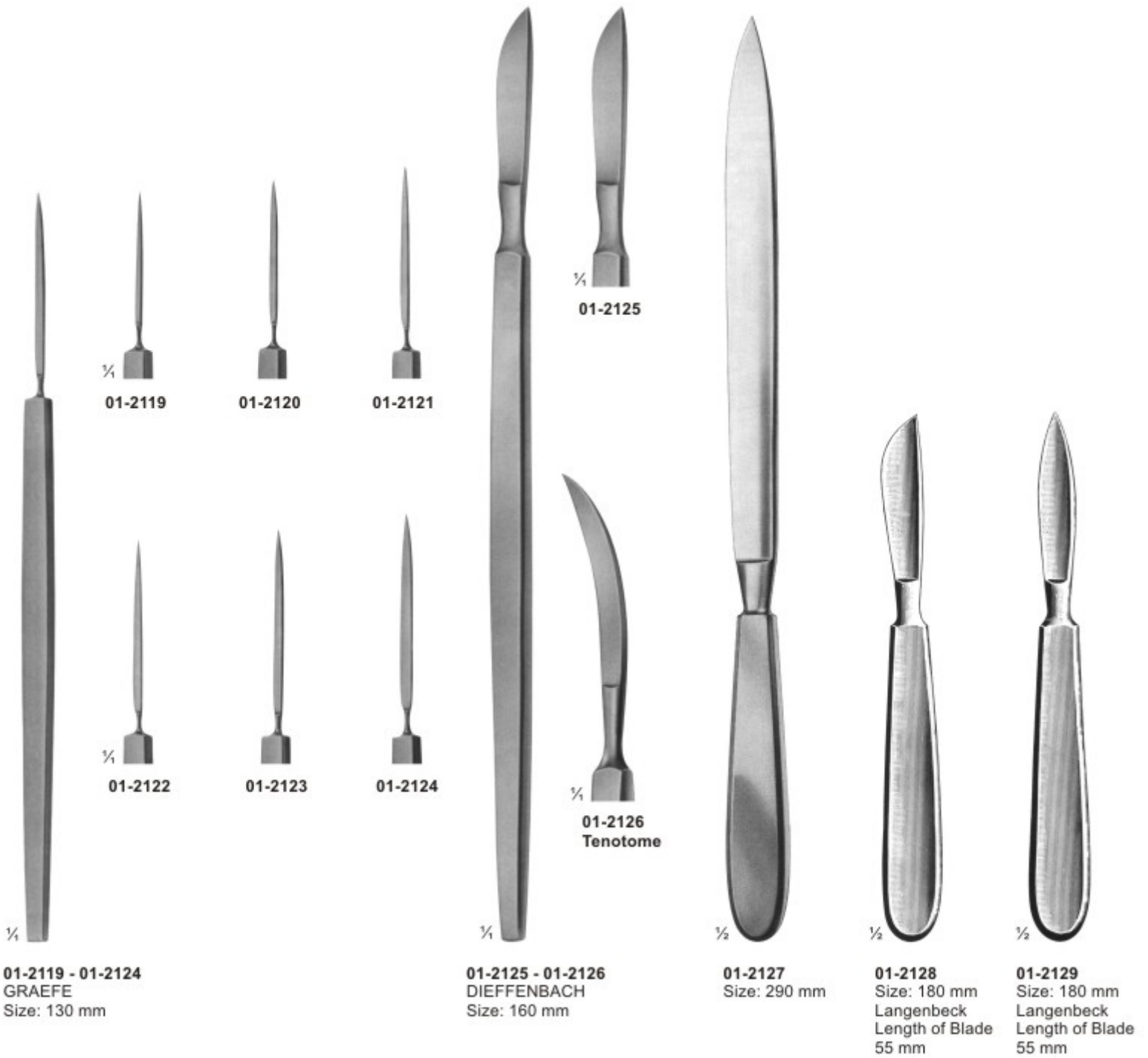

Scalpels, Tenotomes

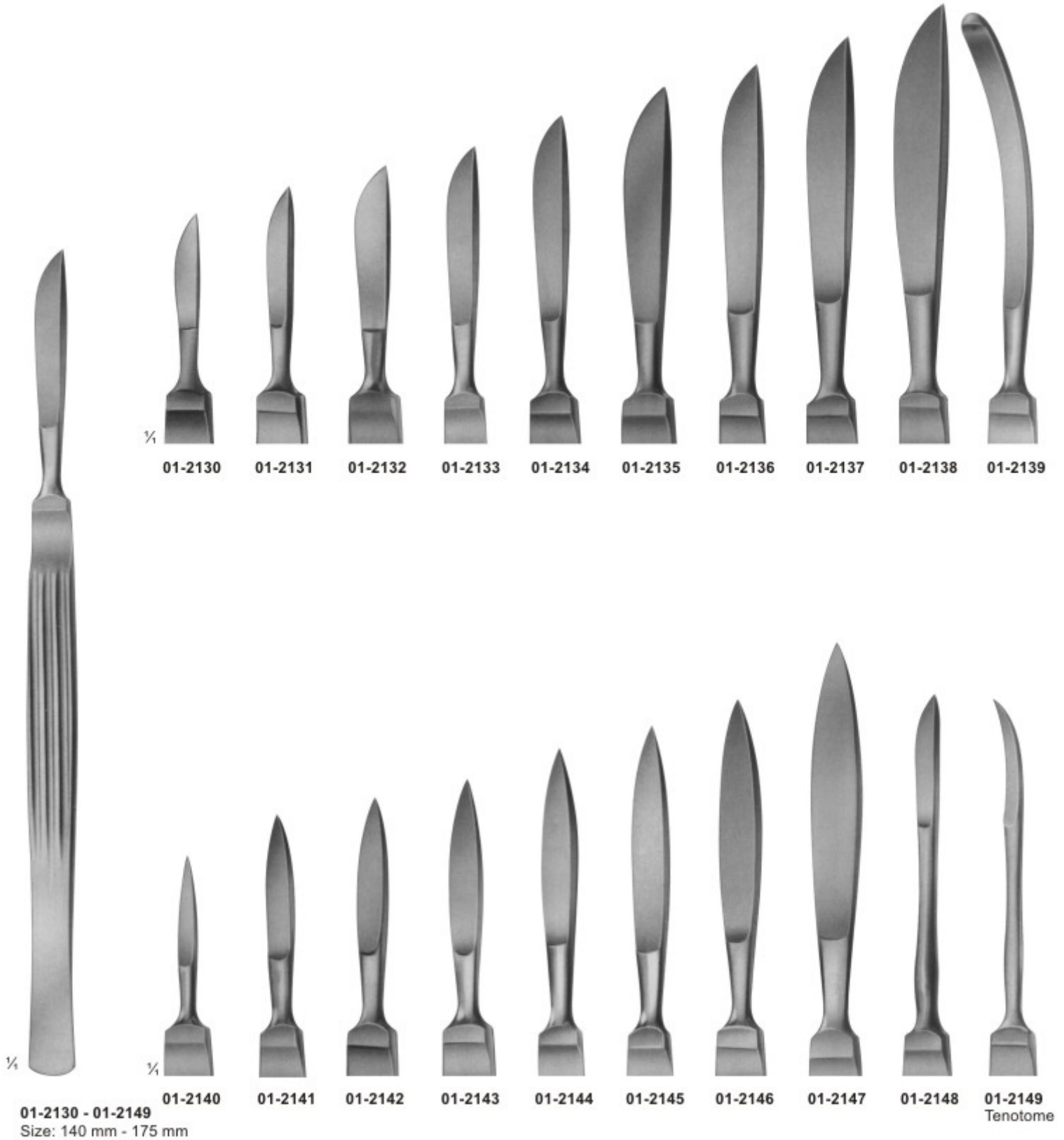

Amputating Knives, Cartilage Knives, Autopsy Knives

Double Cutting



Double Cutting

LISTON
01-2150
Size: 130 mm
01-2151
Size: 160 mm
01-2152
Size: 190 mm
01-2153
Size: 220 mm

Blade Length
Amputating Knives

01-2154
CATLIN
Size: 160 mm
Blade Length
Amputating
Knives

01-2155
LANGENBECK
Size: 120 mm
Blade Length
Flap Knives

01-2156
Size: 110 mm
Blade Length
Interosseous
Knives

01-2157
Size: 55 mm
Blade Length
With Raspatory,
Wooden Handle

01-2158
Size: 70 mm
Blade Length
Wooden Handle

01-2159
Size: 80 mm
Blade Length
Metal Handle

01-2160
Size: 195 mm
Blade Length
Metal Handle

Cone Knives, Myomatome, Trigeminal & Tonsil Knives



01-2161
AYRE
Size: 235 mm
Cone Knife

01-2162
Size: 230 mm
Cone Knife

01-2163
SEGOND
Size: 270 mm
Myomatome

01-2164
OLIVECRONA
Size: 205 mm
Trigeminal
Knife

01-2165
Size: 230 mm
Trigeminal
Knife

01-2166
FOWLER
Size: 200 mm
Tonsil Knife

01-2167
ABRAHAM
Size: 215 mm
Tonsil Knife

01-2168
BRUENINGS
Size: 215 mm
Tonsil Knife

Scalpels, Dura Knives & Comedone Extractors

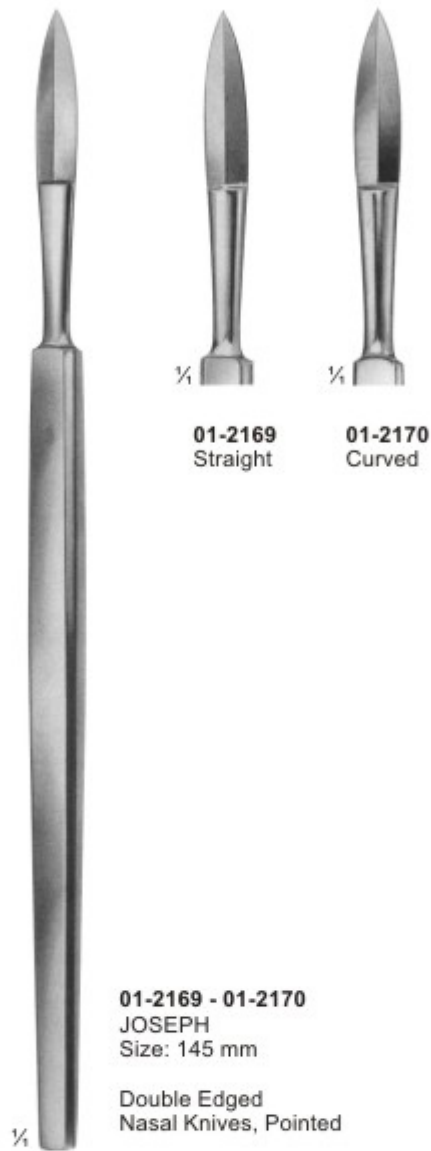

01-2169
Straight

01-2170
Curved

01-2169 - 01-2170
JOSEPH
Size: 145 mm
Double Edged
Nasal Knives, Pointed

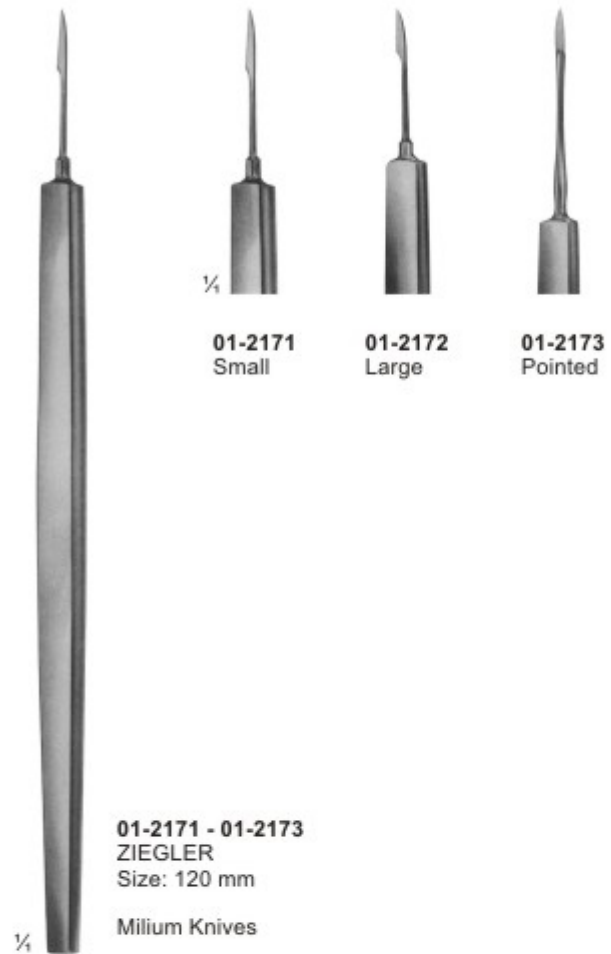

01-2171
Small

01-2172
Large

01-2173
Pointed

01-2171 - 01-2173
ZIEGLER
Size: 120 mm
Millium Knives

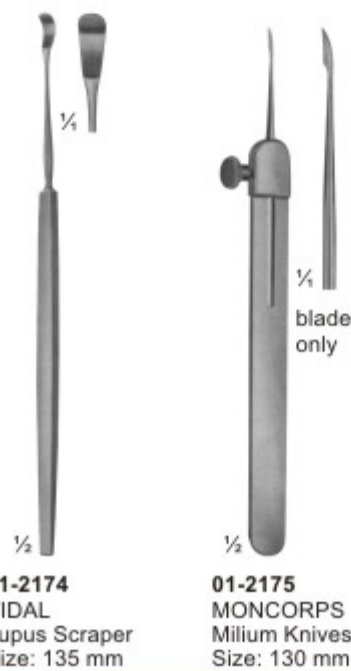

01-2174
VIDAL
Lupus Scraper
Size: 135 mm

01-2175
MONCORPS
Millium Knives
Size: 130 mm



01-2176
SAALFELD
Size: 100 mm

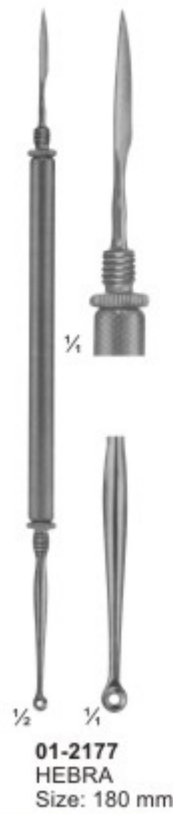

01-2177
HEBRA
Size: 180 mm

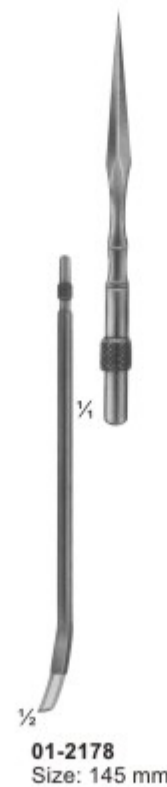

01-2178
Size: 145 mm



01-2179
UNNA
Size: 145 mm

Razor Blade Holders & Breakers



01-2180
TROUTMAN-CHRIS
Size: 90 mm
Handle Diameter 5.5 mm



01-2181
TROUTMAN-CHRIS
Size: 90 mm
Handle Diameter 5.5 mm



01-2182
Size: 110 mm



01-2183
CASTROVIEJO
Size: 130 mm
Handle Diameter 8 mm



01-2184
Size: 185 mm
Razor Blade
Breaker & Holder,
Straight

Scalpel Handles



01-2185
STANDARD
No. 4
Solid

01-2186
Double Handle
No. 4 + No. 3
Solid

01-2187
No. 4 L
Straight
Solid

01-2188
No. 4 L
Solid Angled

01-2189
COLLIN
No. 8
Hollow

01-2190
COLLIN
No. 9
Hollow

01-2191
Plastic
No.4

Scalpel Handles

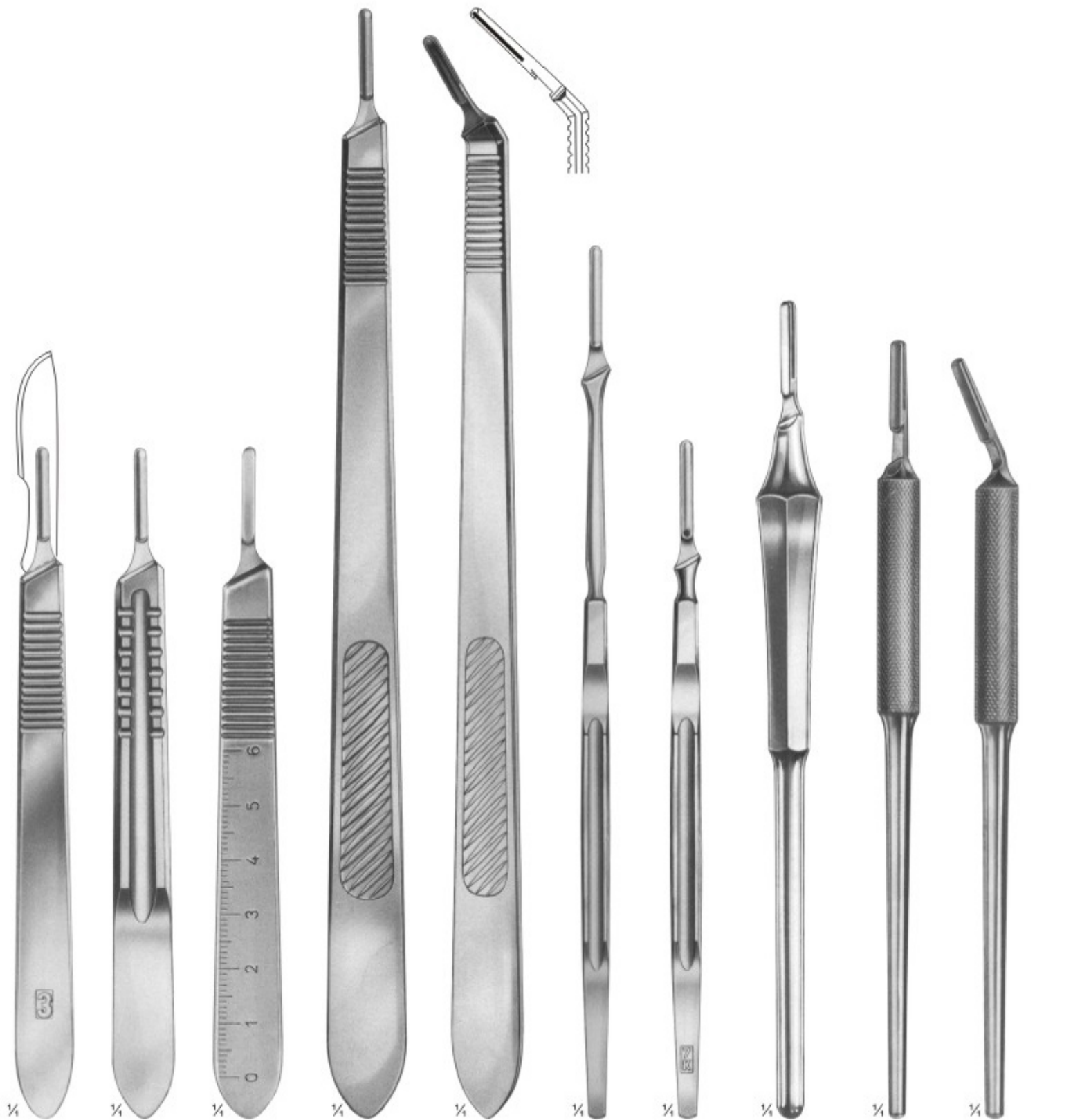

01-2192
STANDARD
No. 3
Solid
Size:12cm

01-2193
No. 3
Solid
Size:12cm
solid handle
style as
No.4

01-2194
No. 3
Solid
Size:12cm
cm-graduation

01-2195
No. 3 L
Straight
Solid, long
Size:21.5cm

01-2196
No. 3 L
Angled
Solid, long
Size:21cm

01-2197
No. 7
Solid
Size:16cm

01-2198
No. 7 K
Solid, short
Size:12.5cm

01-2199
No.3
Size:15.5cm
with round
hollow handle

01-2200
No. 3
Straight
Solid,
Round
Size:14.5cm

01-2201
No. 3
Angled
Solid, Round
Size:14cm

Razors & Dermatomes



½

01-2202
SCHINK
Size: 310 mm
Complete with 2
skin fixing plates
and 1 blade.
Adjustable from
0.1 to 2.0mm



½

01-2203
SCHINK
Spare Blade



½

01-2204
SCHINK
Skin Fixing Plate



½

01-2205
SILVER
Size: 190 mm
For Usual
Razor Blades



½

01-2206
Size: 75 mm
Cutting Length



½

01-2207
Size: 80 mm
Cutting Length

Micro Scissors, "Spring Type" Flat Handles



02-3001 - 02-3003
VANNAS
Size: 85 mm

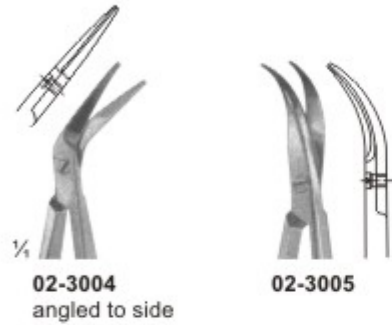

02-3004 - 02-3005
CASTROVIEJO
Size: 95 mm

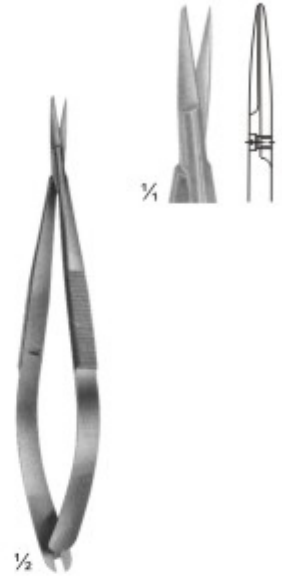

02-3006
NOYES
Size: 125 mm

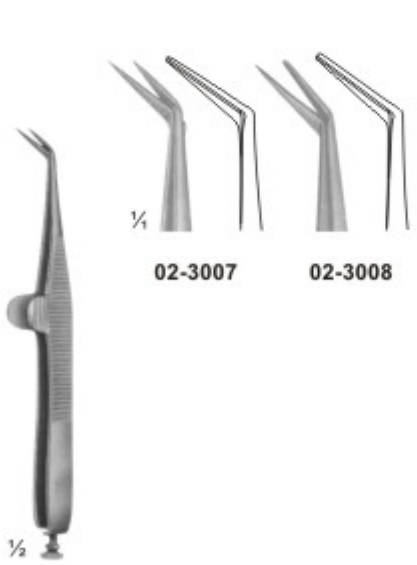

02-3007 - 02-3008
WECKER
Eye Scissor
Size: 110 mm



02-3009
CASTROVIEJO
Eye Scissor
Size: 115 mm

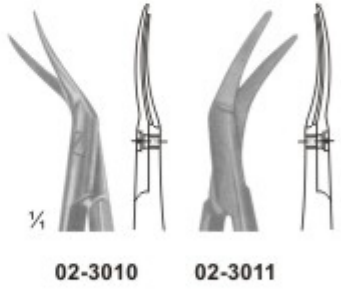
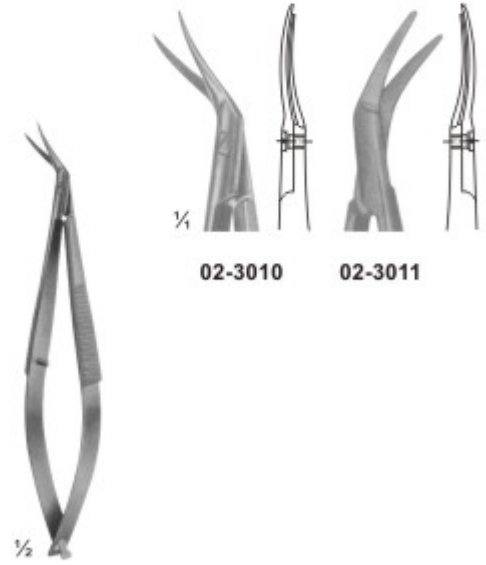

02-3010 - 02-3011
CASTROVIEJO
Eye Scissor
Size: 110 mm

Micro Scissors, "Spring Type" Flat Handles and Cross-Serration

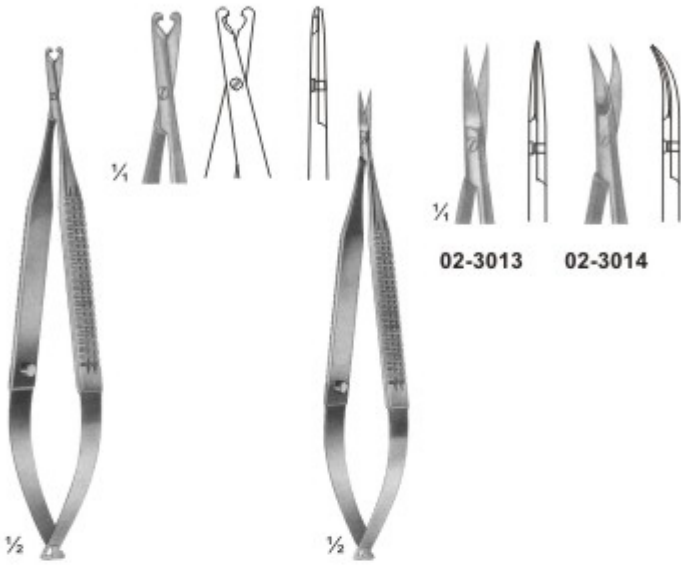

02-3012
BIEMER
Vein Scissor
Size: 130 mm

02-3013 - 02-3014
Size: 120 mm

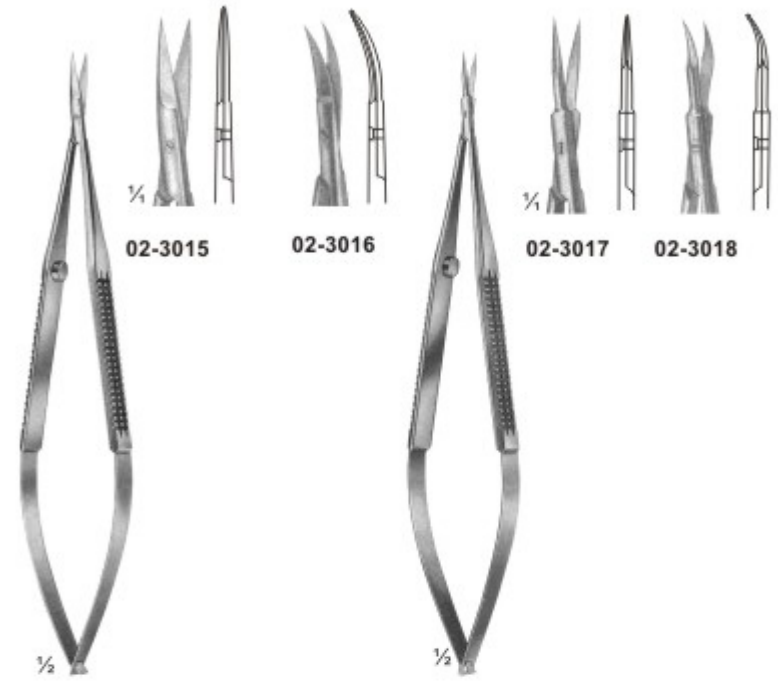

02-3015 - 02-3016
Size: 160 mm

023017 - 02-3018
VANNAS
Size: 160 mm



02-3019
CASPAR
Micro Scissor Curved

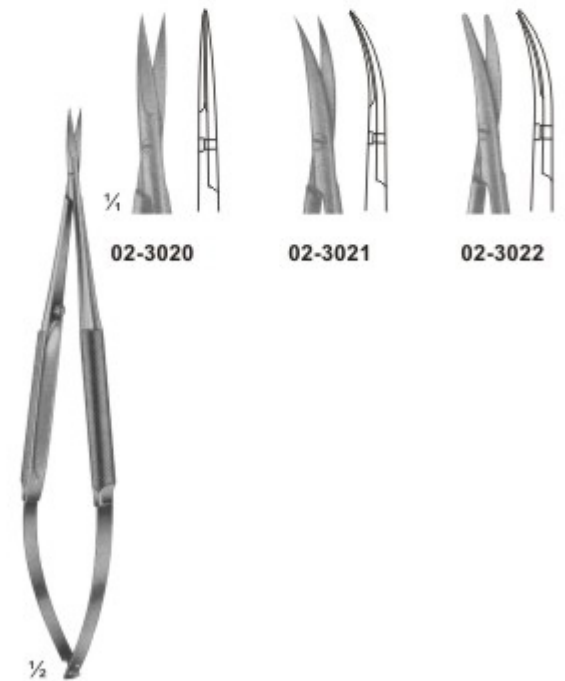

02-3020 - 02-3022
Micro Dissecting Scissor
Size: 145 mm

Micro Scissors, "Spring Type" Bayonet Shape



02-3023
YASARGIL
Size: 245 mm



02-3024
45°
Nagel



02-3025
45°



02-3026
Laterally Angled
Size: 190 mm



02-3024 - 02-3025
Laterally Angled
Size: 200 mm



02-3027

02-3028



02-3027 - 02-3028
YASARGIL
Size: 225 mm

Delicate Scissors

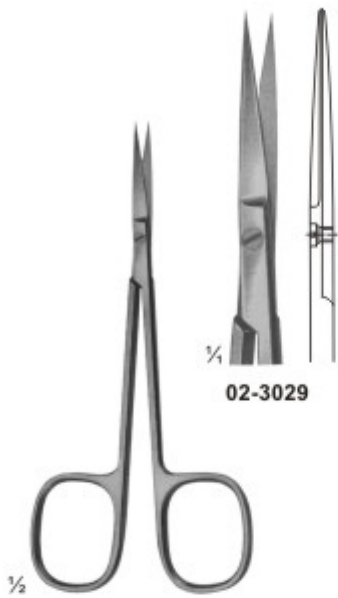

02-3029-02-3030
Size: 120 mm

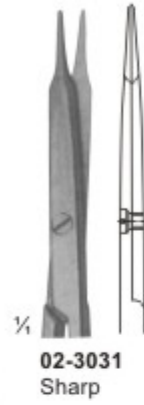

02-3031 - 02-3034
STEVENS
Dissecting Scissors
Size: 115 mm

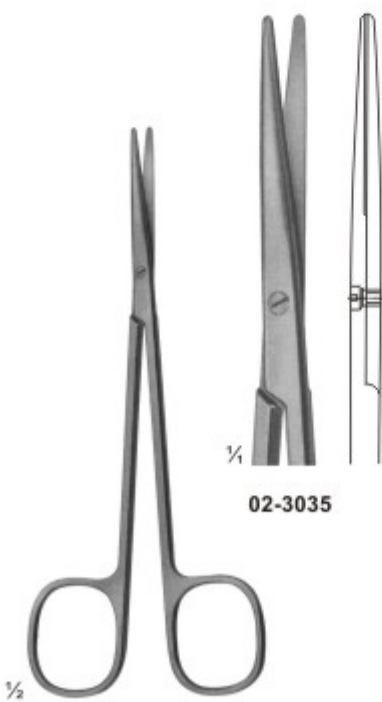

02-3035 - 02-3036
METZENBAUM
Dissecting Scissors
Size: 145 mm

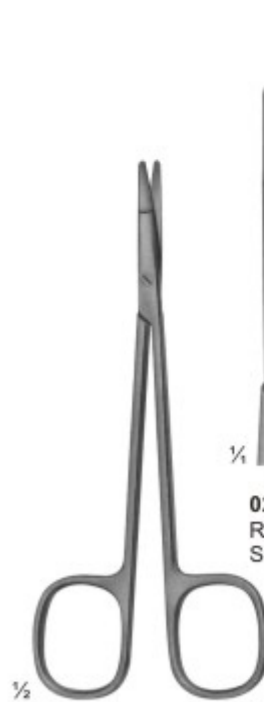

02-3037 - 02-3039
Special flat points for
dissecting and
undermining the skin

Delicate Scissors



02-3040

02-3041

02-3040 - 02-3041
Size: 90 mm



02-3042

02-3043

02-3042 - 02-3043
Size: 95 mm

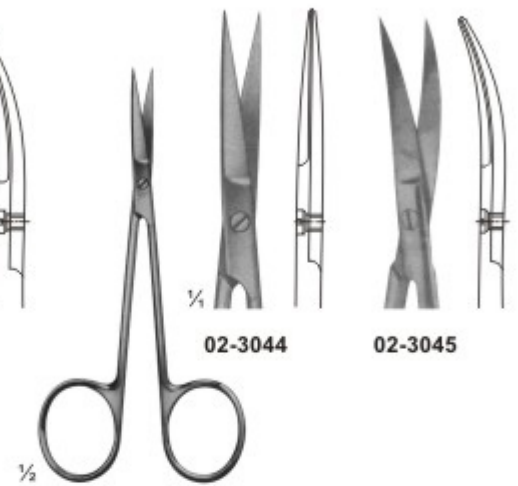

02-3044

02-3045

02-3044 - 02-3045
Size: 105 mm



02-3046

02-3047

02-3046 - 02-3047
Size: 120 mm

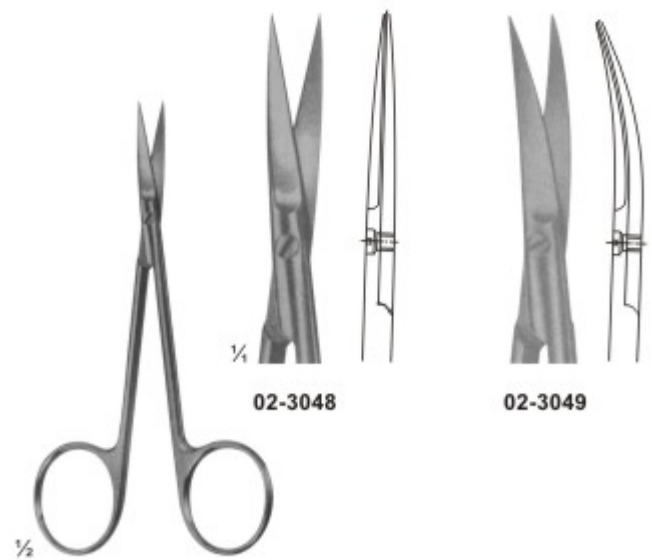

02-3048

02-3049

02-3048 - 02-3049
Size: 115 mm

Delicate Scissors



02-3050 - 02-3052
Size: 120 mm

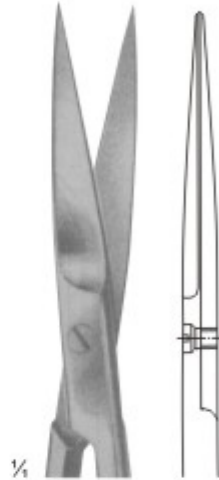

02-3050



02-3051

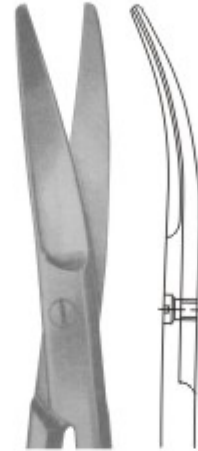

02-3052



02-3053 - 02-3056
Size: 130 mm

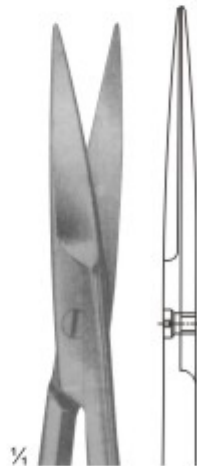

02-3053



02-3054



02-3055



02-3056

Delicate Scissors

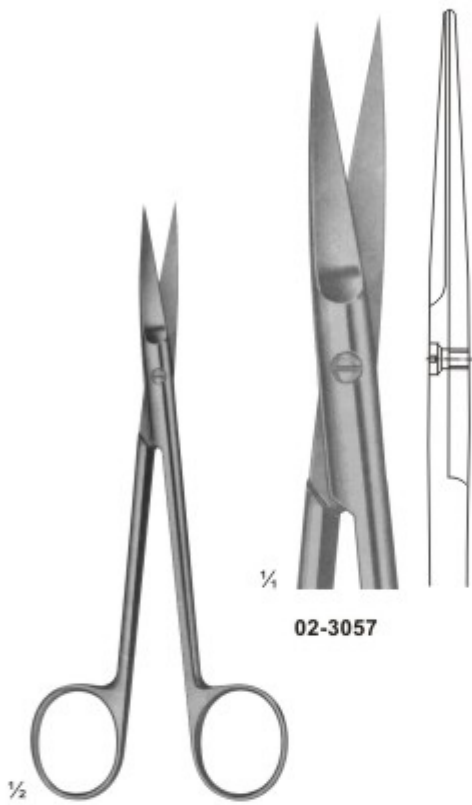

02-3057

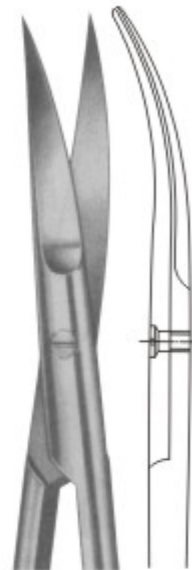

02-3058

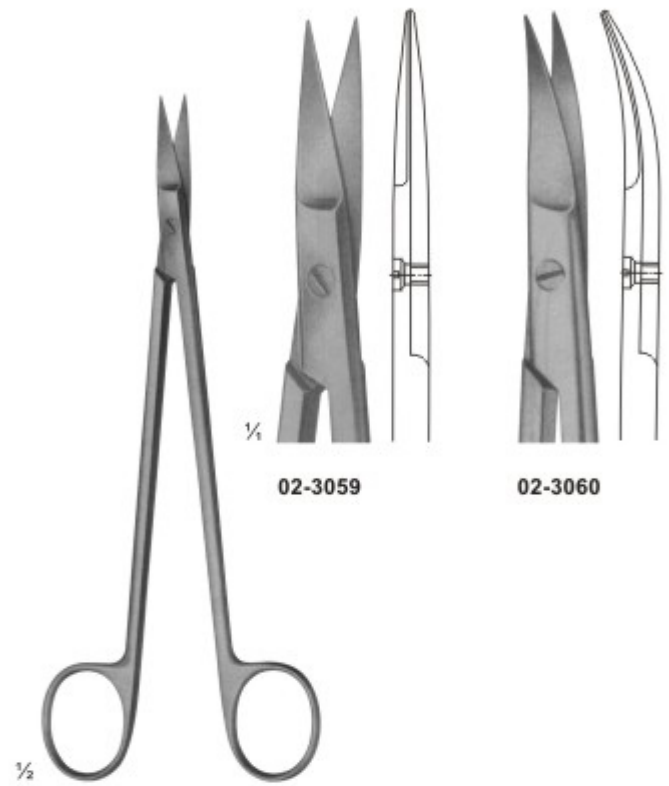

02-3059

02-3060

02-3057 - 02-3058
JOSEPH
Size: 150 mm

02-3059 - 02-3060
KELLY
Size: 175 mm



02-3061
QUINBY
Size: 130 mm

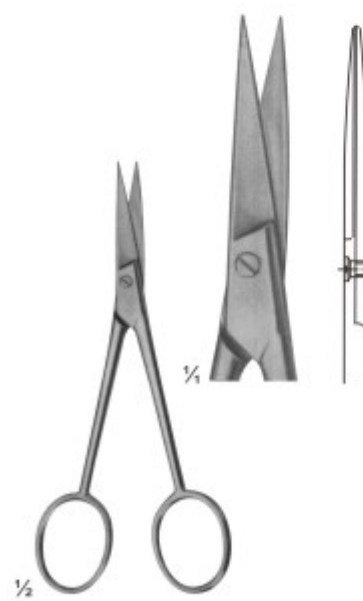

02-3062
Size: 110 mm

Surgical Scissors



02-3063 - 02-3071 (Standard Types)
02-3063 (105 mm)
02-3064 (115 mm)
02-3065 (130 mm)
02-3066 (145 mm)
02-3067 (150 mm)
02-3068 (165 mm)
02-3069 (175 mm)
02-3070 (185 mm)
02-3071 (200 mm)

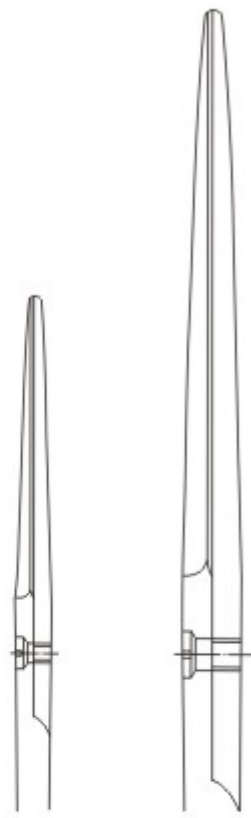

02-3063 Size: 105 mm
02-3071 Size: 200 mm

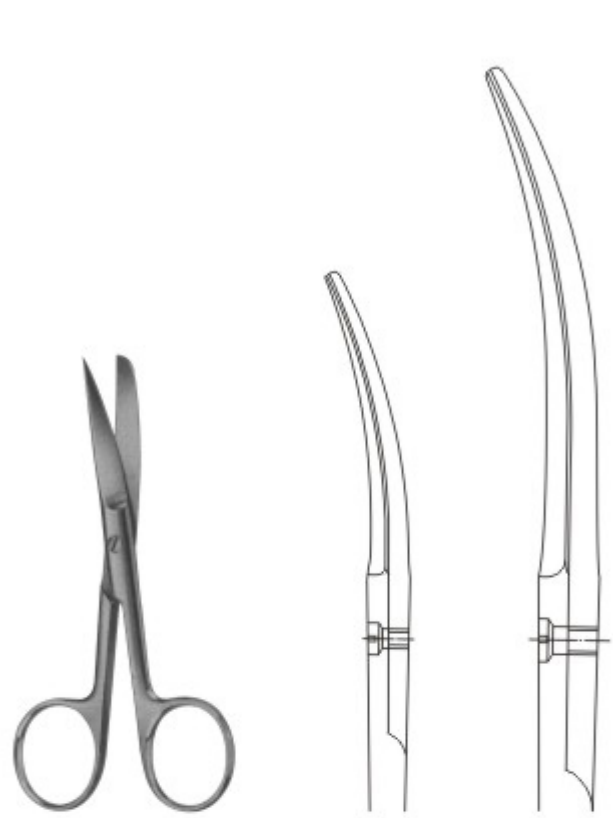

02-3072 - 02-3078 (Standard Types)
02-3072(115 mm)
02-3073 (130 mm)
02-3074 (145 mm)
02-3075 (150 mm)
02-3076 (165 mm)
02-3077 (175 mm)
02-3078(185 mm)
02-3072 Size: 115 mm
02-3078 Size: 185 mm



02-3079 - 02-3082
 Slender Types

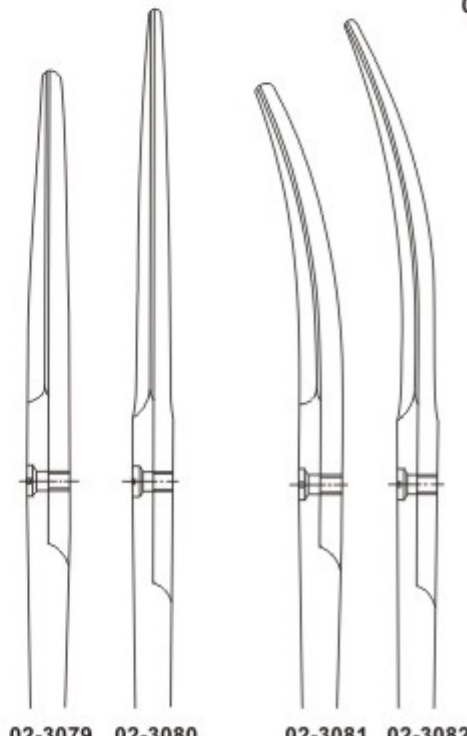

02-3079 130 mm
02-3080 145 mm
02-3081 130 mm
02-3082 145 mm



02-3083 - 02-3084
 For Wound Edges
 1 Blade Serrated

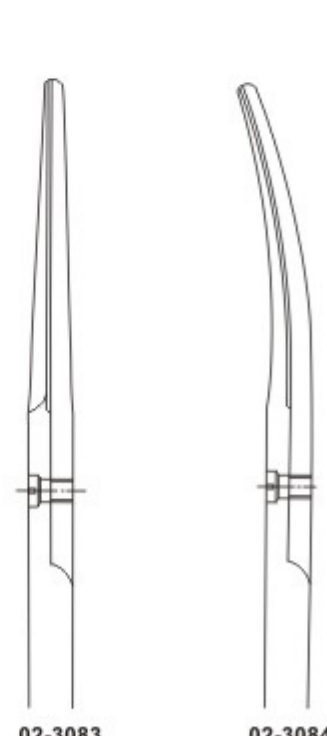

02-3083 130 mm
02-3084 130 mm

Surgical Scissors



02-3085 - 02-3089 (Standard Types) **Size: 130 mm** **02-3089** **Size: 175 mm**
02-3085 (130 mm)
02-3086 (145 mm)
02-3087 (150 mm)
02-3088 (165 mm)
02-3089(175 mm)

02-3090 - 02-3095 - COOPER **Size: 115 mm** **02-3095** **Size: 175 mm**
 Standard Types
02-3090 (115 mm)
02-3091 (130 mm)
02-3092 (145 mm)
02-3093 (150 mm)
02-3094 (165 mm)
02-3095 (175 mm)

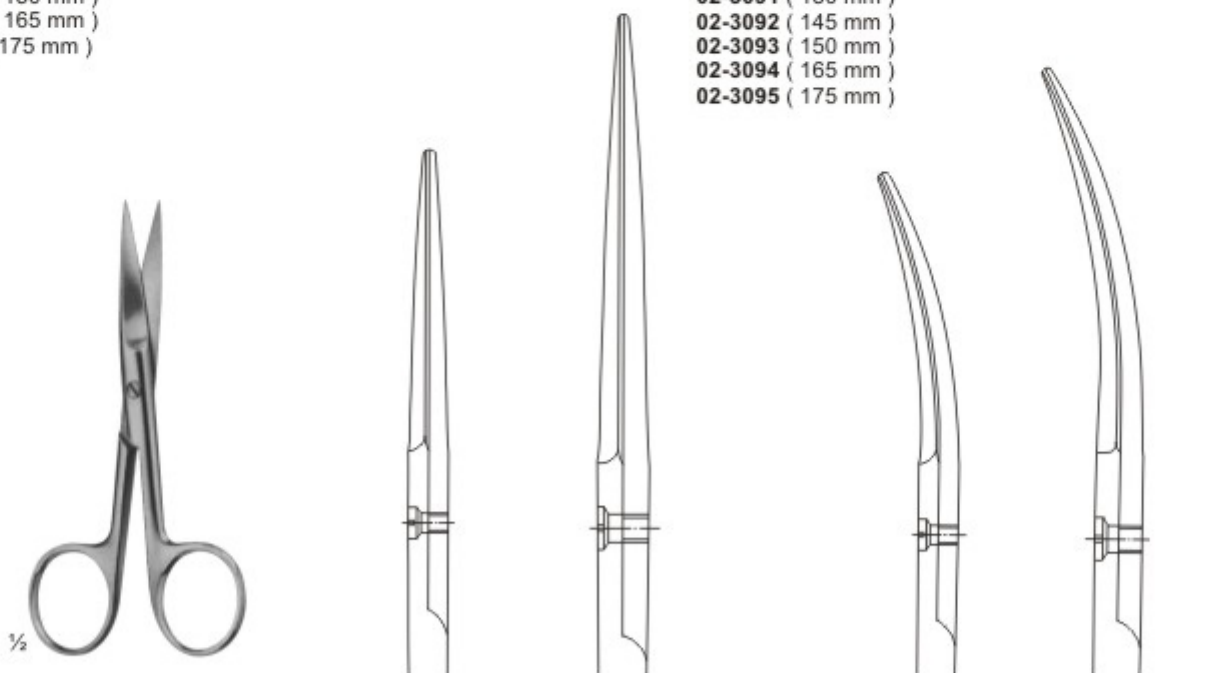

02-3096 - 02-3102A
 Standard Types
02-3096 (115 mm) **02-3100A** (115 mm)
02-3097 (130 mm) **02-3101** (130 mm)
02-3098 (145 mm) **02-3101A** (145 mm)
02-3099 (150 mm) **02-3102** (150 mm)
02-3100 (165 mm) **02-3102A** (165 mm)

02-3096 **02-3100** **02-3100A** **02-3102A**
Size: 115 mm **Size: 165 mm** **Size: 115 mm** **Size: 165 mm**

Surgical Scissors

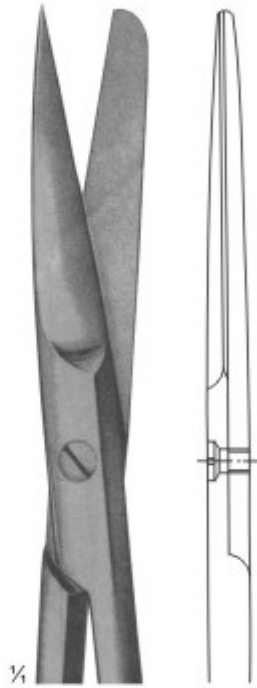

02-3103
Size: 145 mm

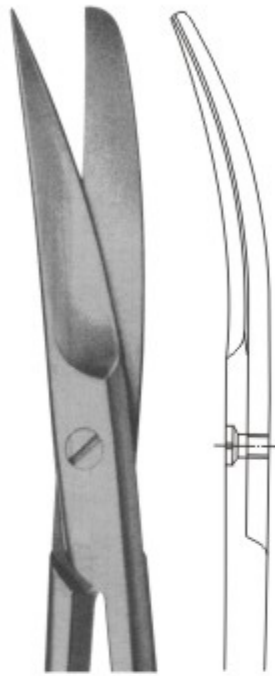

02-3104
Size: 145 mm

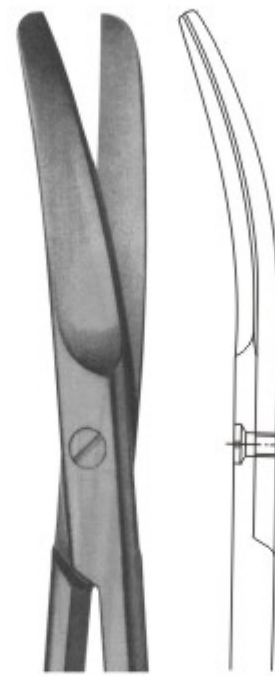

02-3105
Size: 145 mm



02-3106
Size: 145 mm

02-3103 - 02-3106
DEAVER
With flat lock



02-3107
Size: 130 mm



02-3108
Size: 145 mm



02-3109
Size: 165 mm

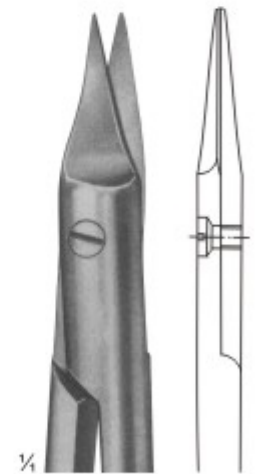

02-3110
Size: 130 mm

02-3107 - 02-3109
Incision Scissors

02-3110
SYSTRUNK
Nail Splitting Scissors

Dissecting Scissors

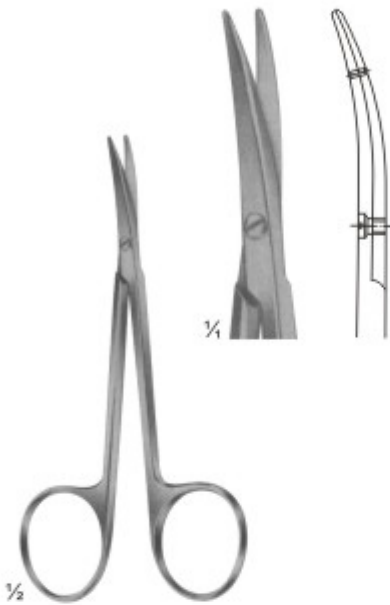

02-3111
LITTLER
Dissecting Scissors
Tips with eye for suture
Size: 115 mm

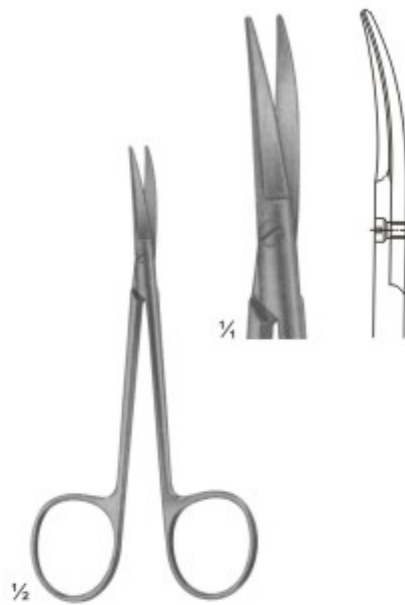

02-3112
COTTLE
Bulldog Scissors
Size: 115 mm



02-3113 - 02-3114
STEVENS
Vessel and tendon Scissors
Size: 100 mm

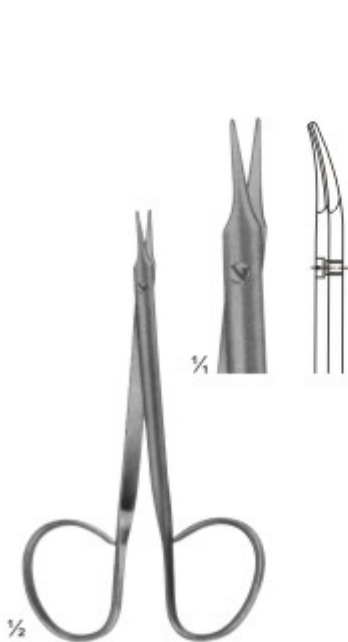

02-3115
STEVENS
Fine Dissecting Scissors
Size: 110 mm



02-3116 - 02-3119
STEVENS
Vessel and tendon Scissors
Size: 110 mm

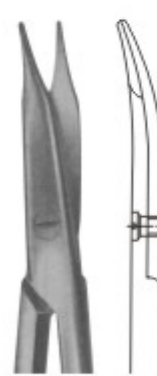

02-3117
Sharp

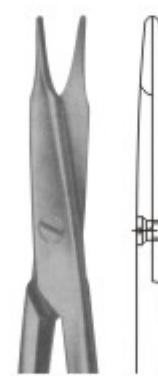

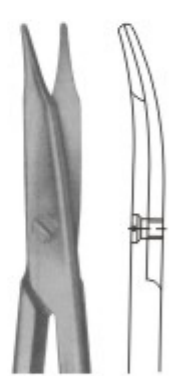

02-3118
Blunt

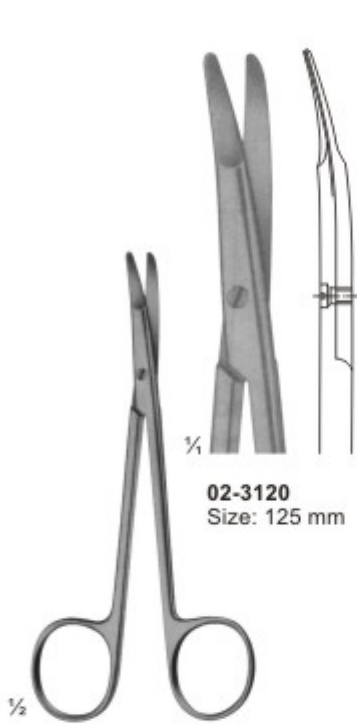
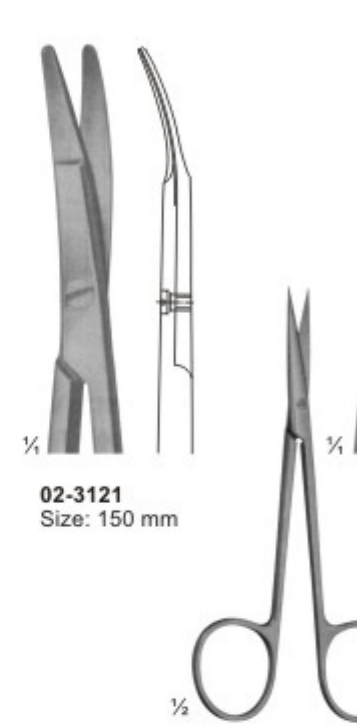
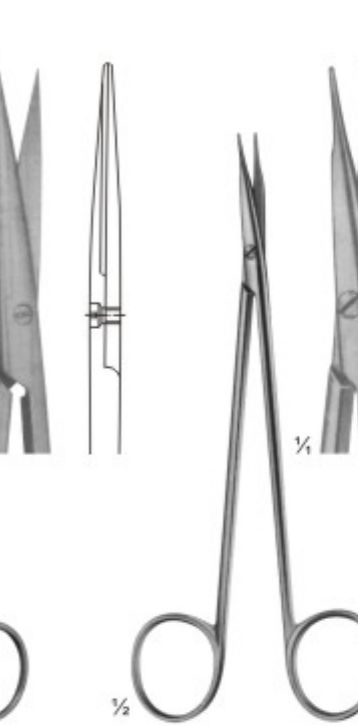
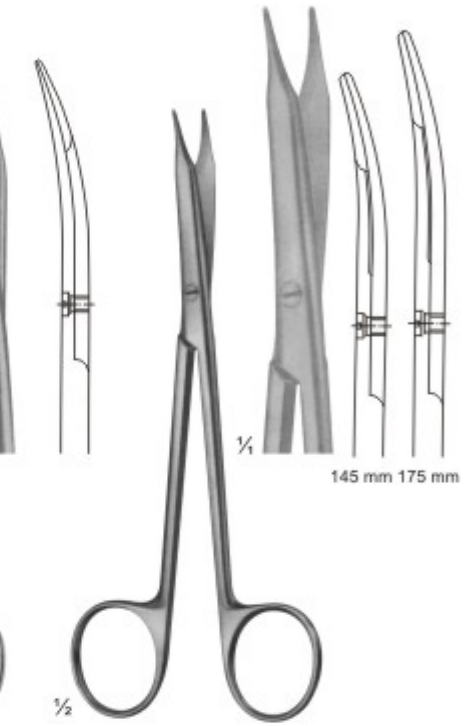
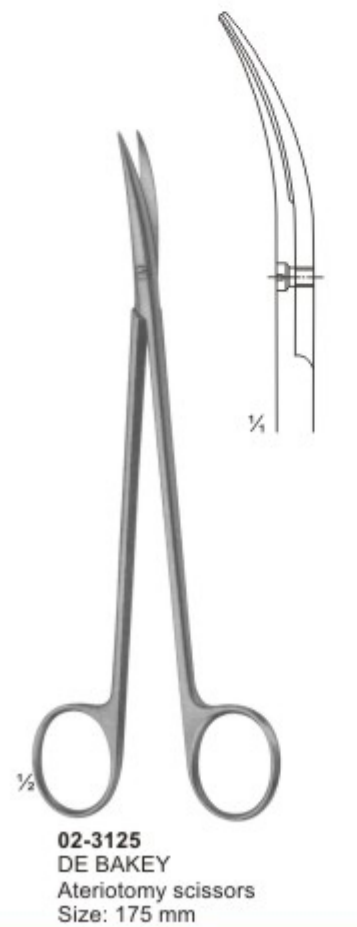

02-3119
Blunt

Dissecting Scissors

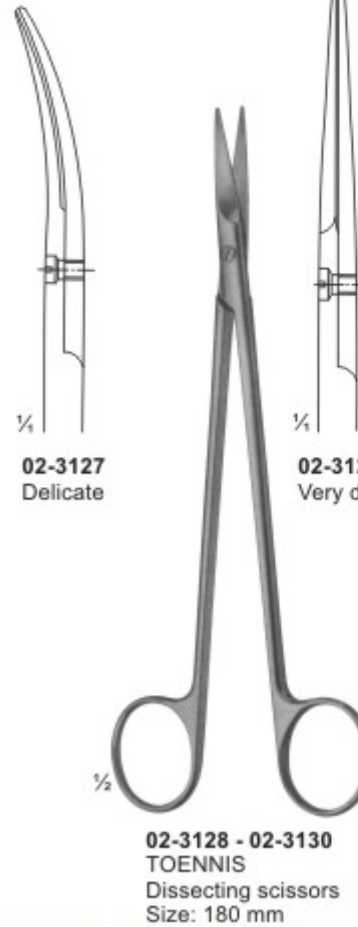
 <p>02-3120 Size: 125 mm</p> <p>02-3121 Size: 150 mm</p>	 <p>02-3122 Fine dissecting scissors Size: 115 mm</p>	 <p>02-3123 JAMESON Dissecting scissors Size: 150 mm</p>	 <p>02-3124 REYNOLDS Dissecting scissors</p> <p>145 mm 175 mm</p>
<p>02-3120 - 02-3121 KILNER Special flat points for dissecting and undermining the skin</p>  <p>02-3125 DE BAKEY Ateriotomy scissors Size: 175 mm</p>	 <p>02-3126 Very delicate</p> <p>02-3127 Delicate</p> <p>02-3126 - 02-3127 TOENNIS - ADSON Dissecting scissors Size: 175 mm</p>	 <p>02-3128 Very delicate</p> <p>02-3129 Delicate</p> <p>02-3130 Delicate</p> <p>02-3128 - 02-3130 TOENNIS Dissecting scissors Size: 180 mm</p>	

Dissecting & Surgical Scissors



02-3131
Size: 115 mm



02-3132
Size: 135 mm

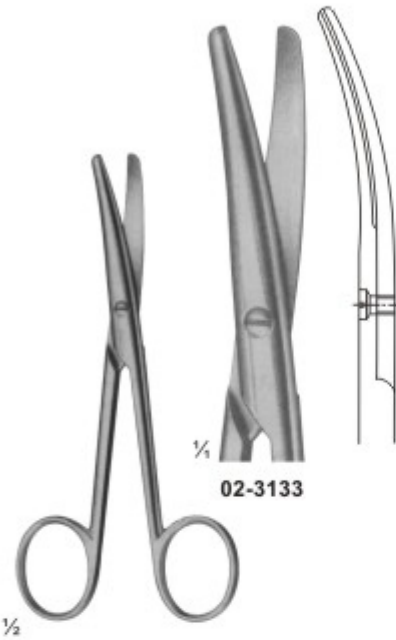

02-3133



02-3134

02-3133 - 02-3134
LANDOLT
Enucleation scissors
Size: 120 mm

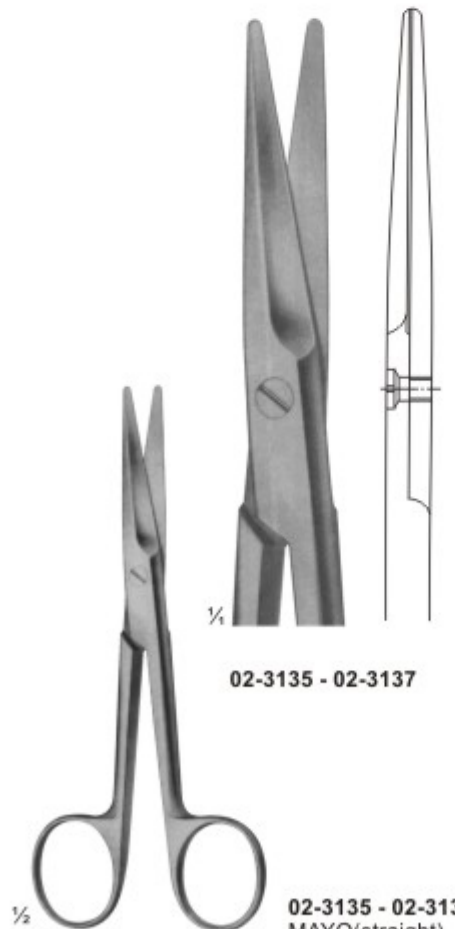

02-3135 - 02-3137

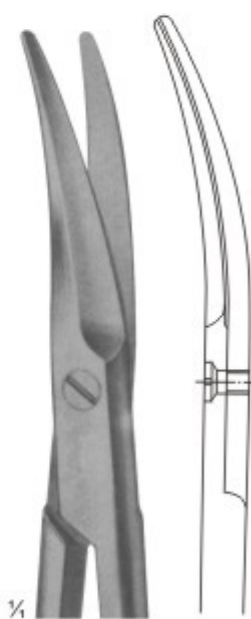

02-3138 - 02-3140
MAYO(curved)
02-3138 (140 mm)
02-3139 (155 mm)
02-3140 (170 mm)

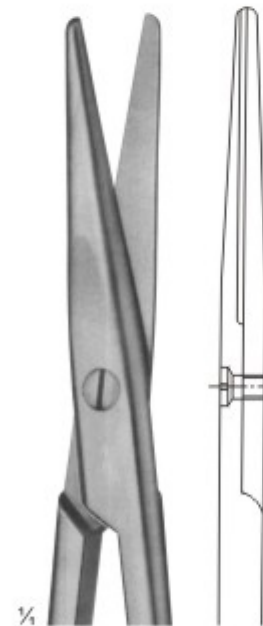

02-3141 - 02-3142



02-3143 - 02-3144
MAYO-STILLE(curved)
02-3143 (140 mm)
02-3144 (170 mm)

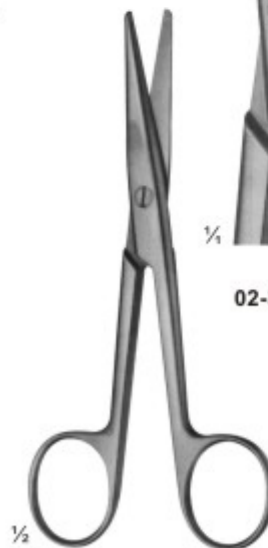

02-3141 - 02-3142
MAYO-STILLE(straight)
02-3141 (140 mm)
02-3142 (170 mm)

Dissecting Scissors

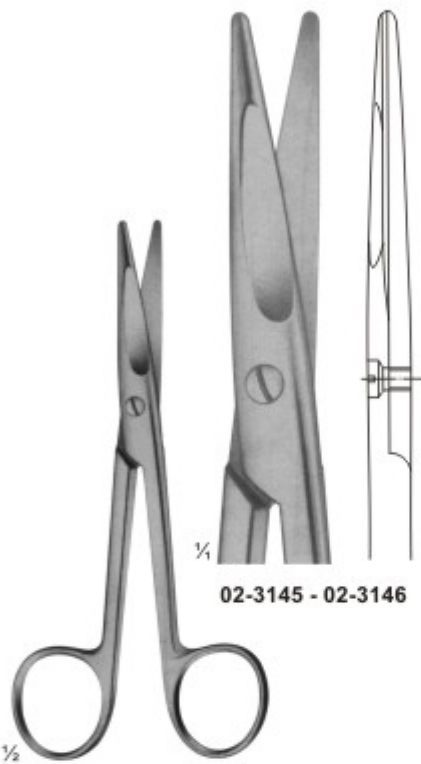

02-3145 - 02-3146

02-3145 - 02-3146
MAYO-STILLE
With chamfered blades
02-3145 (140 mm)
02-3146 (170 mm)

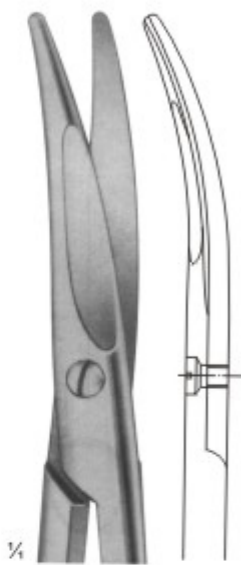

MAYO-STILLE
02-3147 - 02-3148
02-3147(14cm)
02-3148(17cm)

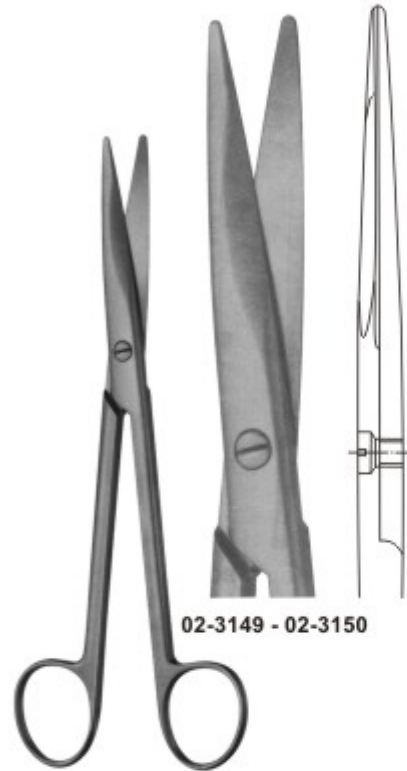

02-3149 - 02-3150

MAYO
With chamfered blades
02-3149 (190 mm)
02-3150 (215 mm)

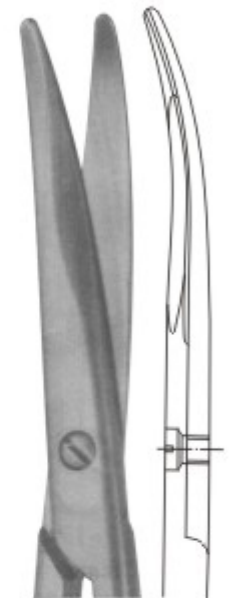

MAYO
02-3151
Size: 190 mm
02-3152
Size: 215 mm

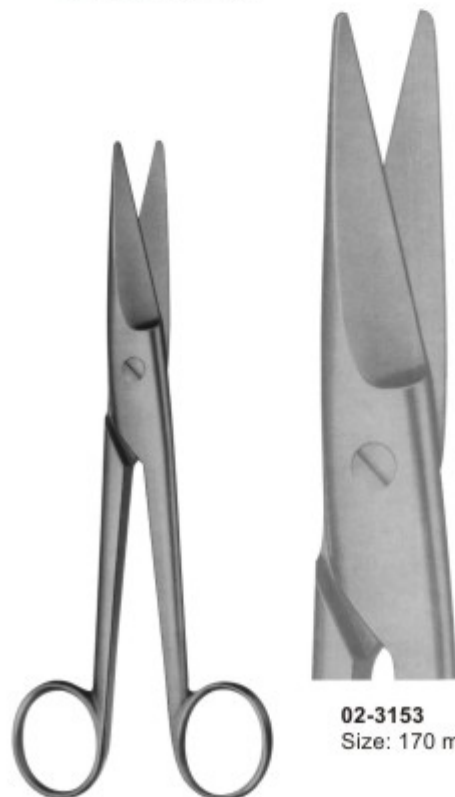

02-3153
Size: 170 mm

02-3154
Size: 170 mm

02-3153 - 02-3154
MAYO-NOBLE (Broad pattern)



02-3155
Size: 230 mm

02-3156
Size: 230 mm

02-3155 - 02-3156
MAYO-HARRINGTON

Dissecting Scissors

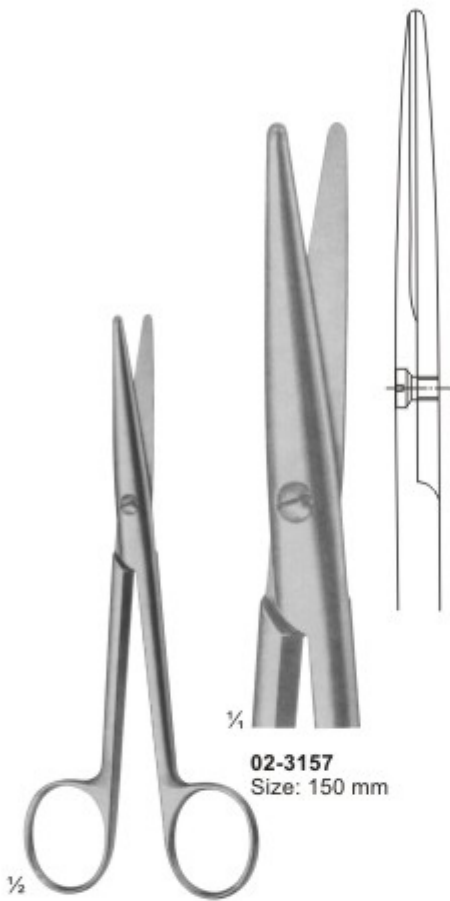

02-3157
Size: 150 mm

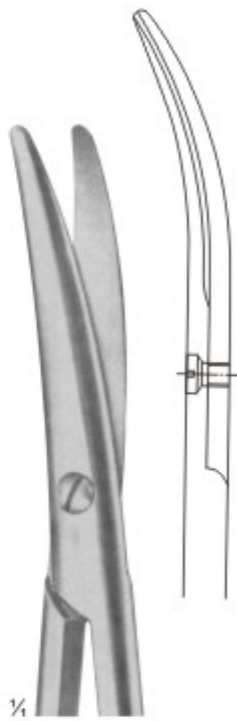

02-3158
Size: 150 mm

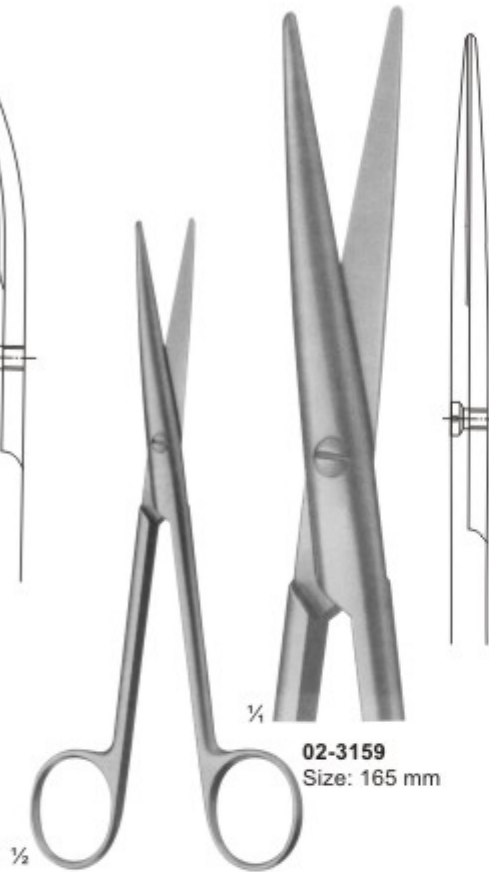

02-3159
Size: 165 mm



02-3160
Size: 165 mm

02-3157 - 02-3158
STILLE

02-3159 - 02-3160
LEXER
Narrow

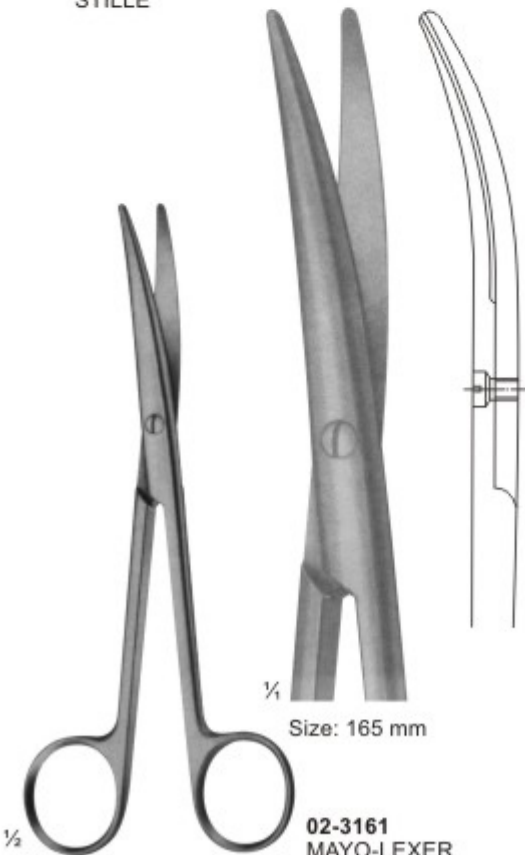

Size: 165 mm

02-3161
MAYO-LEXER
Standard

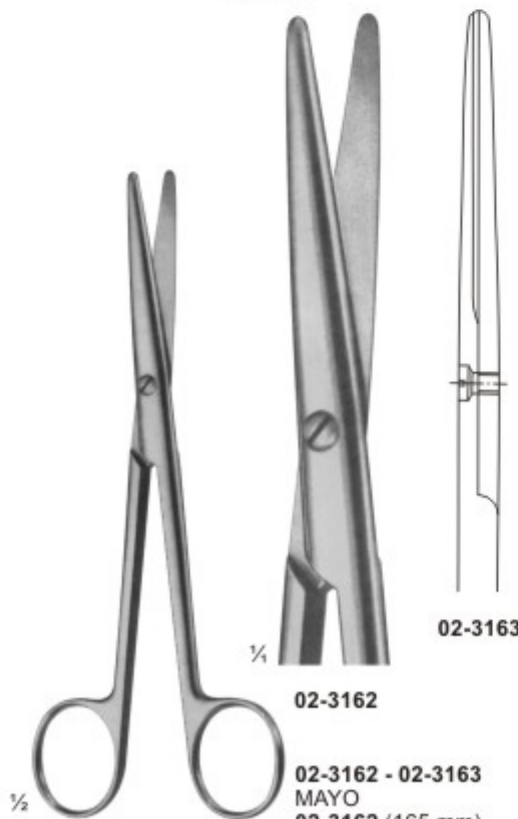

02-3162

02-3162 - 02-3163
MAYO
02-3162 (165 mm)
02-3163 (200 mm)



MAYO
02-3164
Size: 165 mm

02-3165
Size: 200 mm
02-3166
Size: 210 mm

Dissecting Scissors

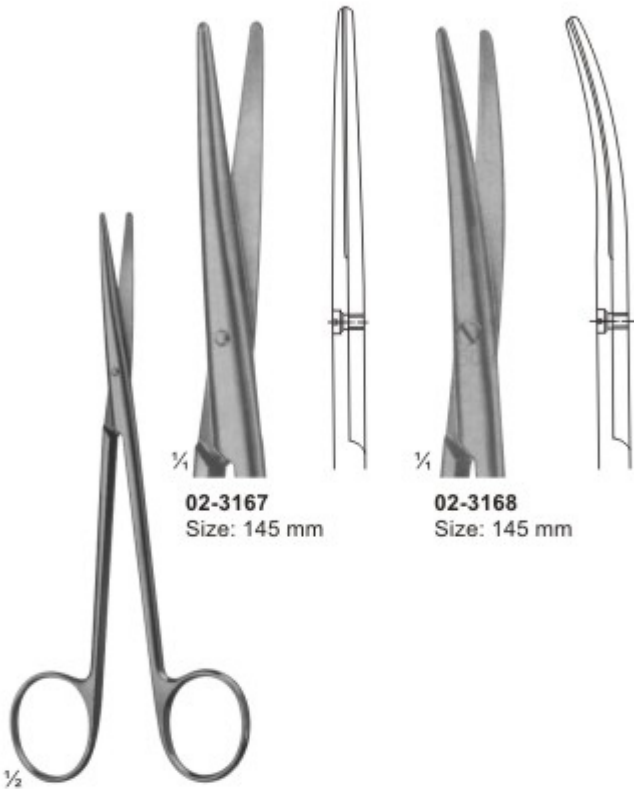

02-3167
Size: 145 mm

02-3168
Size: 145 mm

02-3167 - 02-3168
BABY - METZENBAUM

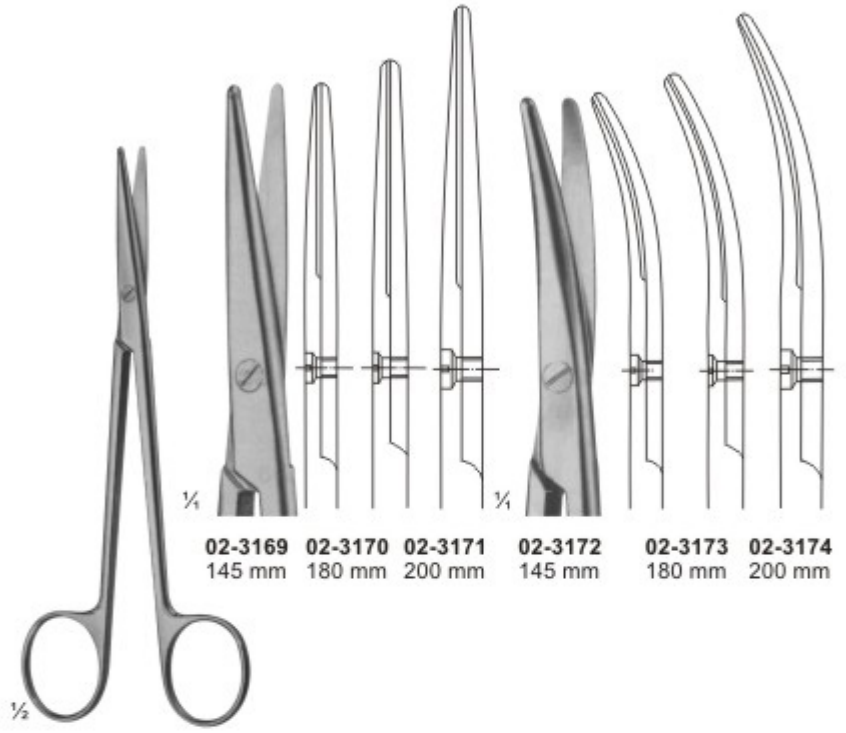

02-3169
145 mm

02-3170
180 mm

02-3171
200 mm

02-3172
145 mm

02-3173
180 mm

02-3174
200 mm

02-3169 - 02-3174
METZENBAUM



02-3175 - 02-3182
NELSON
METZENBAUM

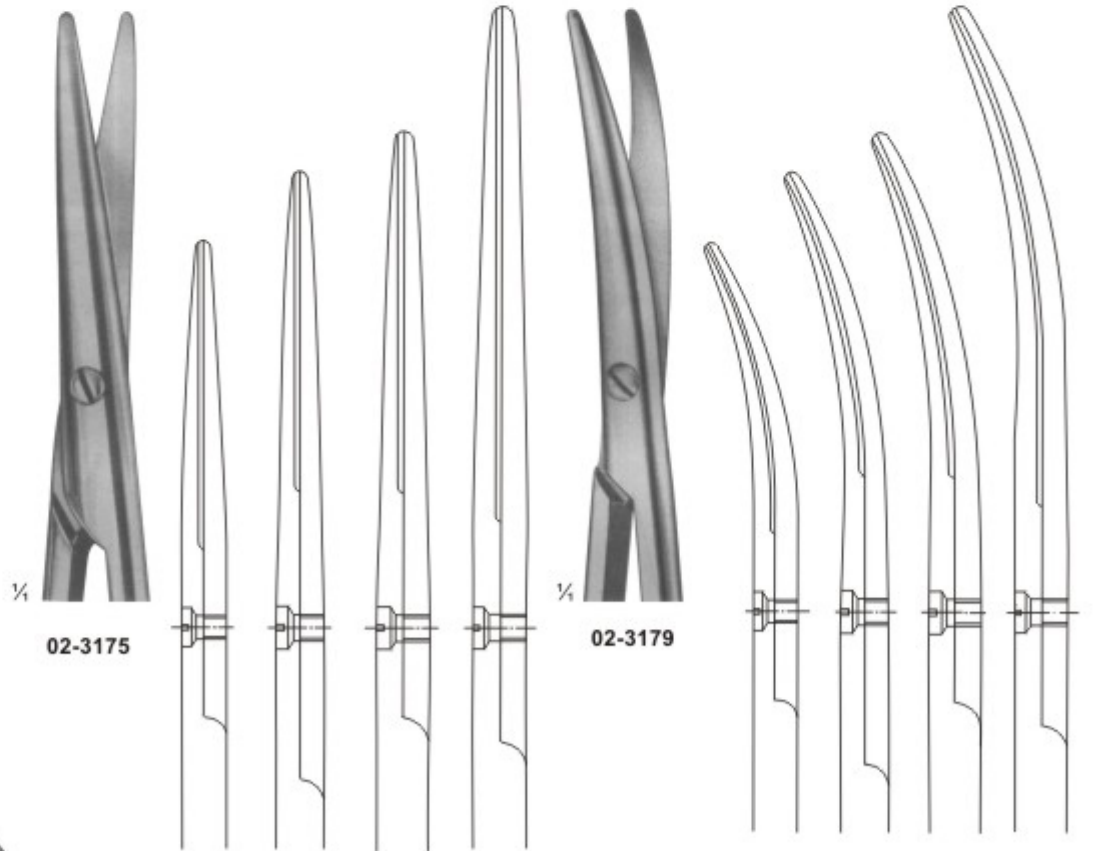

02-3175

02-3179

02-3175
230 mm

02-3176
250 mm

02-3177
280 mm

02-3178
305 mm

02-3179
230 mm

02-3180
250 mm

02-3181
280 mm

02-3182
305 mm

Vessel Scissors

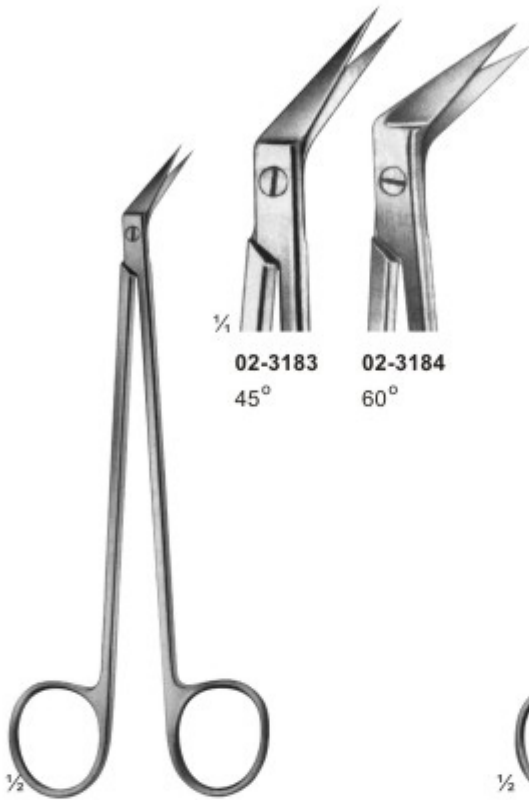

02-3183
45°

02-3184
60°

02-3183 - 02-3184
DE BAKKEY
Size: 155 mm

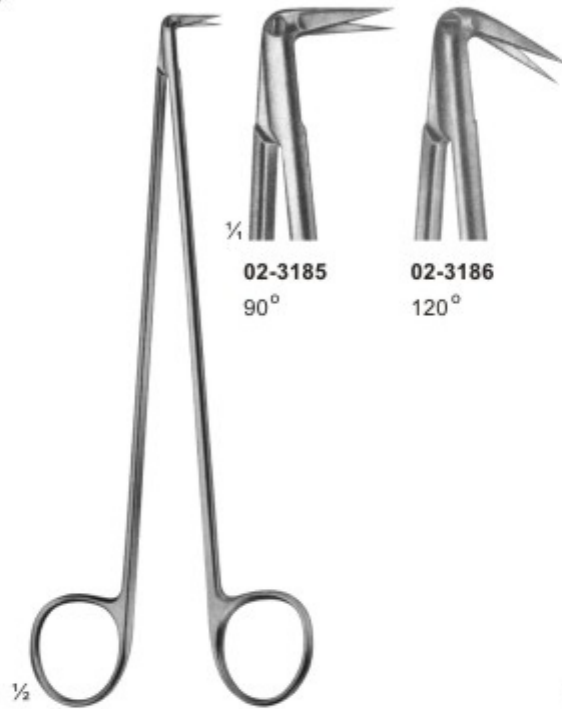

02-3185
90°

02-3186
120°

02-3185 - 02-3186
DIETRICH
Size: 170 mm

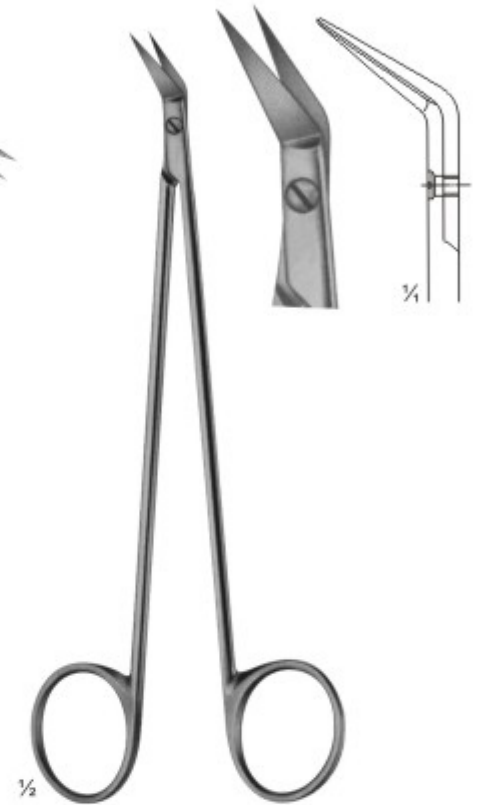

02-3187
POTTS-SMITH
Size: 180 mm
55° Angled on Flat



02-3188
60°

02-3188
POTTS-SMITH
Size: 180 mm

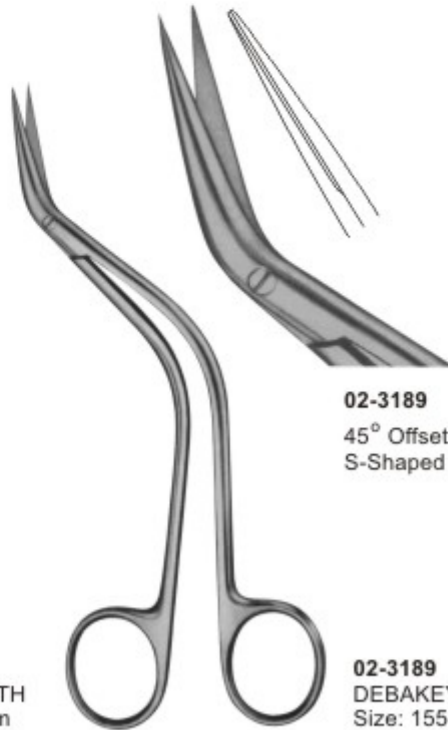

02-3189
45° Offset Scissors
S-Shaped

02-3189
DEBAKEY
Size: 155 mm



02-3190
55°

02-3190
FAVOLORO
Coronary Artery
Scissors
Size: 140 mm

Cardiovascular and Neuro-Surgery Scissors

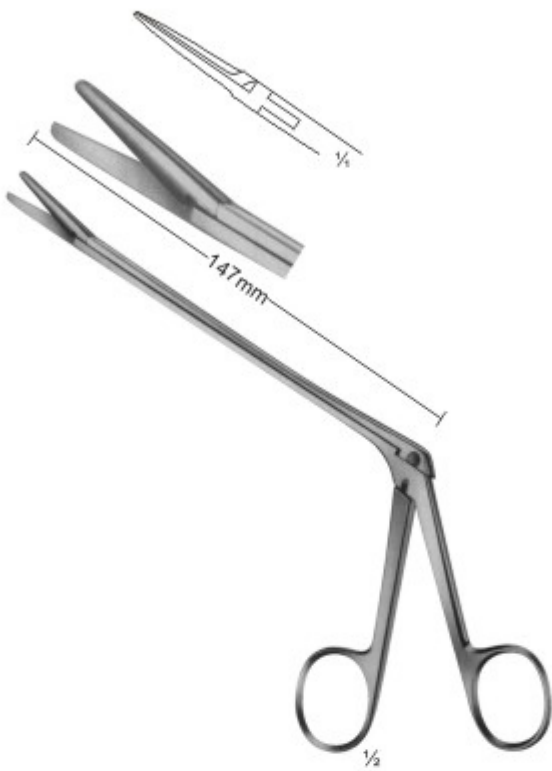

02-3191
OLIVECRONA
Dura Scissors

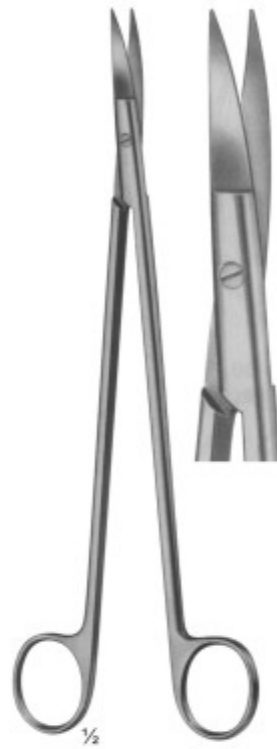

02-3192
STRULLY
Pointed
Size: 220 mm

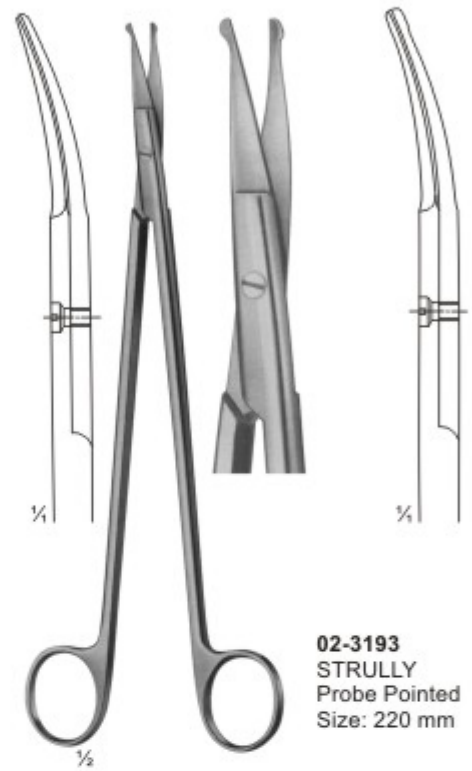

02-3193
STRULLY
Probe Pointed
Size: 220 mm

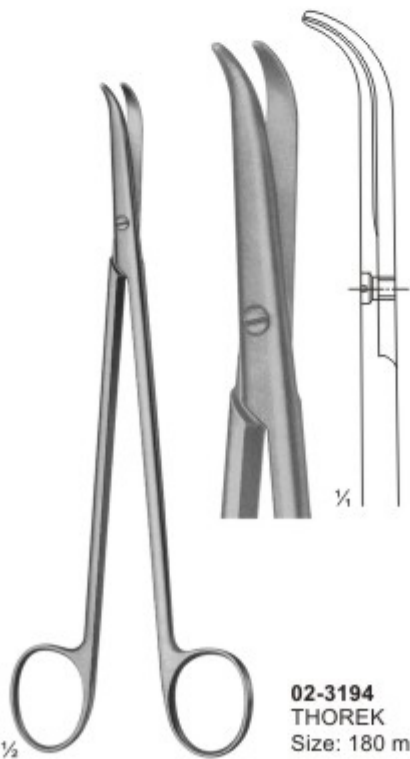

02-3194
THOREK
Size: 180 mm

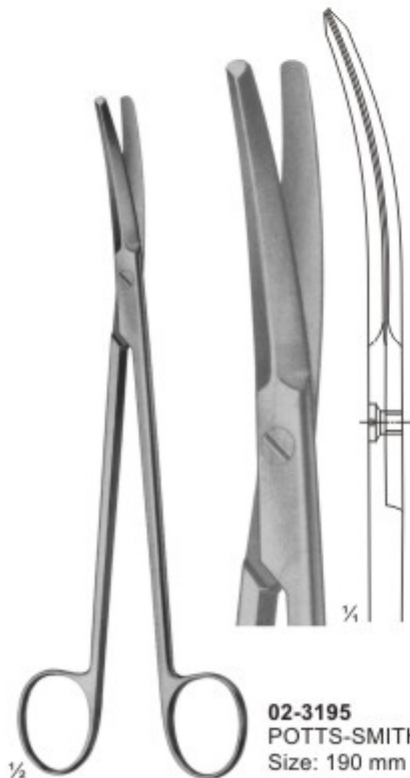

02-3195
POTTS-SMITH
Size: 190 mm

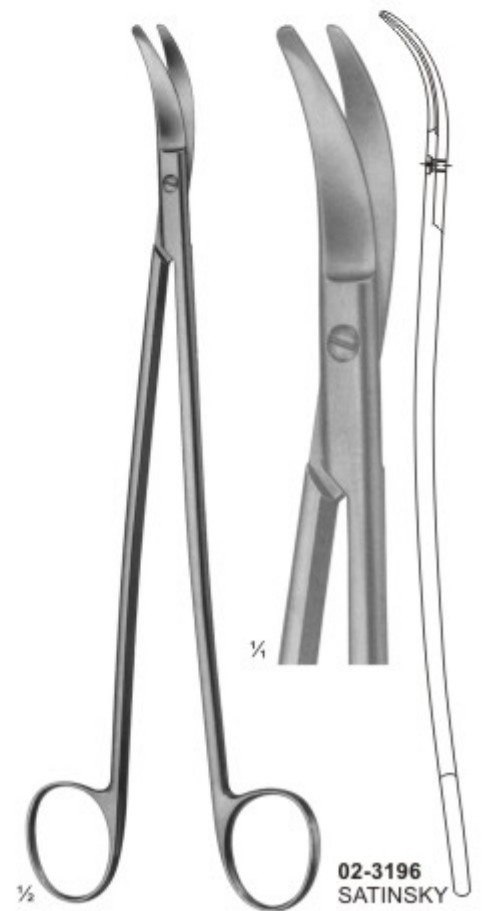

02-3196
SATINSKY
Size: 245 mm

Delicate, Nasal and Tonsil Scissors



02-3197
1 Finely Toothed Blade
Size: 130 mm

02-3198
LOCKLIN
Curved Sideways,
1 Toothed Blade
Size: 155 mm

02-3199
FOMON
Blades Serrated
Size: 145 mm

02-3200
COTTLE
Size: 165 mm

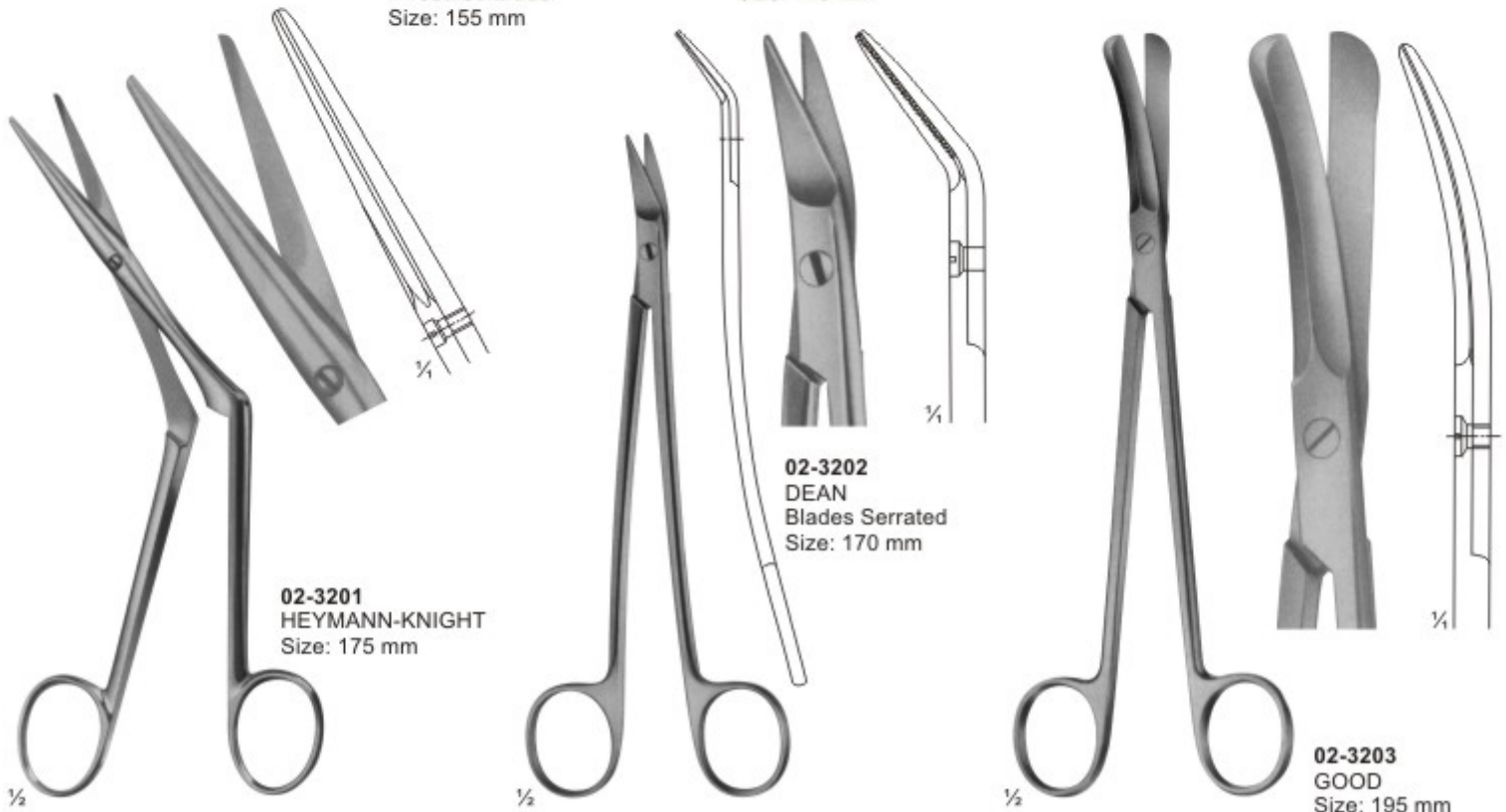

02-3201
HEYMANN-KNIGHT
Size: 175 mm

02-3202
DEAN
Blades Serrated
Size: 170 mm

02-3203
GOOD
Size: 195 mm

Bone Shears



02-3204
KILLIAN
Size: 200 mm



02-3205 - 02-3206



02-3205
195 mm

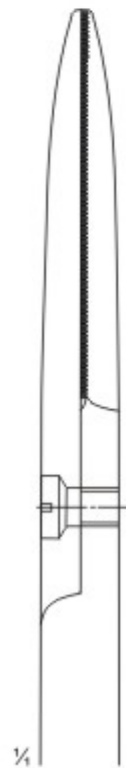

02-3206
225 mm



Operating and Gynaecology Scissors

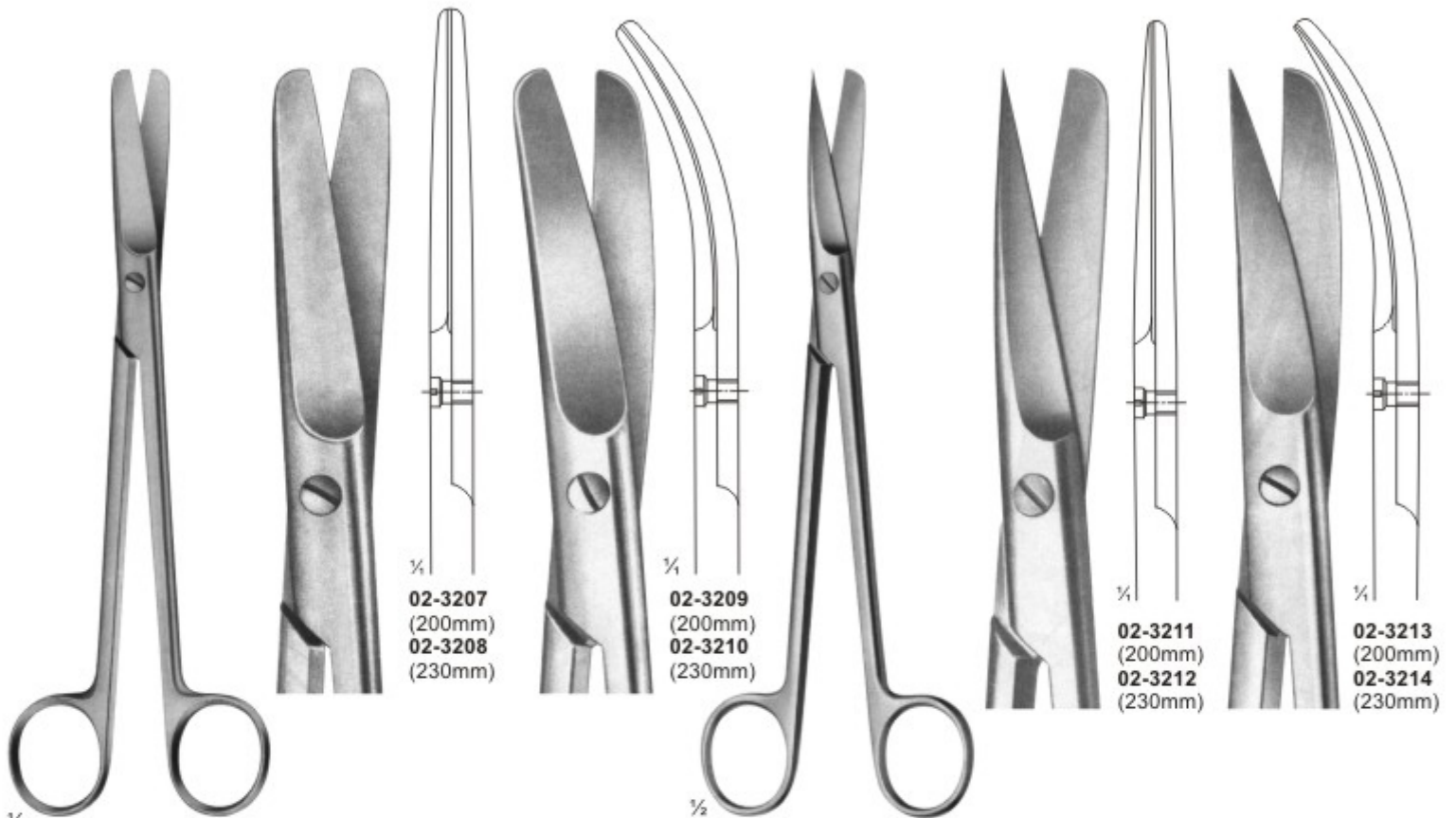

02-3207 - 02-3210
SIMS

02-3211 - 02-3214
SIMS



02-3215
SIMS

02-3216
SIMS

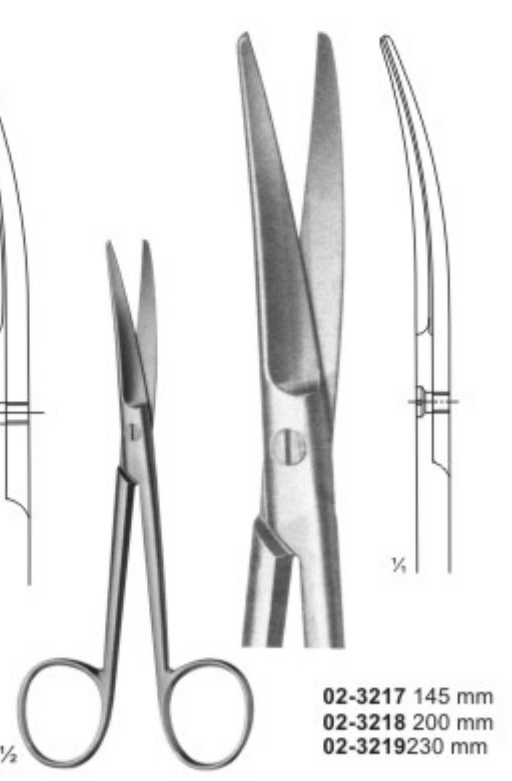

02-3217 - 02-3219
WERTHEIM

02-3217 145 mm
02-3218 200 mm
02-3219 230 mm

Operating and Gynaecology Scissors

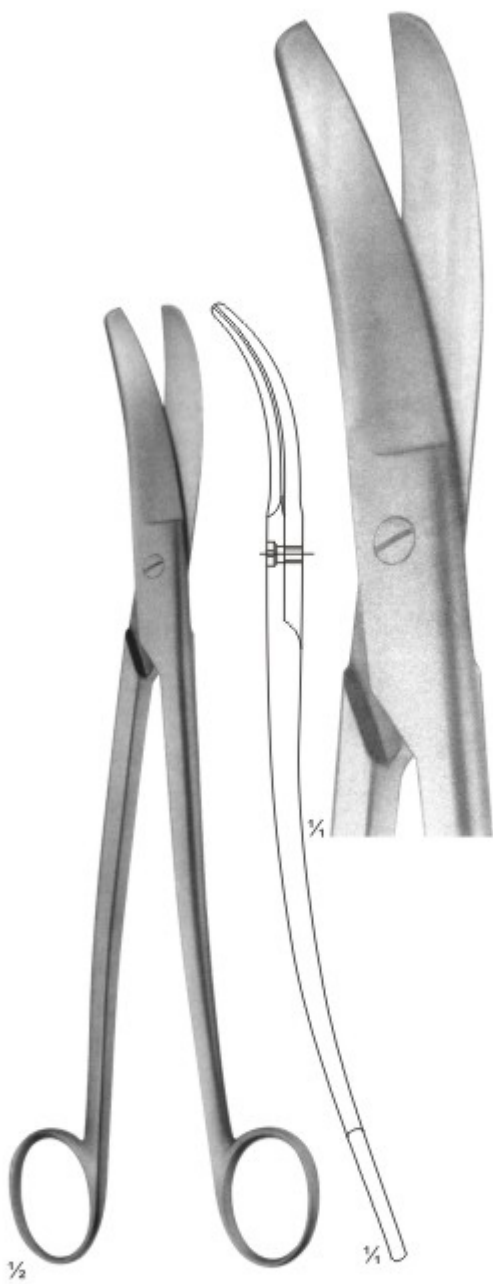

02-3220
SIEBOLD
Uterine Scissors
Size: 245 mm

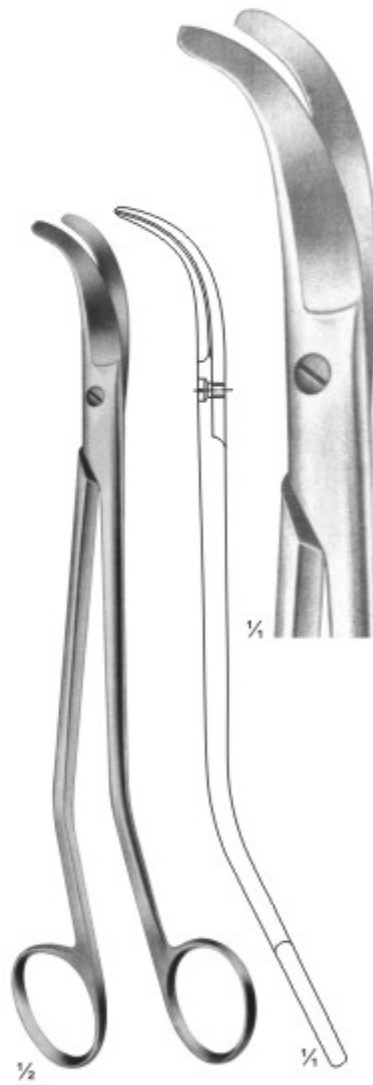

02-3221
BOZEMANN
Uterine Scissors
Size: 220 mm

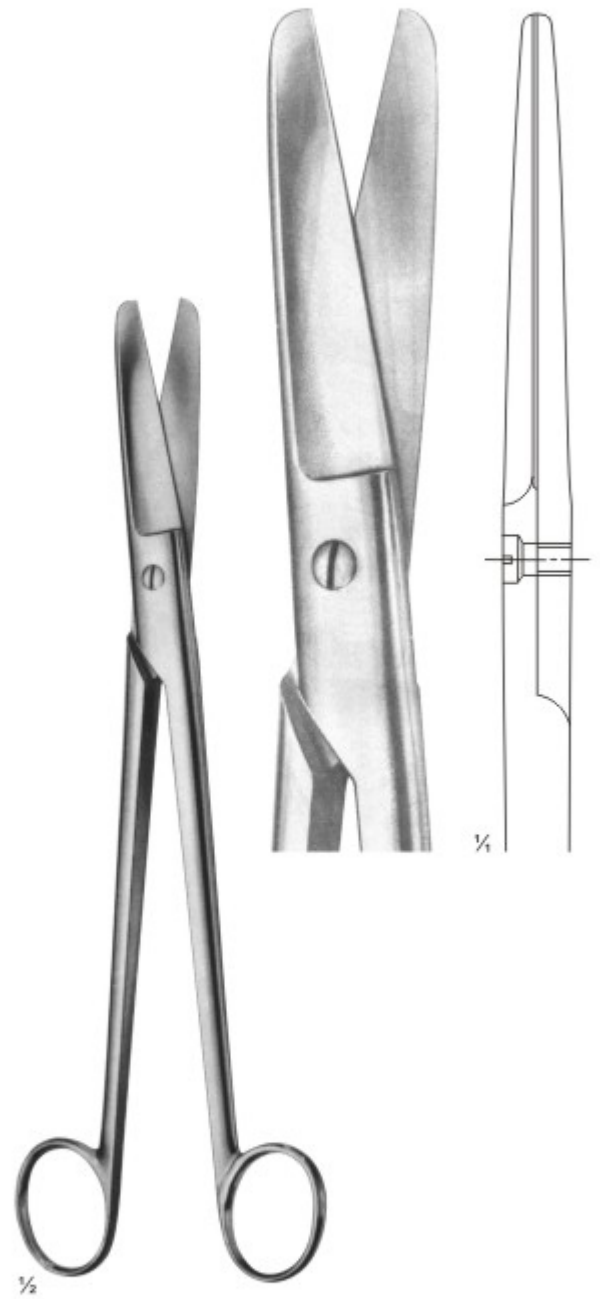

02-3222
SIMS-SIEBOLD
Uterine Scissors
Size: 250 mm

Scissors For Obstetrics



02-3223
SCHUMACHER
Umbilical Cord Scissors
Size: 155 mm



02-3224
Umbilical Cord Scissors
Size: 105 mm



02-3225
Umbilical Cord Scissors

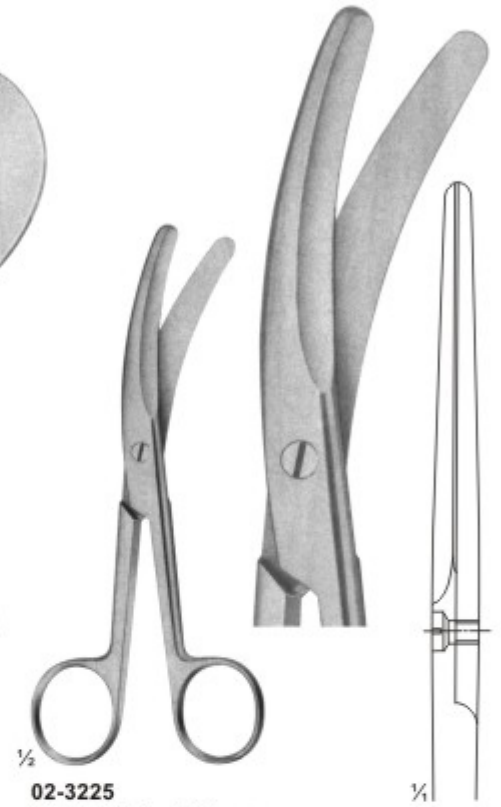

135 mm



02-3226 - 02-3227
BRAUN-STADLER
Episiotomy Scissors

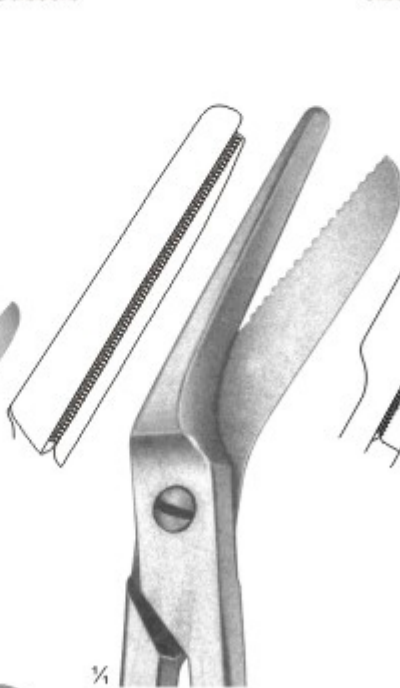

02-3226
145 mm

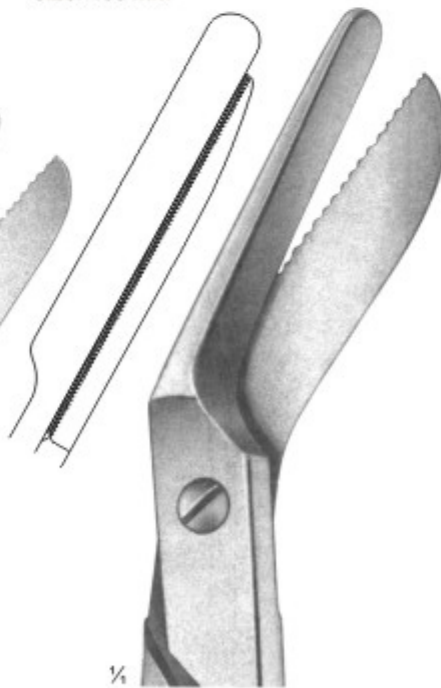

02-3227
200 mm



02-3228
Episiotomy Scissors
240 mm



Bowel Scissors, Rectal Scissors

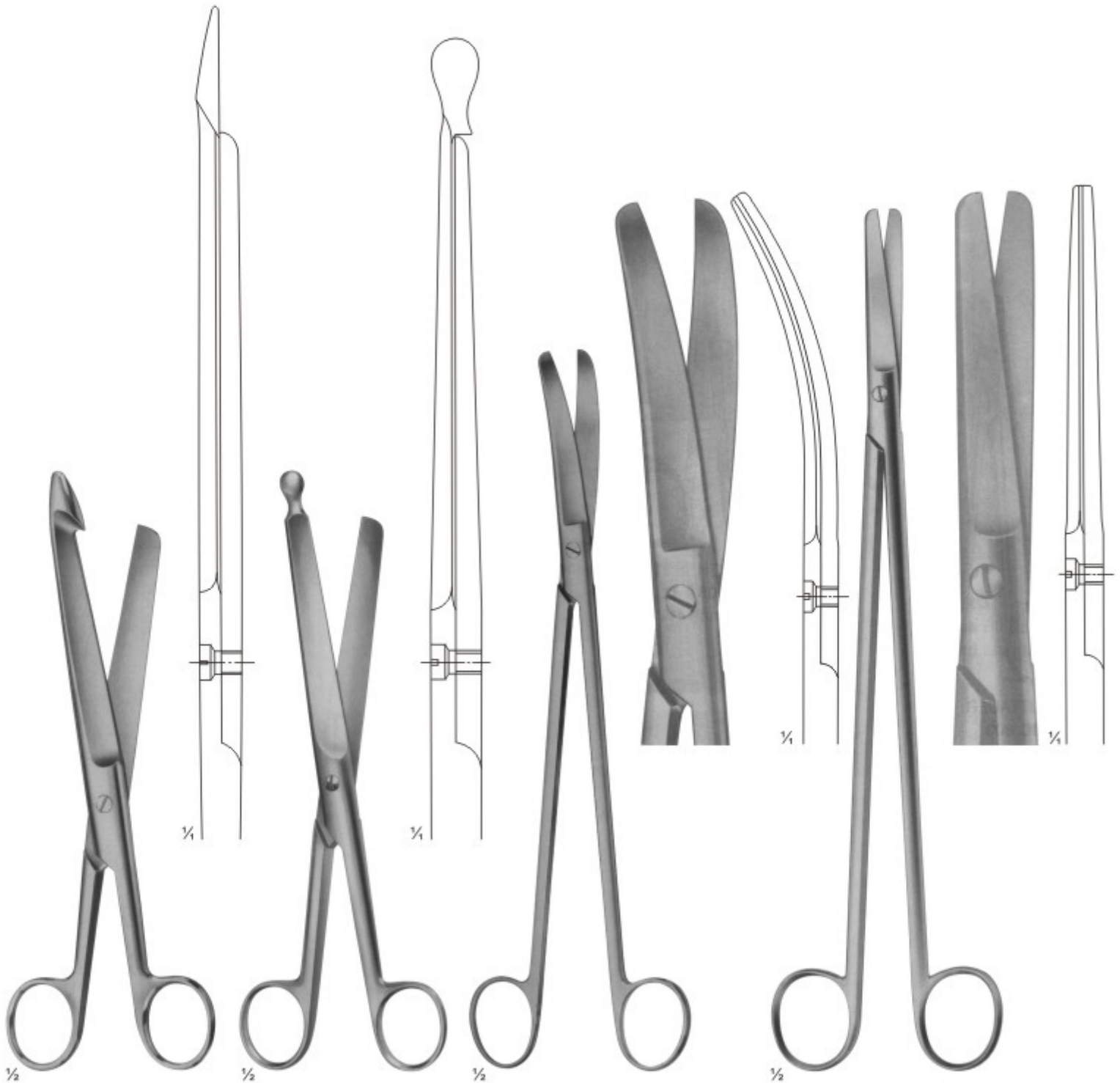

02-3229
Bowel Scissors
Size: 210 mm

02-3230
Bowel Scissors
Size: 210 mm

02-3231
LLOYD-DAVIES
(GOLIGHER'S)
Rectal Scissors
Size: 270 mm

02-3232
STELZNER
Rectal Scissors
Size: 310 mm

Ligature Scissors

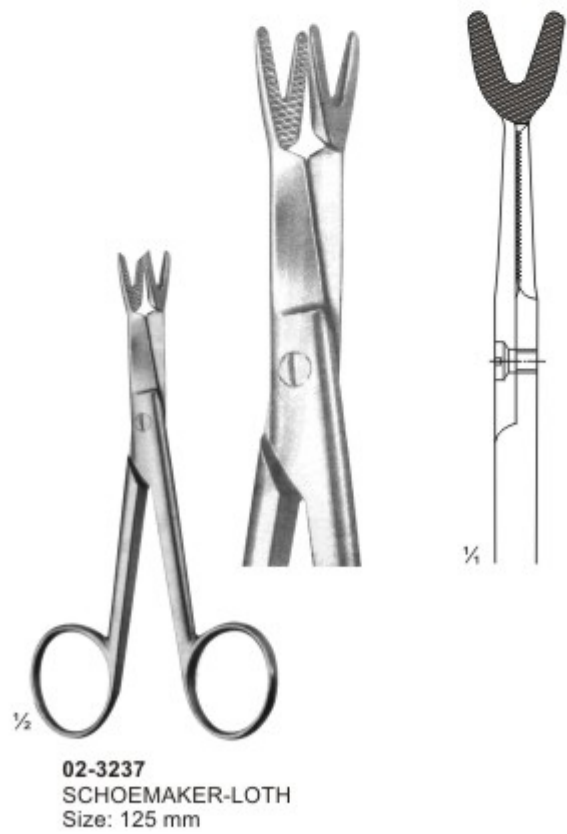
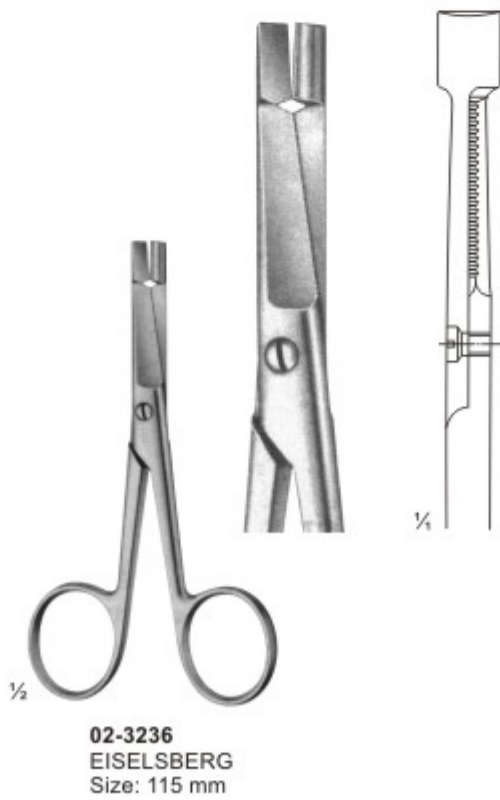
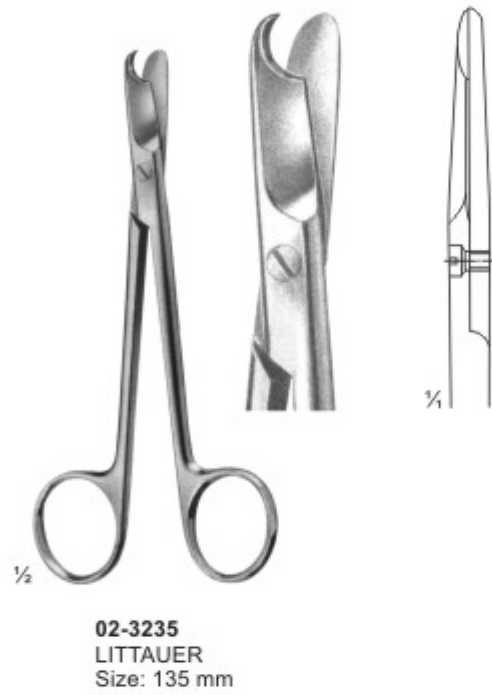

Wire and Plate Scissors



½

02-3238 - 02-3242
BEEBE
Size: 110 mm

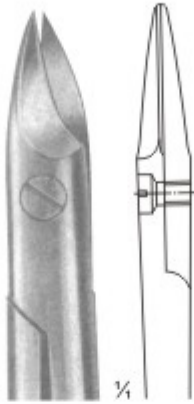

02-3238

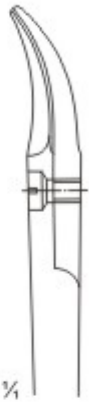

02-3239

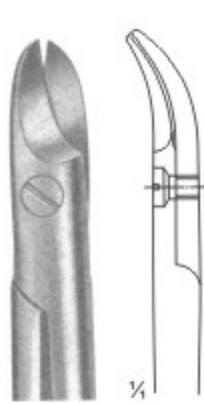

02-3240
Broad Blades

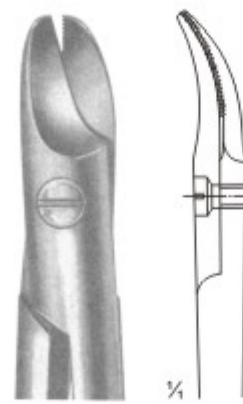

02-3241
1 Blade Serrated

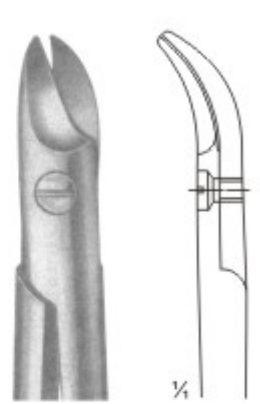

02-3242
NAUJOKS
Strongly Curved

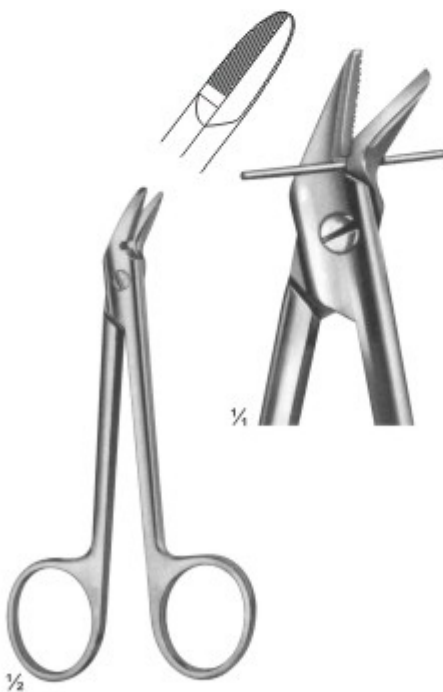

½

02-3243
1 Blade Serrated
Size: 120 mm



½

02-3244
STRACK
Size: 100 mm

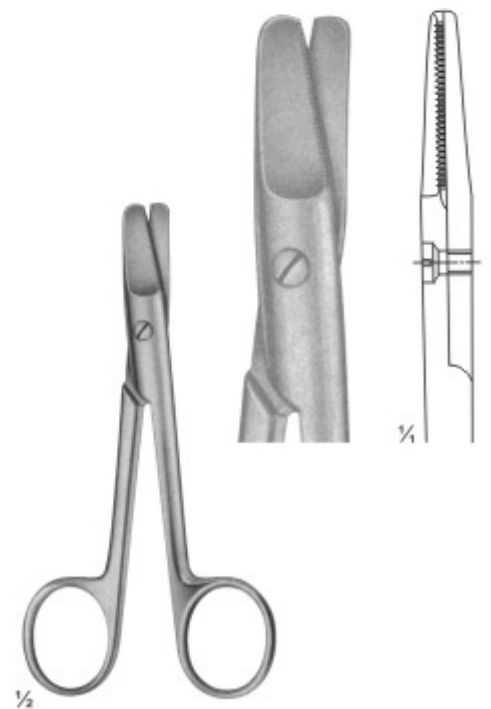

½

02-3245
HARVEY
blades serrated
Size: 125 mm

Nail and Bandage Scissors

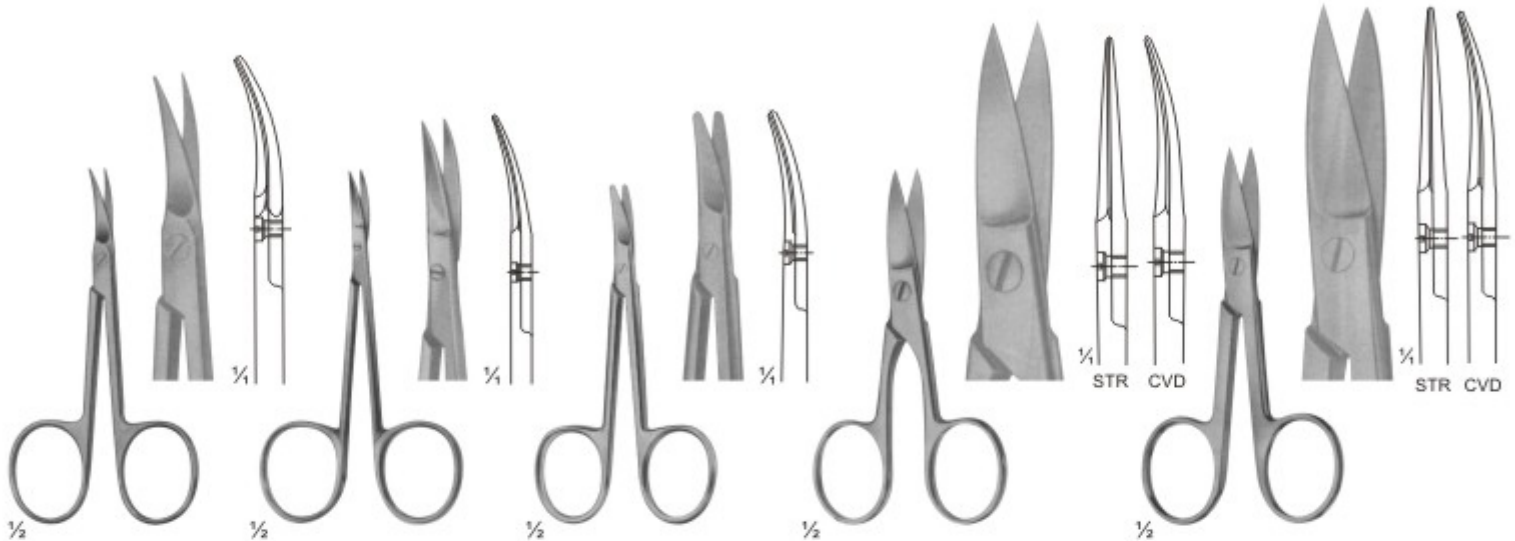

02-3246
NAIL SCISSORS
Size: 90 mm

02-3247
NAIL SCISSORS
especially fine pattern
Size: 90 mm

02-3248
BABY NAIL
SCISSORS
Size: 85 mm

02-3249 - 02-3252
NAIL SCISSORS
02-3249(90mm)straight
02-3250(90mm)curved
02-3251(100mm)straight
02-3252(110mm)curved

02-3253 - 02-3255
NAIL SCISSORS
02-3253(95mm)straight
02-3254(95mm)curved
02-3255(105mm)straight



02-3256
KNOWLES
Size: 140 mm

02-3257
KNOWLES
Size: 145 mm

02-3258
Size: 150 mm

02-3259
SMITH
Size: 180 mm

02-3260
BANDAGE CUTTING
SCISSORS
Size: 310 mm

Bandage and Cloth Scissors



1/2
02-3261
 UNIVERSAL BANDAGE & CLOTH SCISSORS,
 WITH TOOTHED EDGES, AUTO CLEAVABLE up to 143 °C
 180 mm



1/2
02-3262
 LISTER BANDAGE & CLOTH
 SCISSORS, WITH TOOTHED EDGES,
 AUTO CLEAVABLE up to 143 °C
 Size: 145 mm

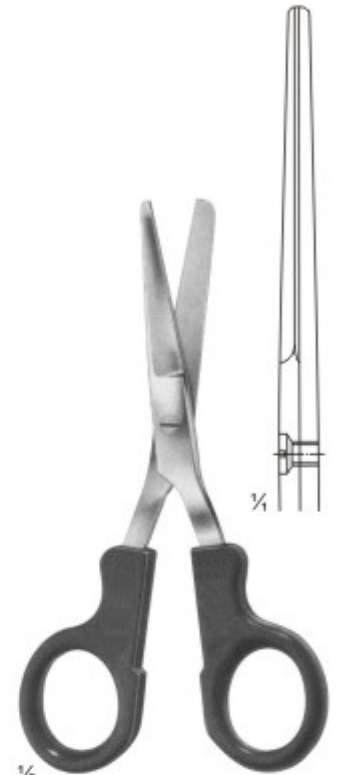

1/2
02-3263
 NURSE'S SCISSORS
 Size: 145 mm
 AUTO CLEAVABLE up to 143 °C

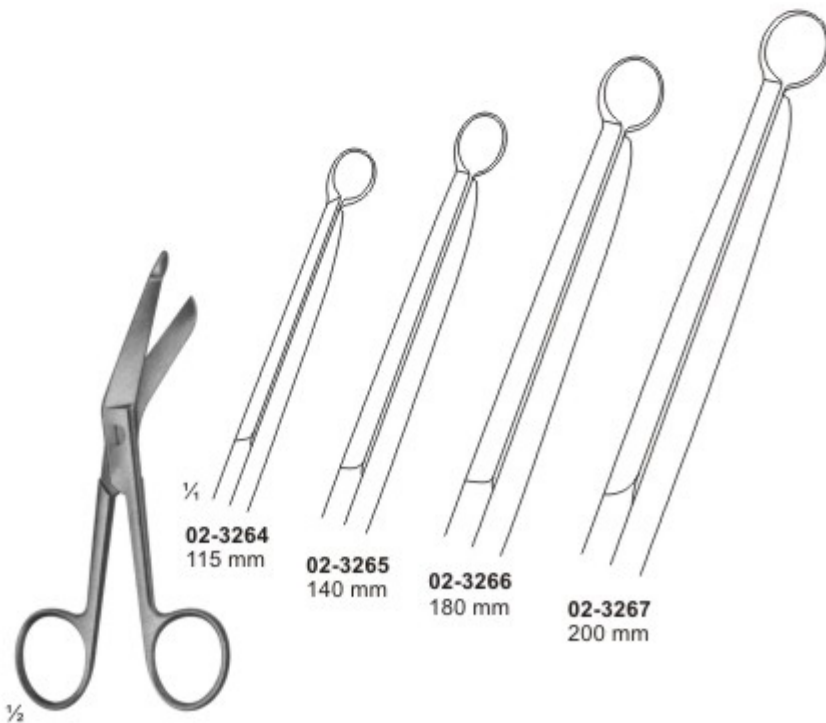

1/2
02-3264 - 02-3267
 LISTER

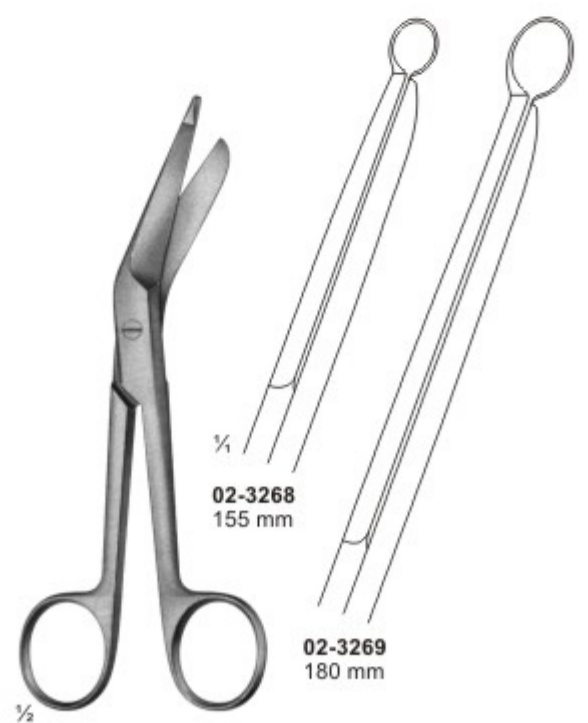

1/2
02-3268 - 02-3269
 LISTER

Bandage, Cloth and Plaster Scissors



02-3270
CLOTH SCISSORS
205 mm

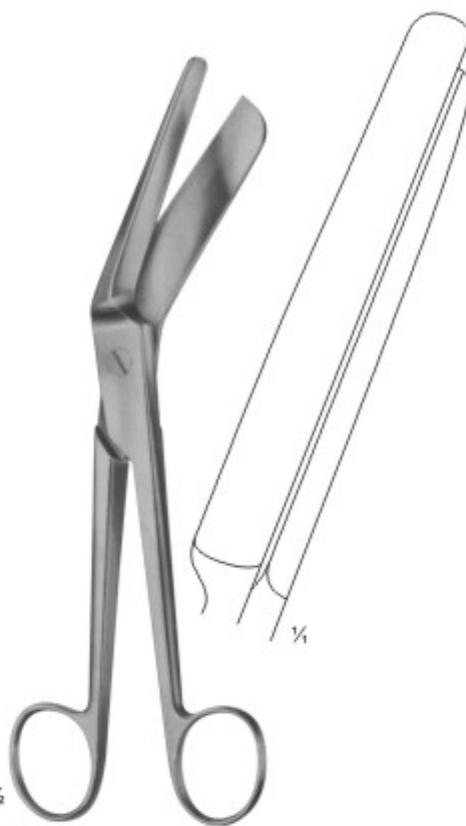

02-3271
BRAUN-STADLER
Bandage scissors
225 mm



02-3272
SEUTIN
Plaster scissors
230 mm



02-3273 - 02-3274
ESMARCH (Plaster scissors)

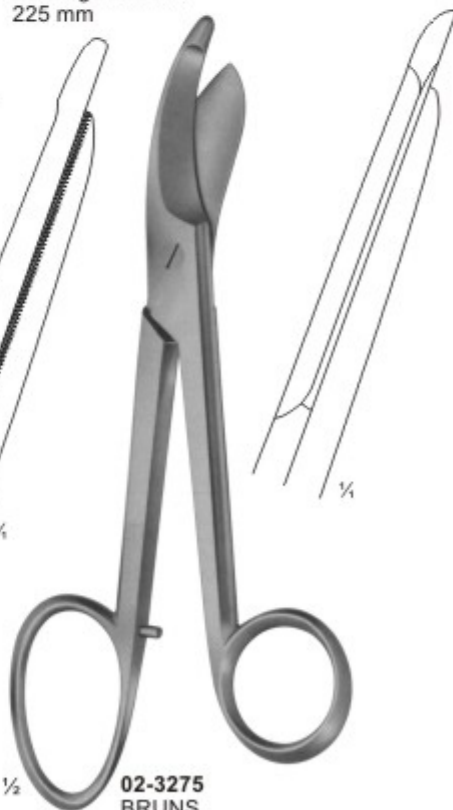

02-3275
BRUNS
Plaster scissors
235 mm



02-3276
BANDAGE SCISSORS
235 mm

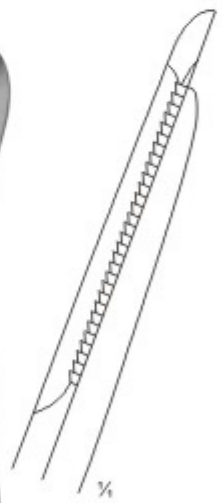

Micro Forceps, Jeweler Types and Micro Suture Tying Forceps

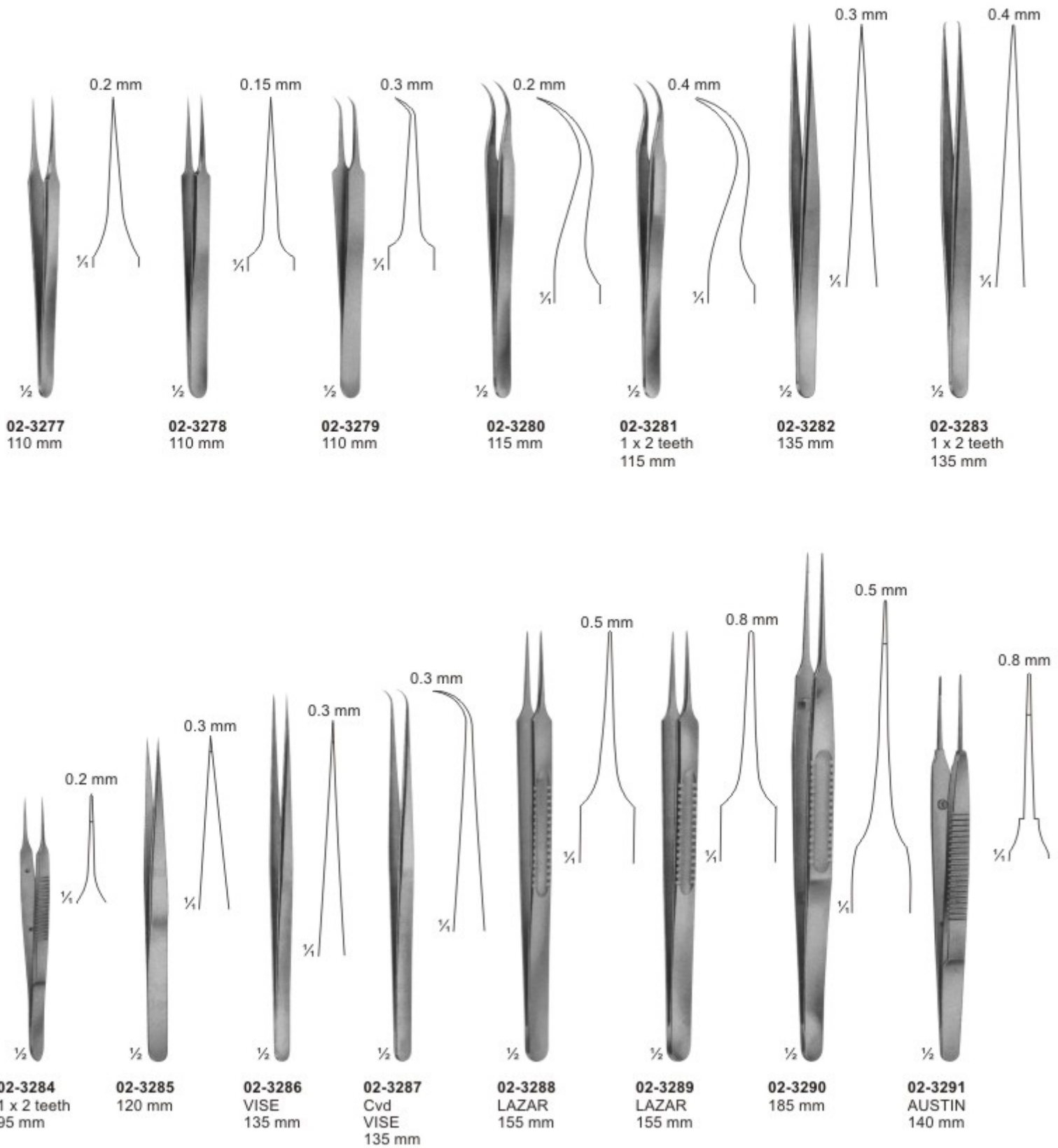

Micro Forceps, Ligature Forceps (Light Patterns) Bayonet - Shaped

0.15 mm 0.20 mm 0.30 mm 0.50 mm

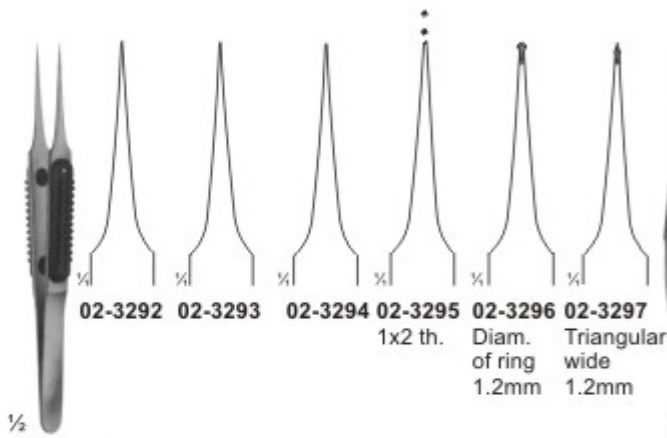

02-3292 - 02-3297
MULLER
110 mm



02-3298
LIGATURE
FORCEPS
220 mm



02-3299
YASARGIL
Ligature forceps
185 mm

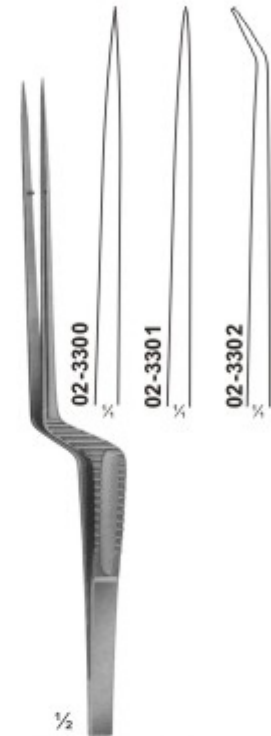

02-3300 - 02-3302
MICRO FORCEPS
Ligature pattern
185 mm

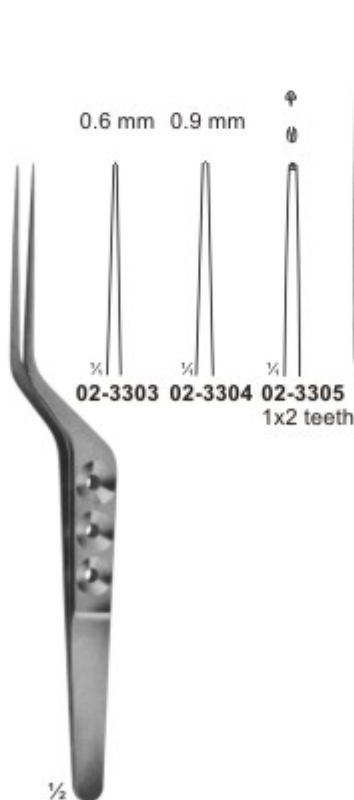

02-3303 - 03-3305
YASARGIL
180 mm



02-3306 - 02-3307
YASARGIL
200 mm



02-3308 - 03-3309
YASARGIL
220 mm



02-3309



02-3310 - 02-3311
YASARGIL
240 mm

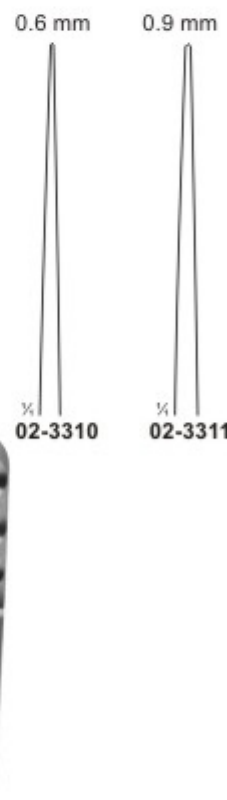

02-3310 - 02-3311
YASARGIL
240 mm

Forceps for Grasping Tissue, Tumors, Bayonet Shaped

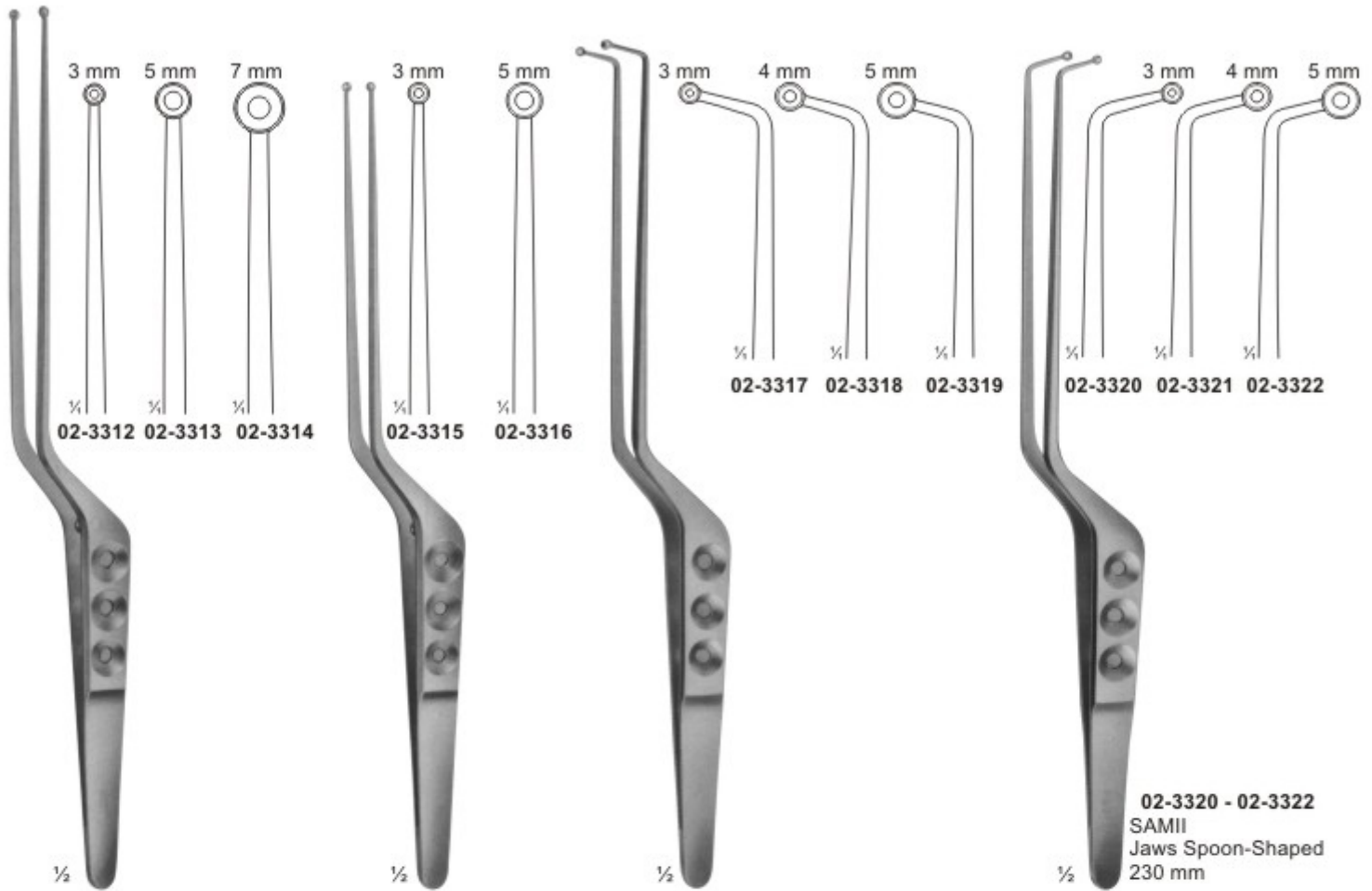

02-3312 - 02-3314
YASARGIL-SAMII
Jaws Spoon-Shaped
240 mm

02-3315 - 02-3316
YASARGIL
Jaws Spoon-Shaped
220 mm

02-3317 - 02-3319
SAMII
Jaws Spoon-Shaped
230 mm

02-3320 - 02-3322
SAMII
Jaws Spoon-Shaped
230 mm

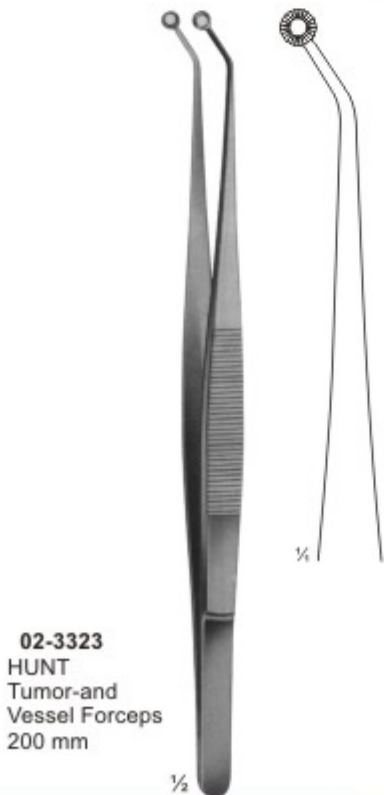

02-3323
HUNT
Tumor-and
Vessel Forceps
200 mm

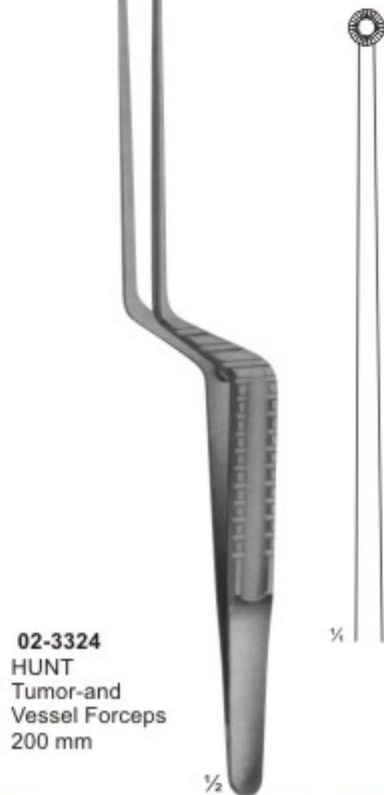

02-3324
HUNT
Tumor-and
Vessel Forceps
200 mm



02-3325
YASARGIL
Tumor-and
Vessel Forceps
200 mm

Delicate Dissecting, Microscopic, Sterilizing Forceps

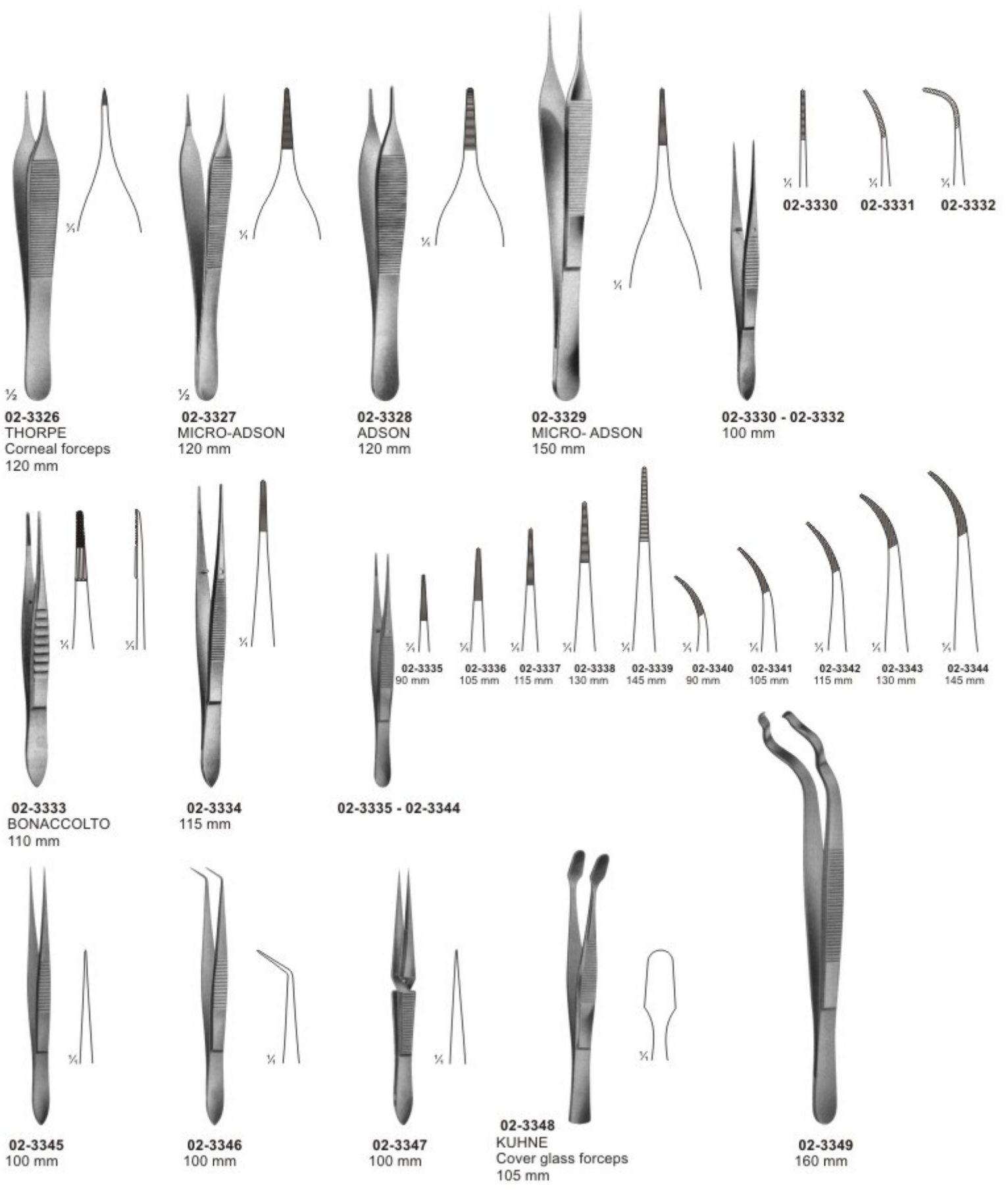

02-3326
THORPE
Corneal forceps
120 mm

02-3327
MICRO-ADSON
120 mm

02-3328
ADSON
120 mm

02-3329
MICRO-ADSON
150 mm

02-3330 - 02-3332
100 mm

02-3330

02-3331

02-3332

02-3333
BONACCOLTO
110 mm

02-3334
115 mm

02-3335 - 02-3344

02-3335
90 mm

02-3336
105 mm

02-3337
115 mm

02-3338
130 mm

02-3339
145 mm

02-3340
90 mm

02-3341
105 mm

02-3342
115 mm

02-3343
130 mm

02-3344
145 mm

02-3345
100 mm

02-3346
100 mm

02-3347
100 mm

02-3348
KUHNE
Cover glass forceps
105 mm

02-3349
160 mm

Delicate Dissecting Forceps

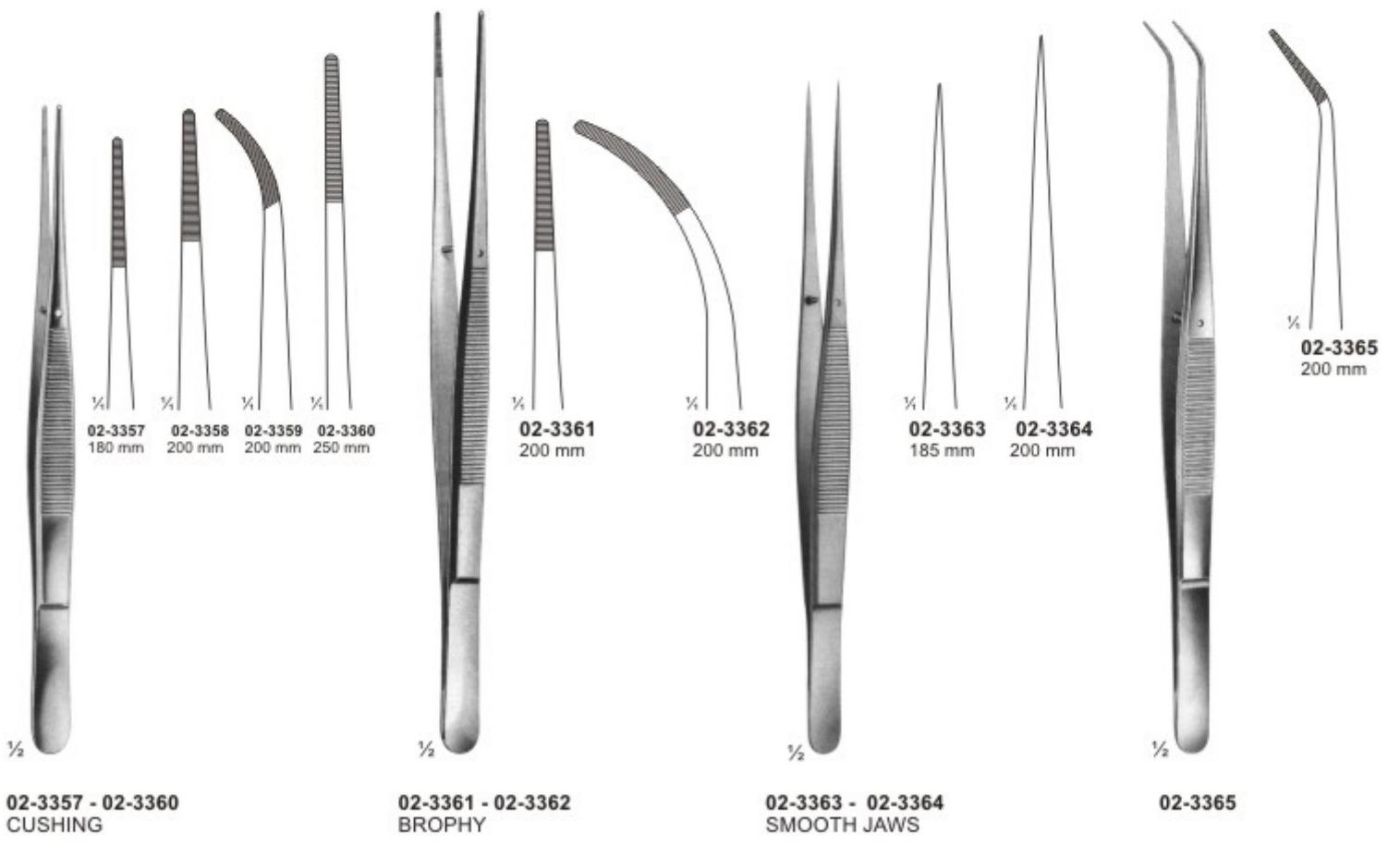
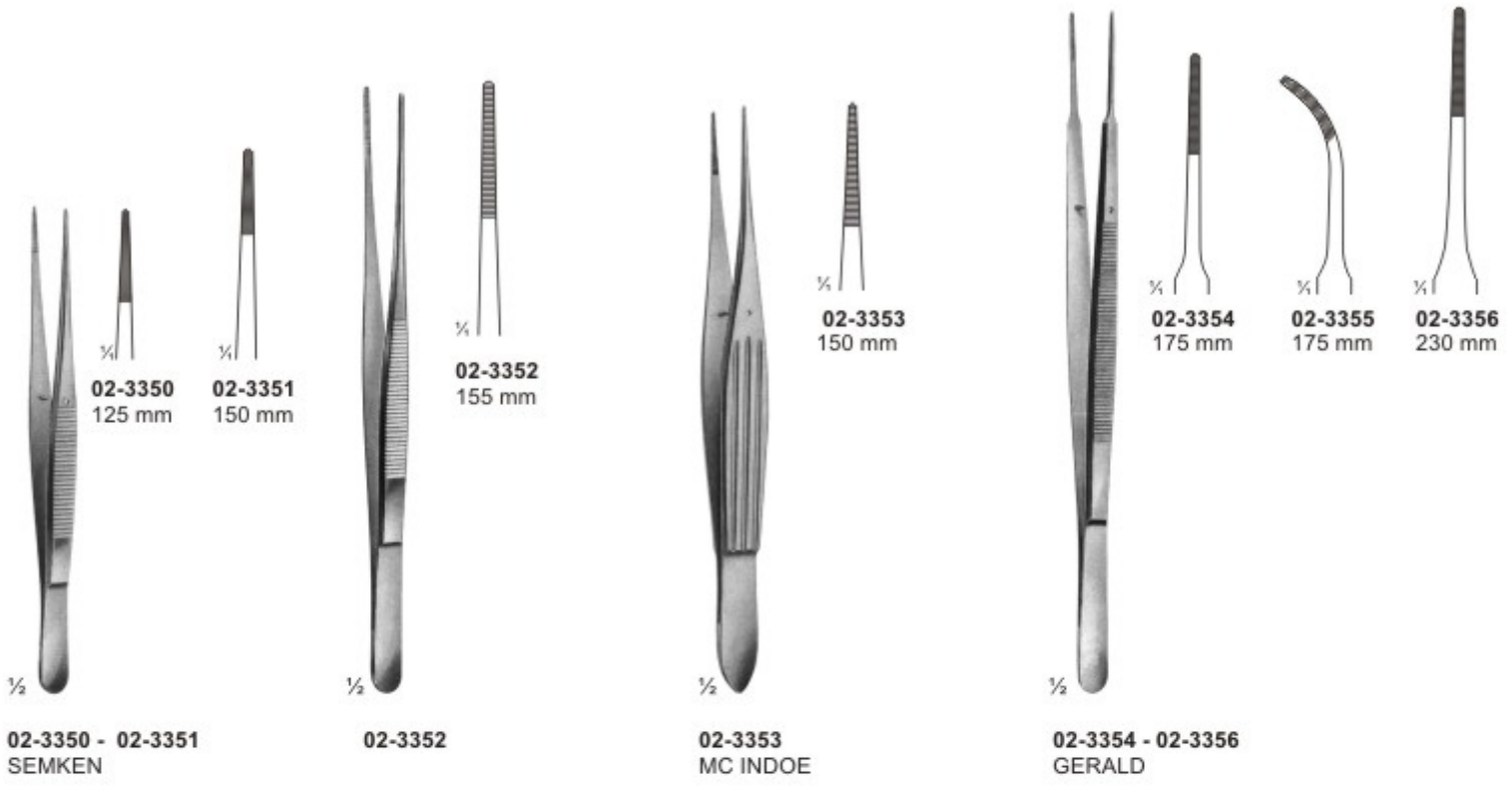

Dissecting Forceps

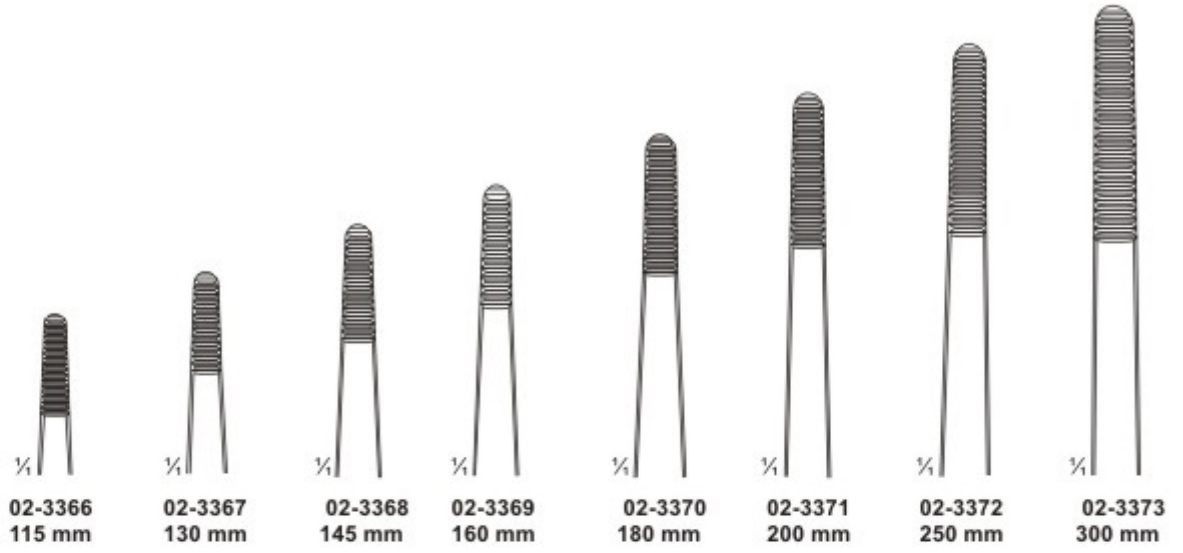

$\frac{1}{4}$	$\frac{1}{4}$	$\frac{1}{4}$	$\frac{1}{4}$	$\frac{1}{4}$	$\frac{1}{4}$	$\frac{1}{4}$	$\frac{1}{4}$	$\frac{1}{4}$
02-3366 115 mm	02-3367 130 mm	02-3368 145 mm	02-3369 160 mm	02-3370 180 mm	02-3371 200 mm	02-3372 250 mm	02-3373 300 mm	

02-3366 - 03-3373
STANDARD



$\frac{1}{4}$	$\frac{1}{4}$	$\frac{1}{4}$	$\frac{1}{4}$	$\frac{1}{4}$
02-3374 115 mm	02-3375 130 mm	02-3376 145 mm	02-3377 160 mm	02-3378 305 mm

02-3374 - 02-3378
MEDIUM



$\frac{1}{4}$	$\frac{1}{4}$
02-3379 130 mm	02-3380 145 mm

02-3379 - 02-3380
MEDIUM

Dissecting Forceps



02-3381
125 mm



02-3382
155 mm



02-3383
130 mm



02-3384
150 mm



02-3385
170 mm



02-3386
200 mm

02-3381 - 02-3382

02-3383 - 02-3386
Swedish pattern



02-3387
OCHSNER
Ligature forceps
145mm



02-3388
FRICKE
Artery forceps
130mm



03-3389
BONNEY
175mm

Ultra-Light Forceps ATRAUMATA

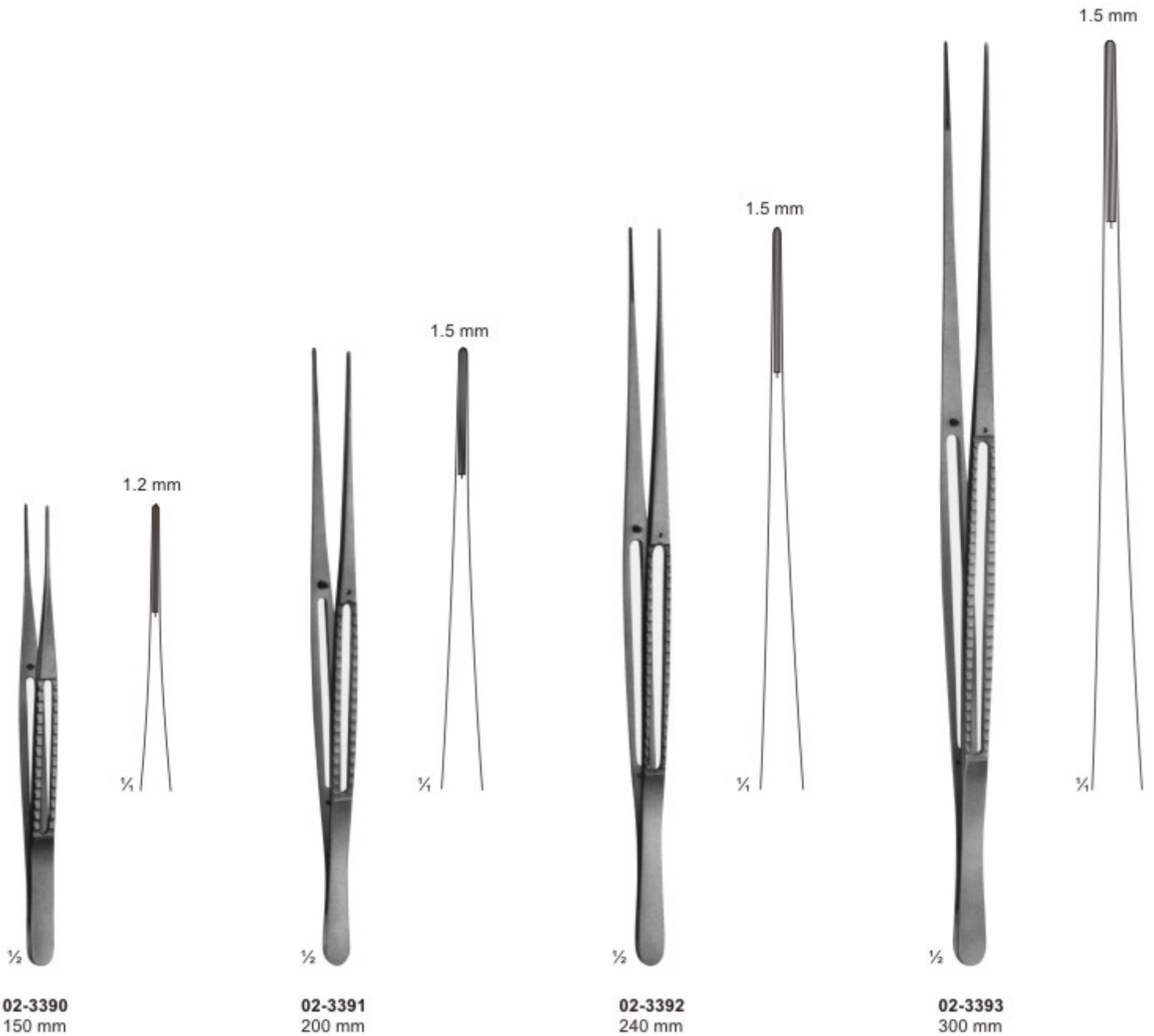

Forceps ATRAUMATA

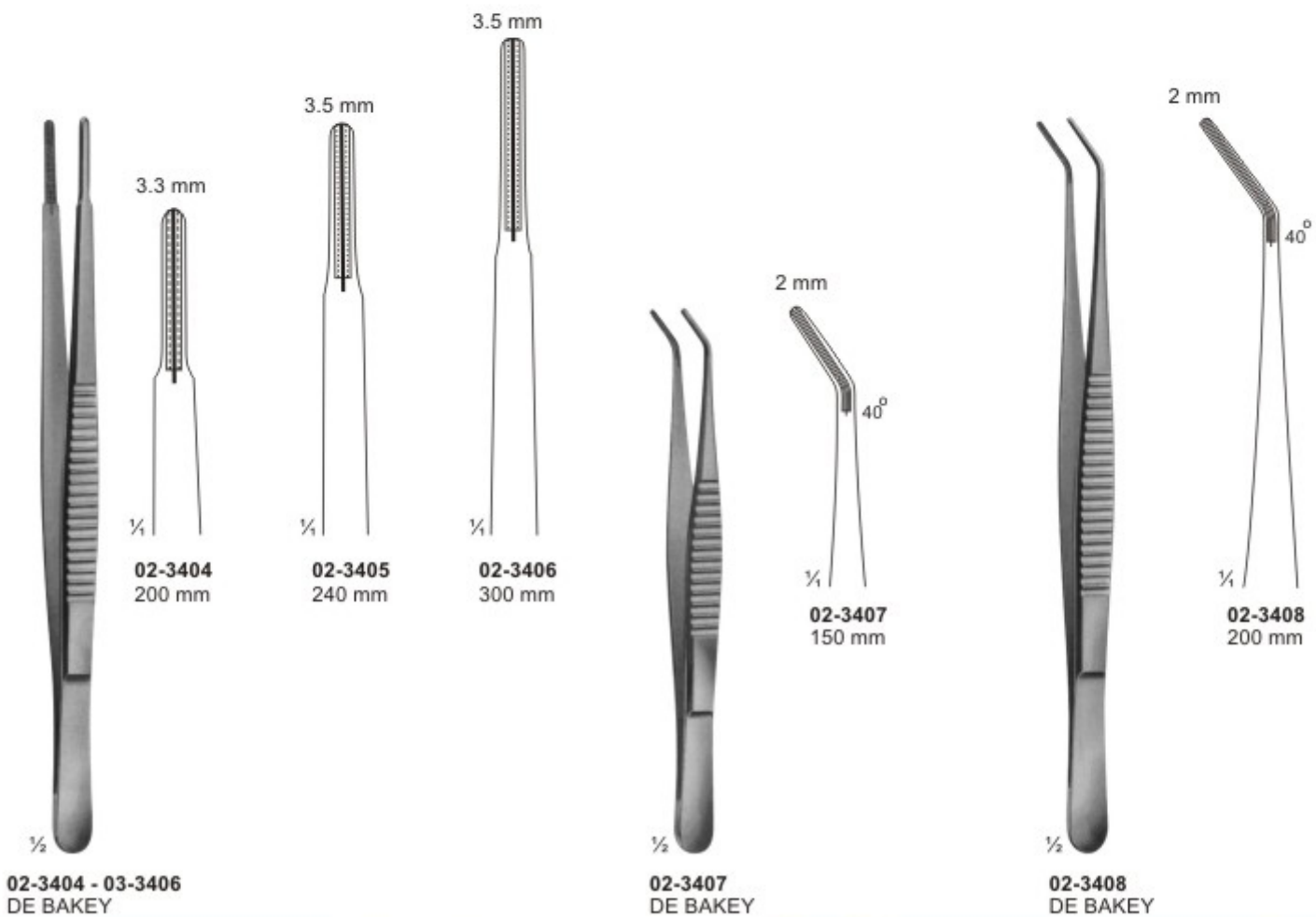
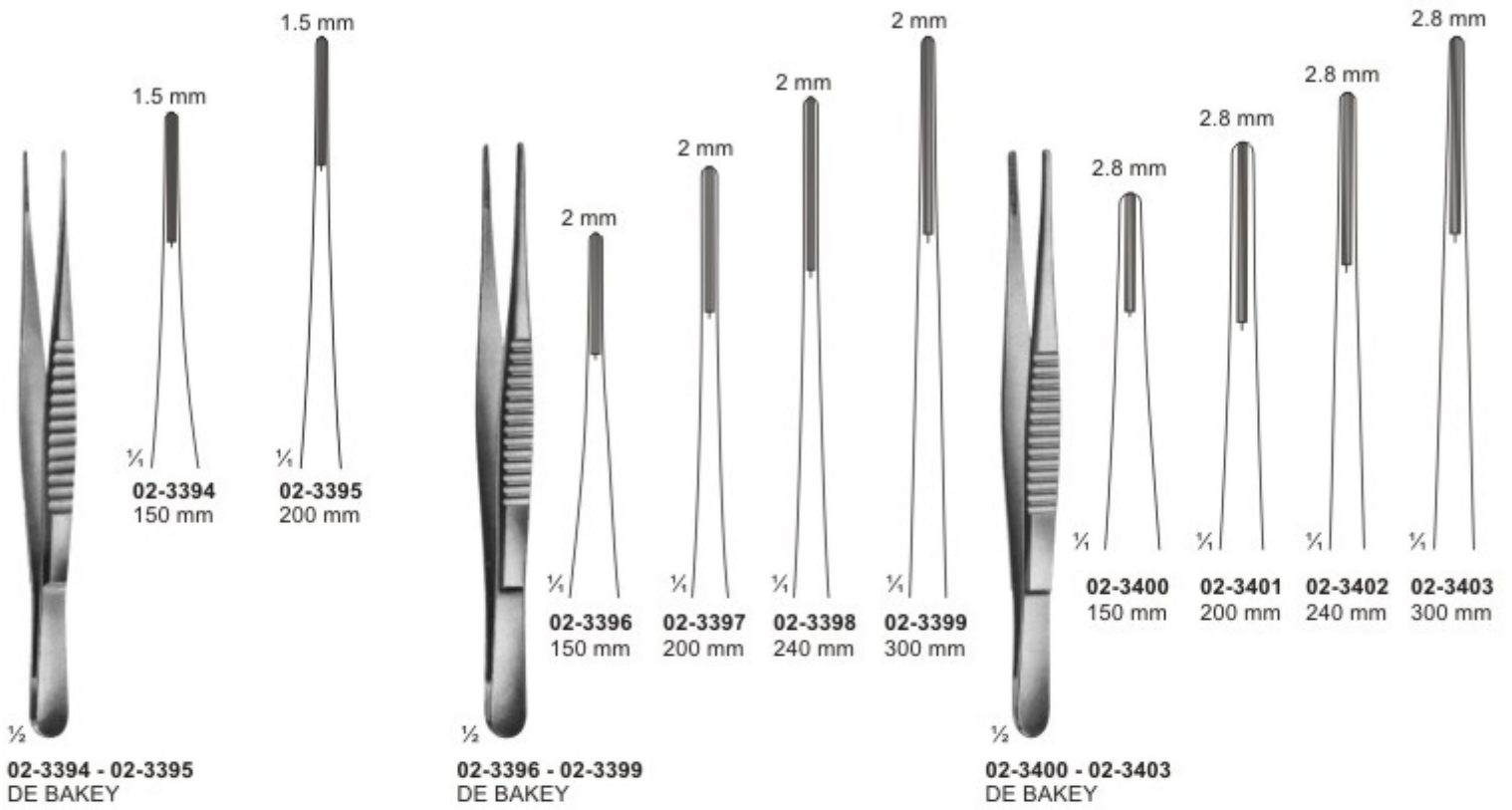

Forceps, Bayonet - Shaped, Angular



02-3409
LUCAE
140 mm

02-3410
LUCAE
1x2 teeth
140 mm

02-3411
COTTLE
Forceps with
jaws toothed
and serrated
140 mm

02-3412
JANSEN
160 mm

02-3413
GRUENWALD
200 mm

02-3414
1x2 teeth
200 mm

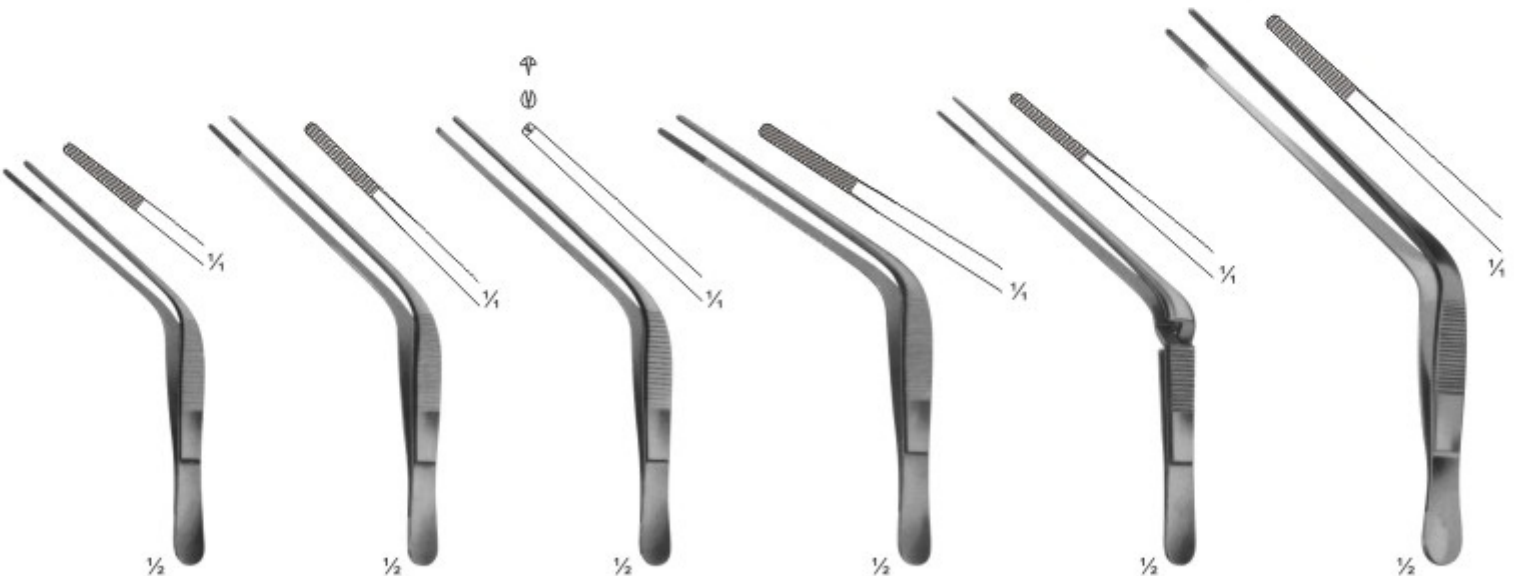

02-3415
TROELTSCH
100 mm

02-3416
TROELTSCH
115 mm

02-3417
TROELTSCH
1X2 teeth
115 mm

02-3418
WILDE
115 mm

02-3419
TROELTSCH
Cross action
120 mm

02-3420
TROELTSCH
140 mm

Delicate Tissue Forceps



02-3421
BISHOP-HARMON
85 mm



02-3422
ST.MARTIN
80 mm

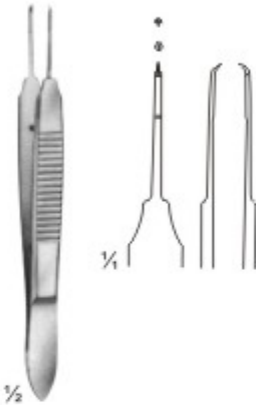

02-3423
CASTROVIEJO
teeth 0.9 mm
100 mm

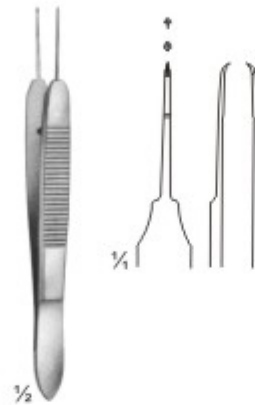

02-3424
CASTROVIEJO
teeth 0.5 mm
100 mm

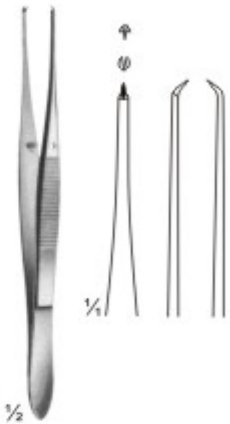

02-3425
ELSCHING
110 mm



02-3426
GILL
75 mm

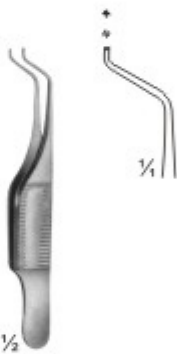

02-3427
GILL - HESS
75 mm

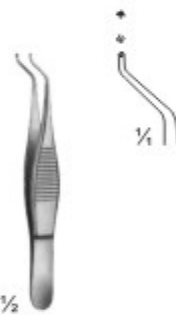

02-3428
HESS
70 mm

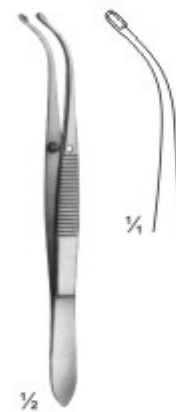

02-3429
ARRUGA
100 mm

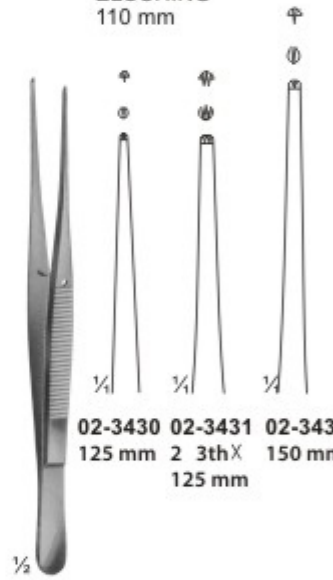

02-3430 02-3431 02-3432
125 mm 2 3thX 150 mm
125 mm

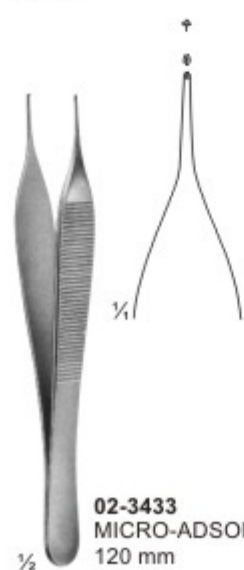

02-3433
MICRO-ADSON
120 mm

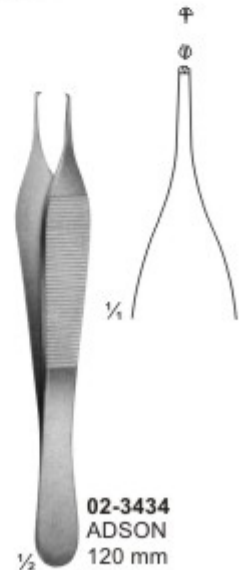

02-3434
ADSON
120 mm

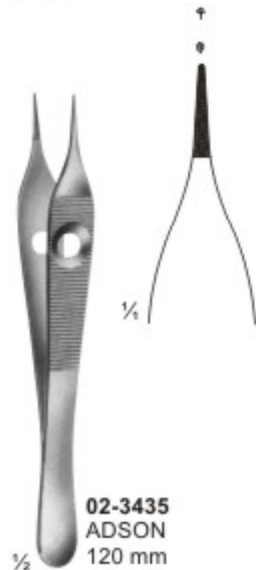

02-3435
ADSON
120 mm

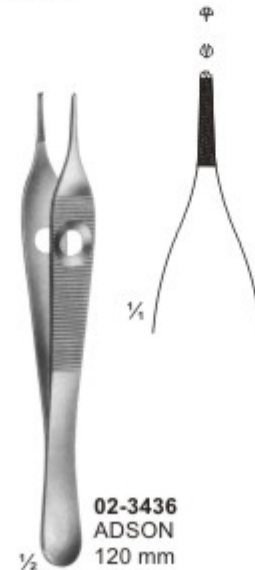

02-3436
ADSON
120 mm

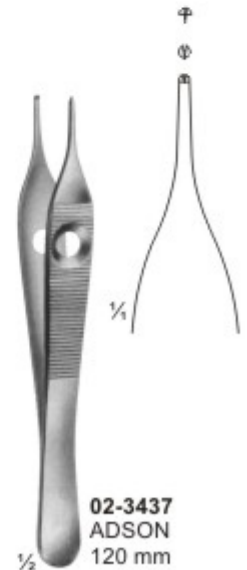

02-3437
ADSON
120 mm

Tissue Forceps

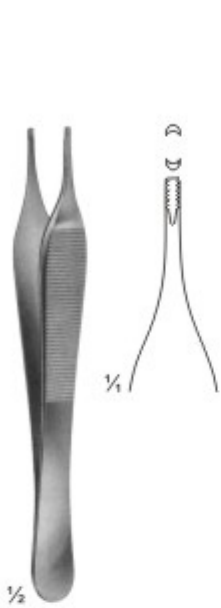

02-3438
ADSON - BROWN
Non-traumatic
120 mm



02-3439
BROWN
150 mm



02-3440
GRAEFE
110 mm

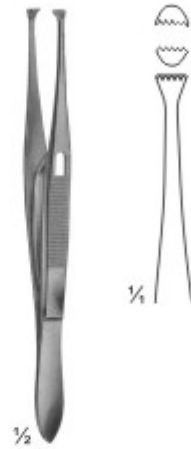

02-3441
GRAEFE
With Catch
110 mm

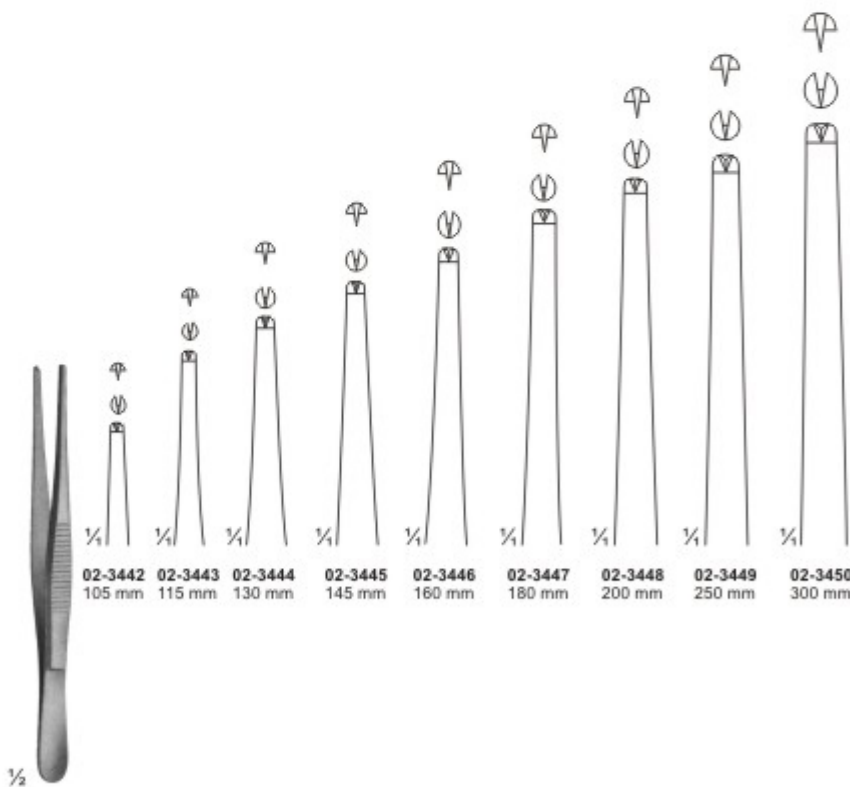

02-3442 - 02-3450
STANDARD

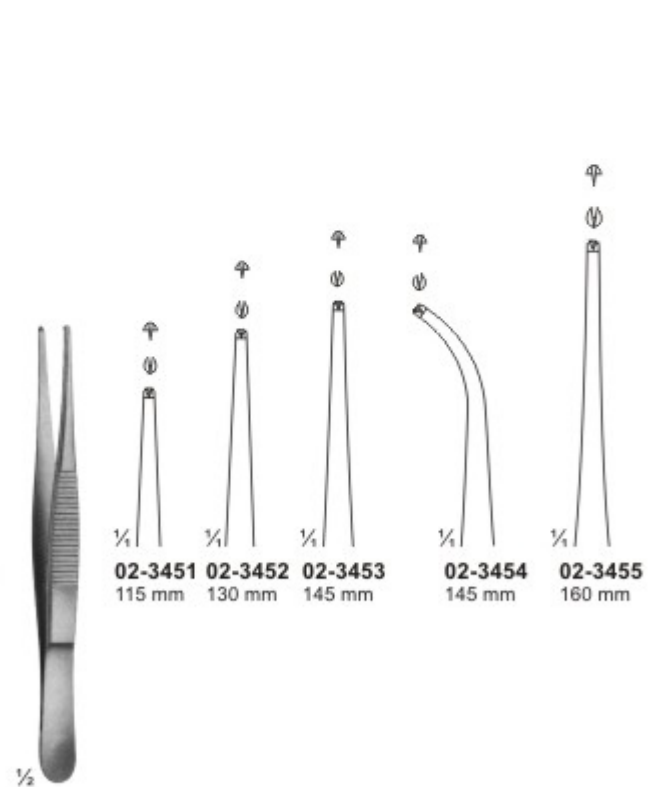

02-3451 - 02-3455
Medium

Tissue Forceps

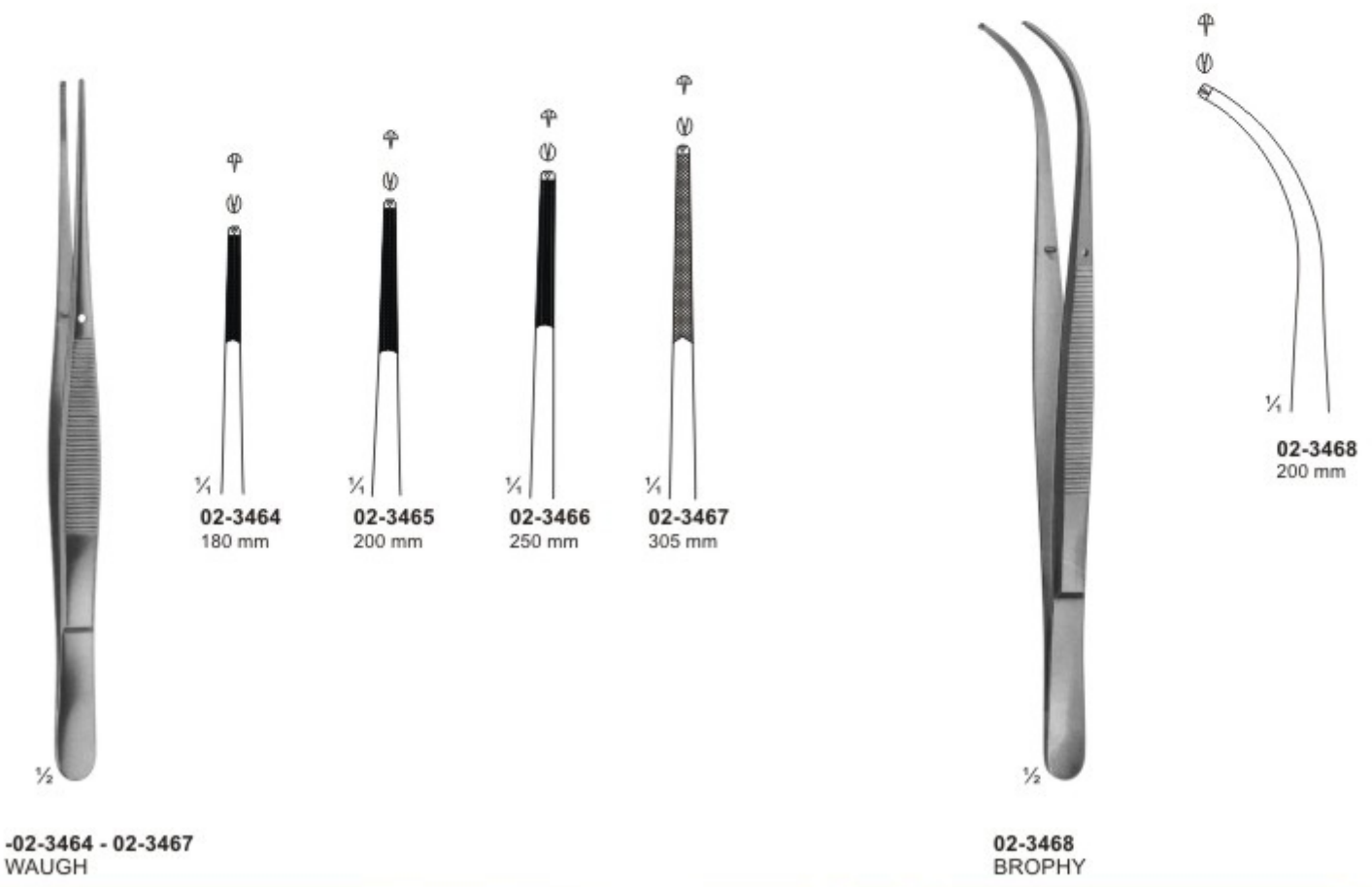
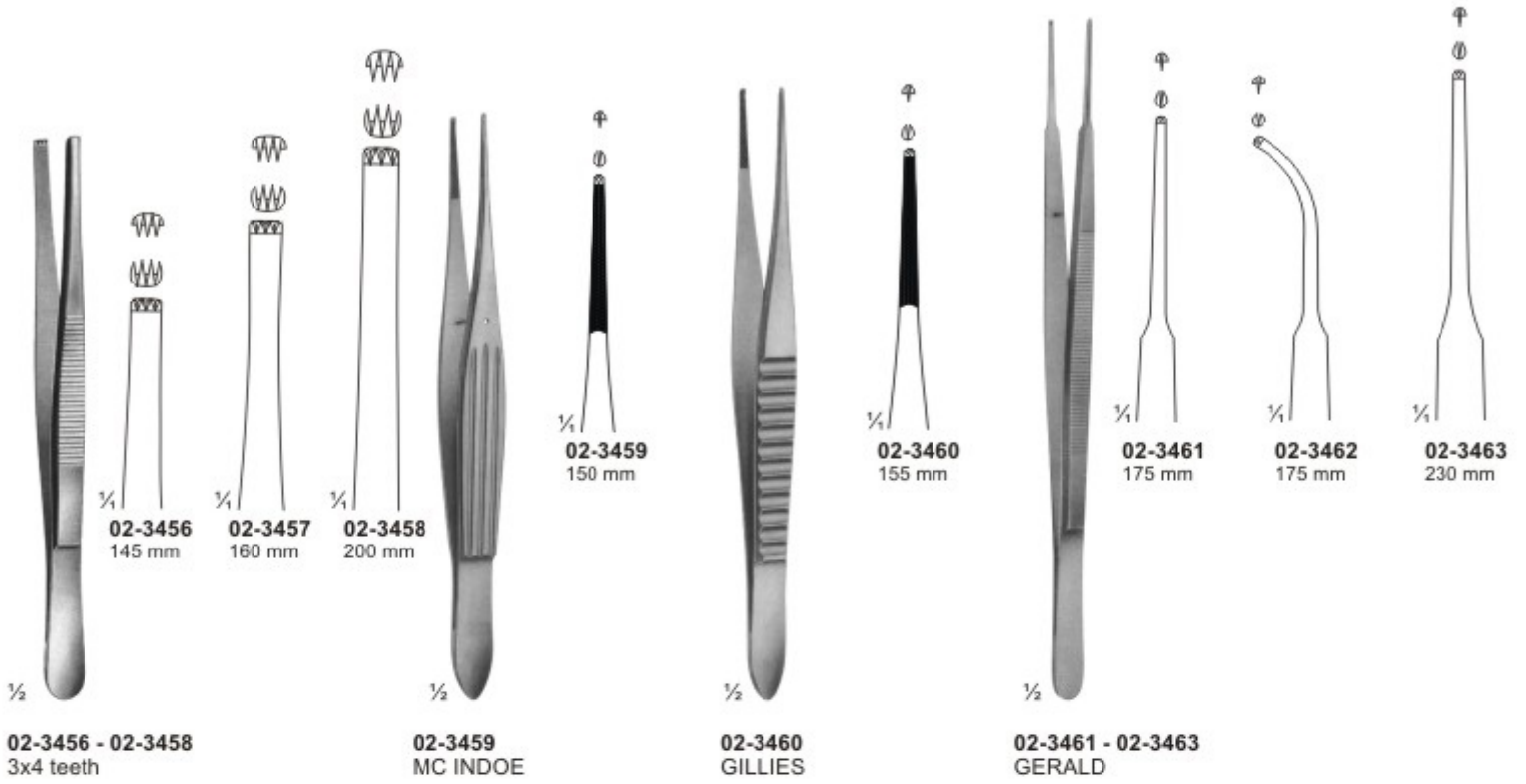

Tissue Forceps, Lung Dissecting Forceps, Intestinal Forceps

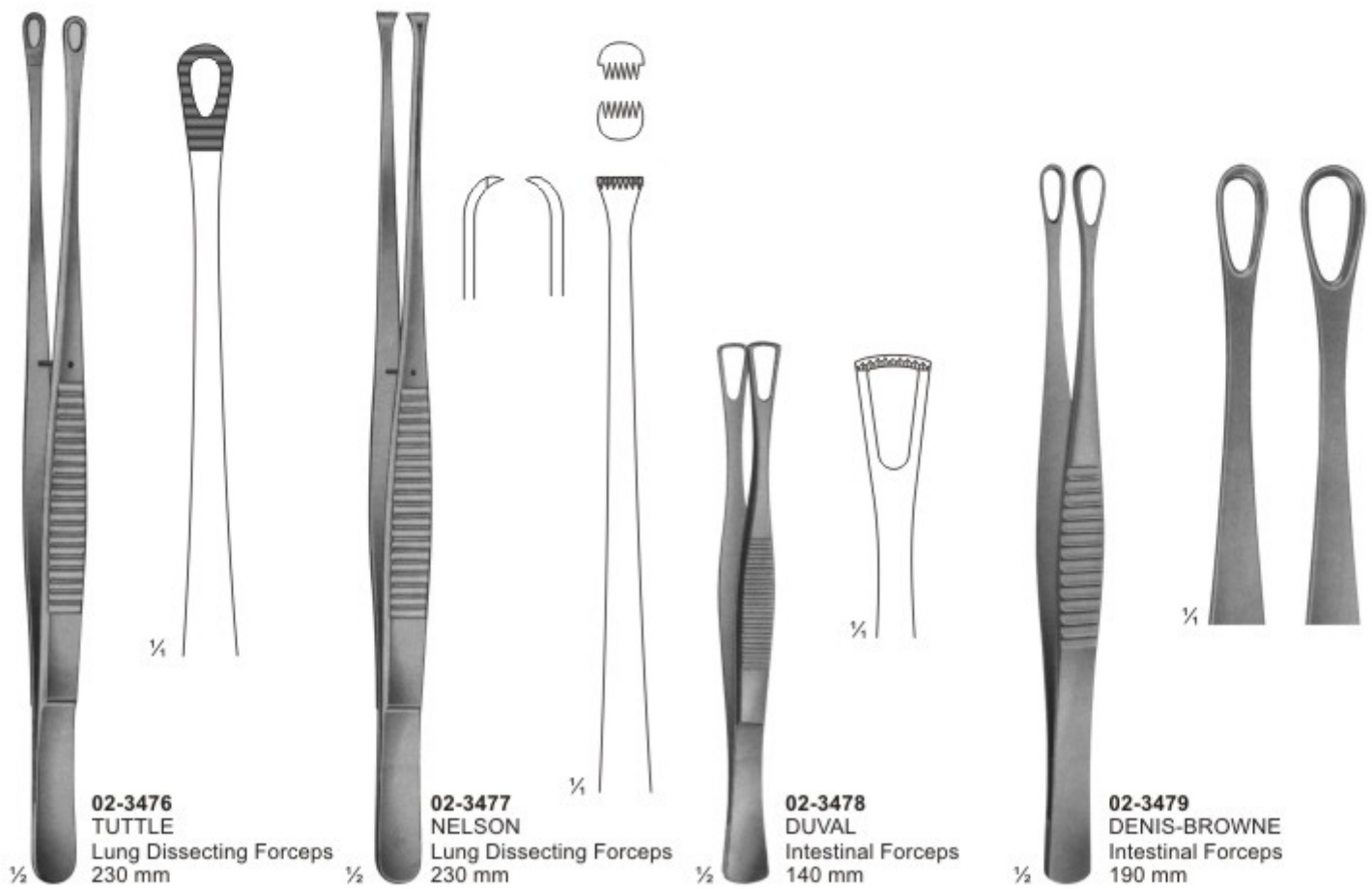
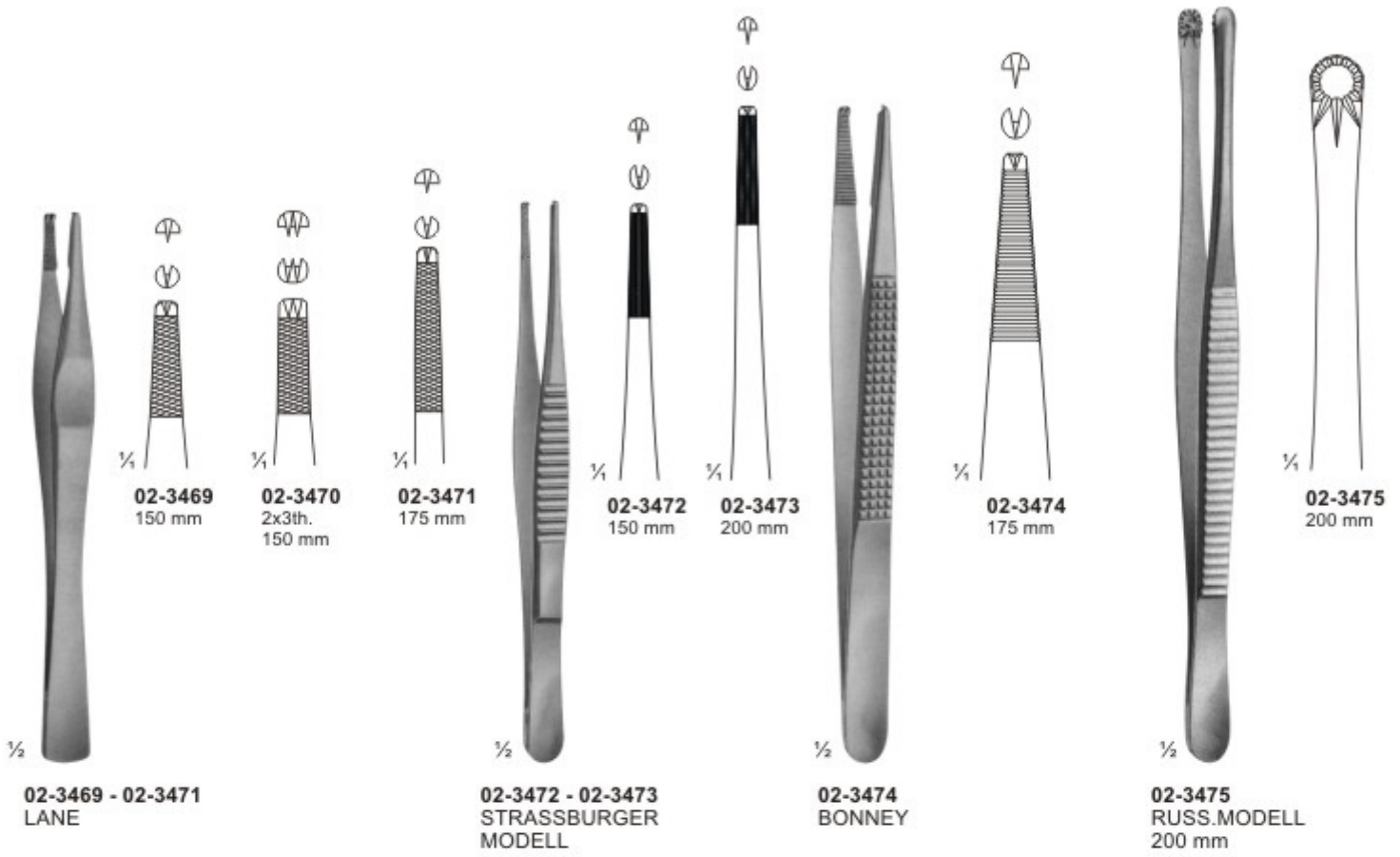

Splinter and Cilia Forceps

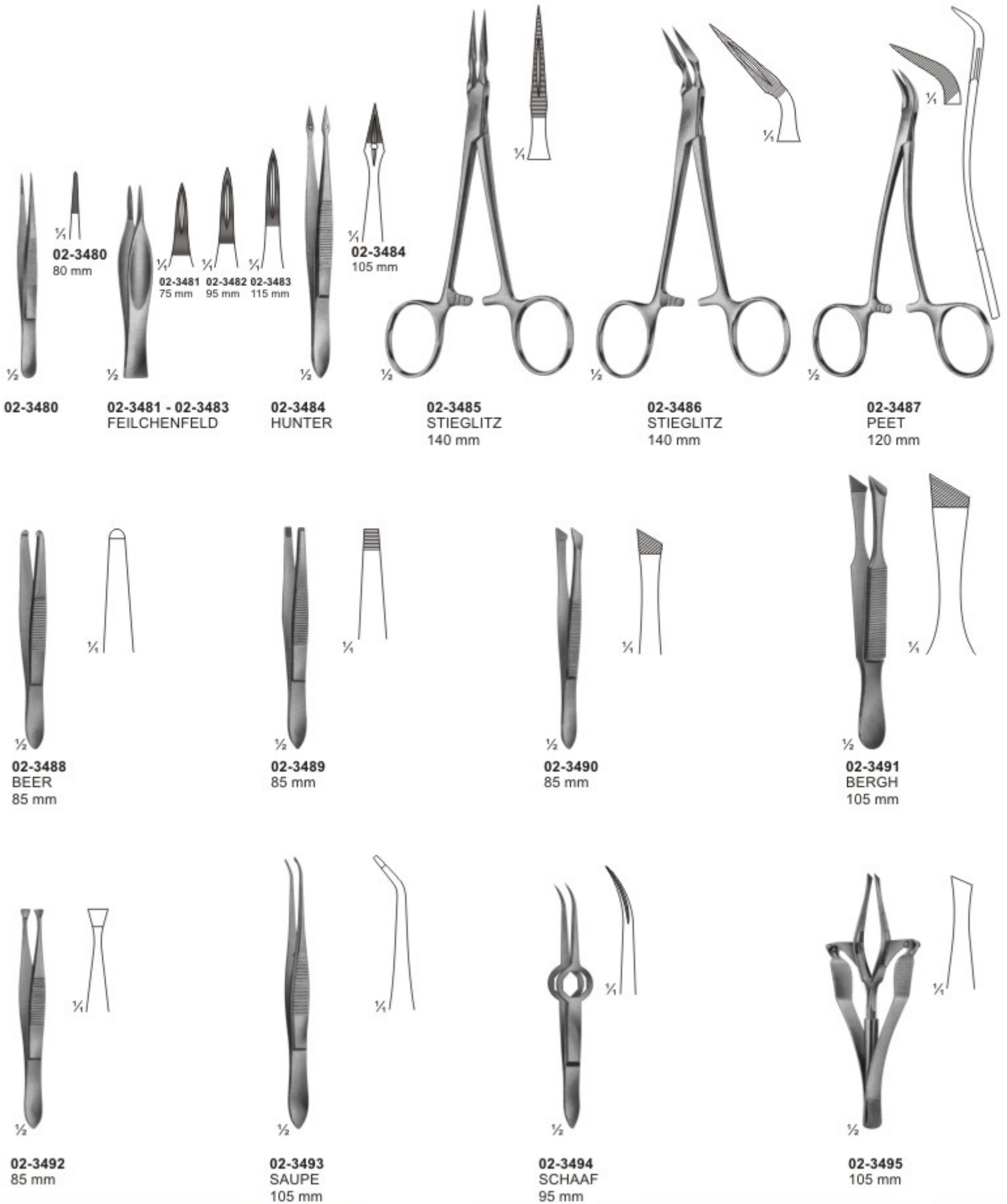

Sponge and Dressing Forceps



02-3496
BRYANT
130 mm



02-3497 - 02-3499
LISTER
Sinus Forceps

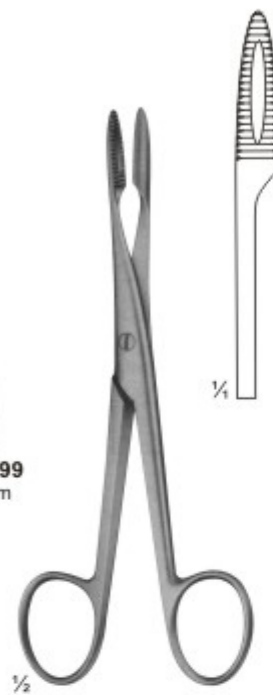

02-3500
Without Ratchet
145 mm

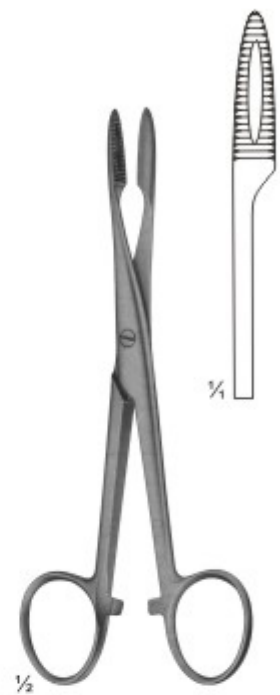

02-3501
With Ratchet
145 mm

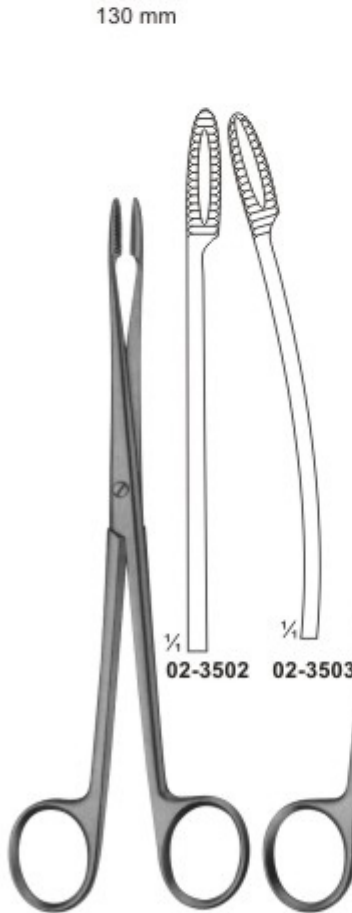

02-3502 - 02-3503
GROSS
Without Ratchet
180 mm

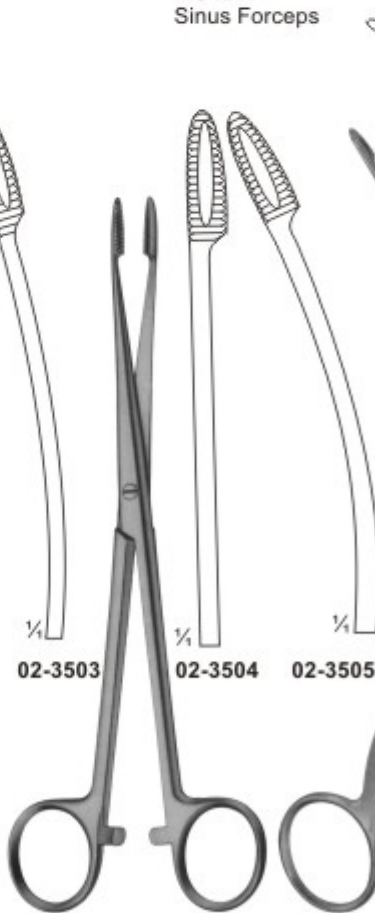

02-3504 - 02-3505
GROSS
With Ratchet
180 mm

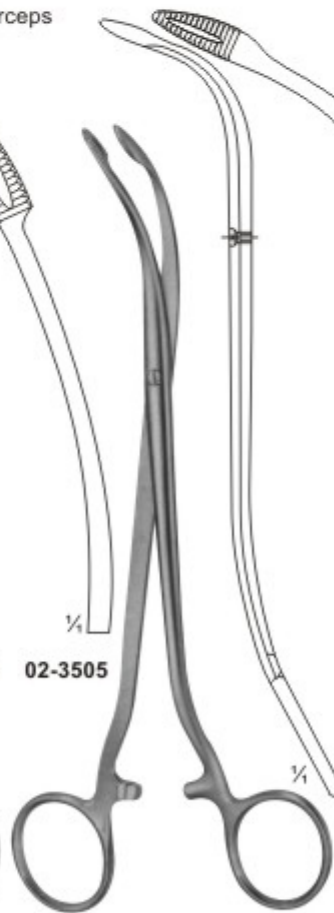

02-3506
DUPLAY
190 mm

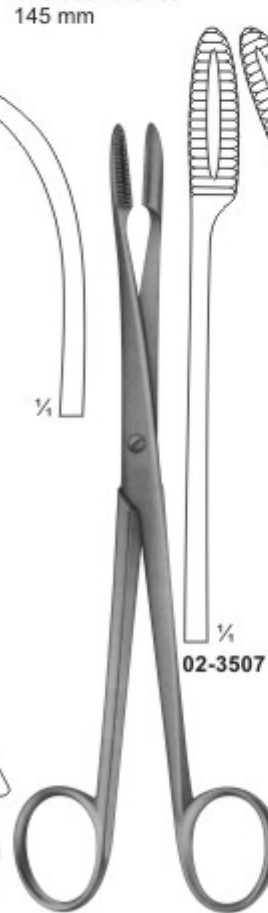

02-3507 - 02-3508
GROSS
Without Ratchet
200 mm

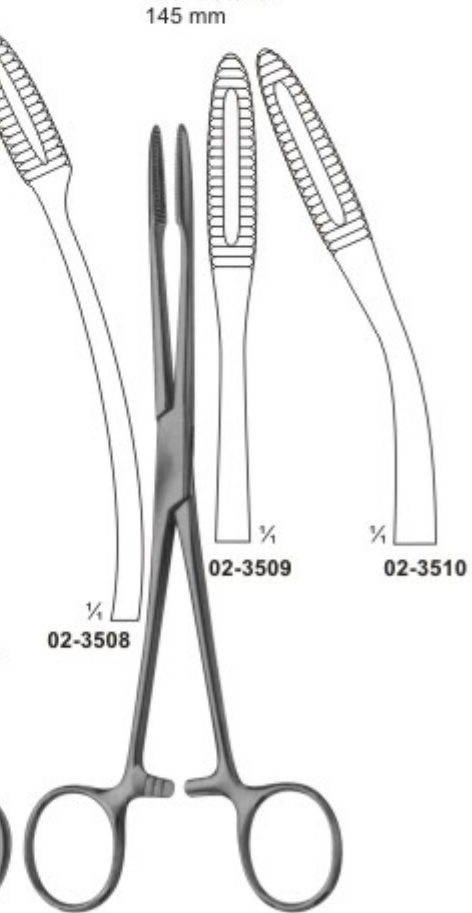

02-3509 - 02-3510
GROSS
With Ratchet
200 mm

Sponge and Dressing Forceps

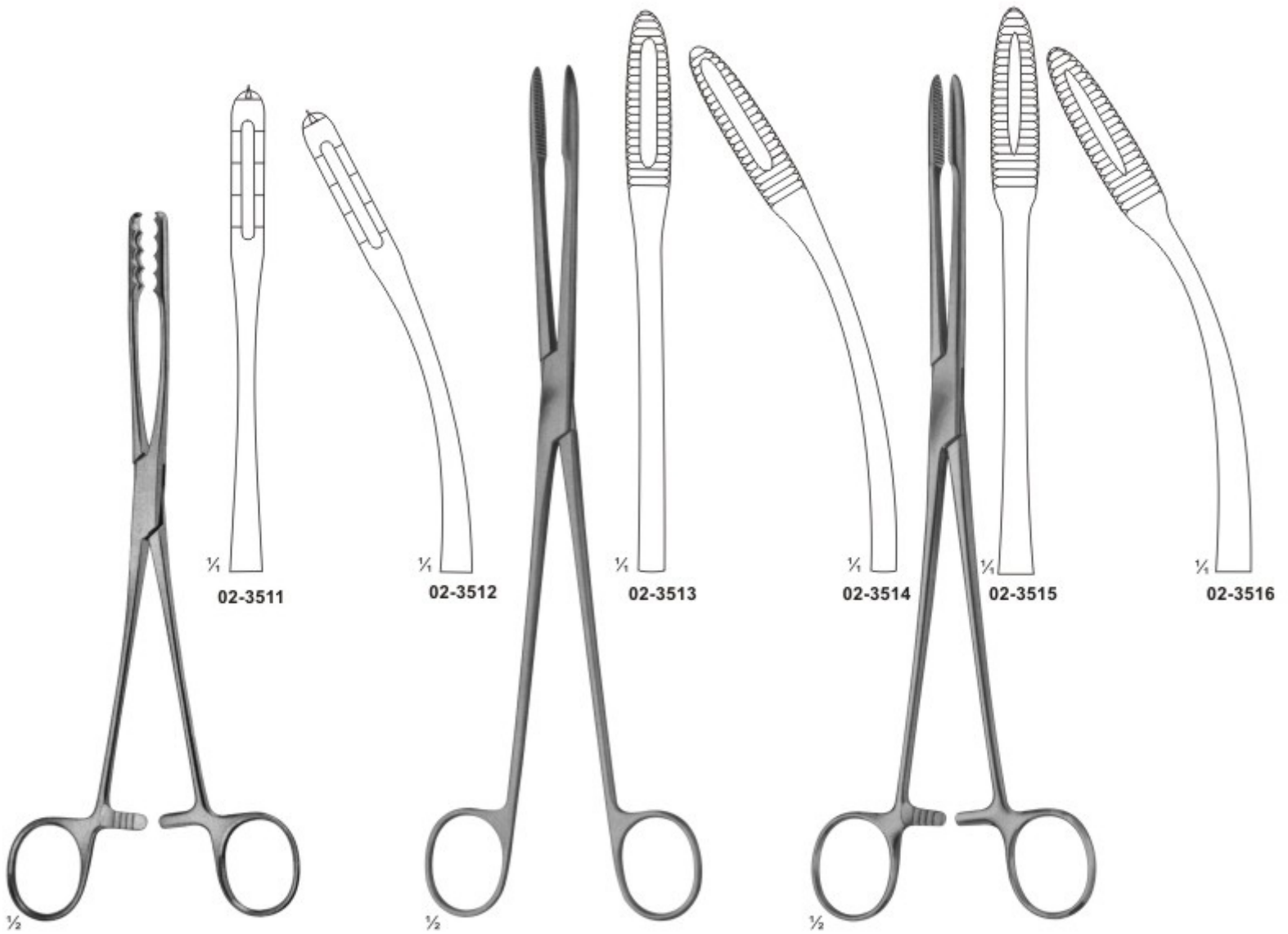

02-3511 - 03-3512
ALM
220 mm

02-3513 - 02-3514
MAIER
Without Ratchet
265 mm

02-3515 - 02-3516
MAIER
With Ratchet
265 mm

Sponge and Dressing Forceps



1/4
02-3517

1/4
02-3518

1/4

1/4

1/4

1/2

1/2

1/2

1/2

02-3517 - 02-3518
SIMS-MAIER
280 mm

02-3519
COLLIN
240 mm

02-3520
CHERON
Handles Laterally Angled
240 mm

02-3521
EMMET
210 mm

Dressing, Sponge Holding, Organ and Tissue Grasping Forceps and Haemostatic Forceps

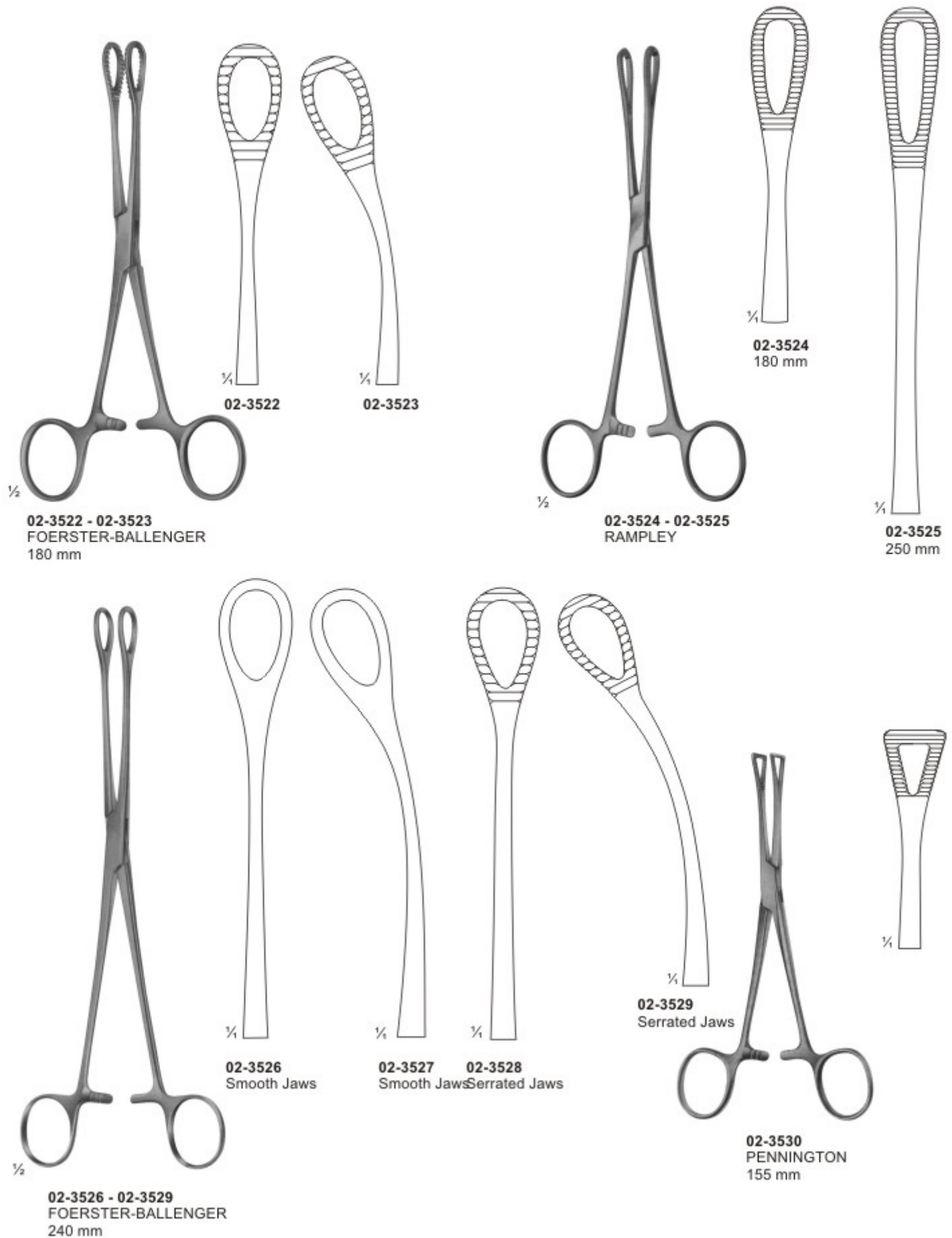

Dressing, Sponge holding, Organ and Tissue Grasping Forceps

ATRAUMATA



02-3531
195 mm



02-3532
230 mm

02-3531 - 02-3532
COLLIN

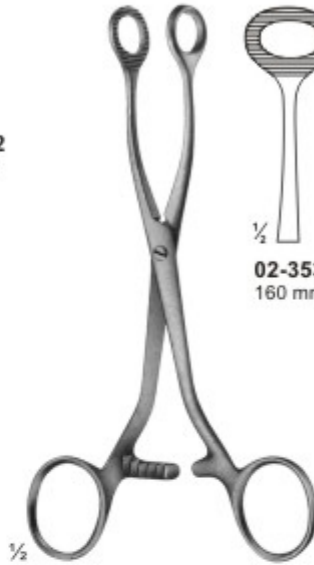

02-3533
160 mm



02-3534
160 mm



02-3535
170 mm

02-3533 - 02-3535
COLLIN

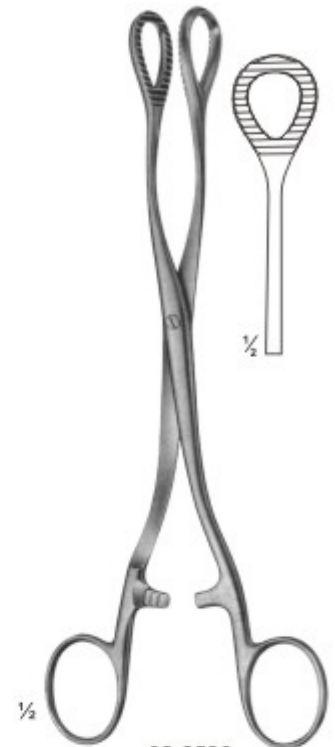

02-3536
HEYWOOD-
SMITH
200 mm

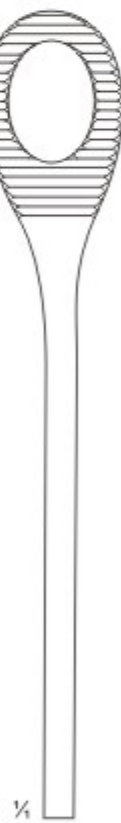

02-3537
NOTO
280 mm

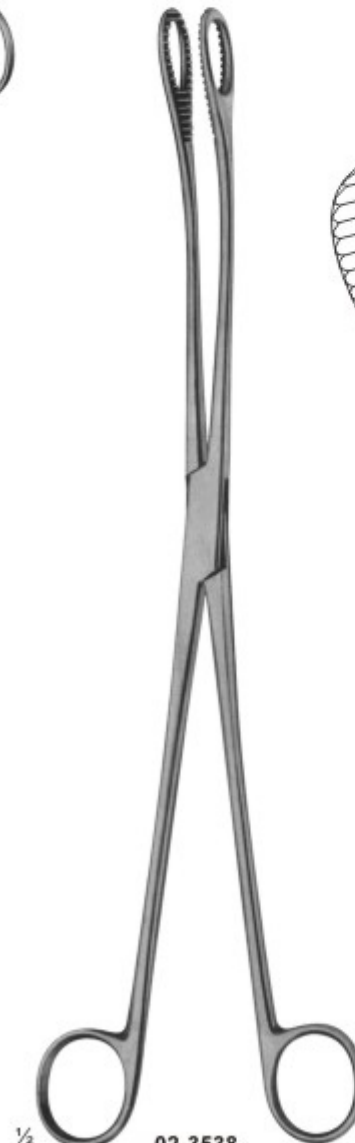

02-3538
KELLY
320 mm

Tendon Seizing Forceps

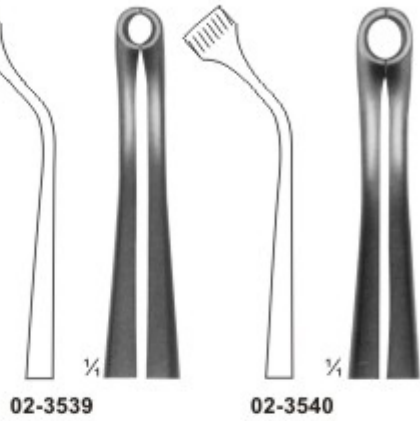

02-3539

02-3540

1/2
02-3539 - 02-3540
HERZ
155 mm



02-3541

1/2
02-3541
JACKSON
4 x 5 teeth
150 mm

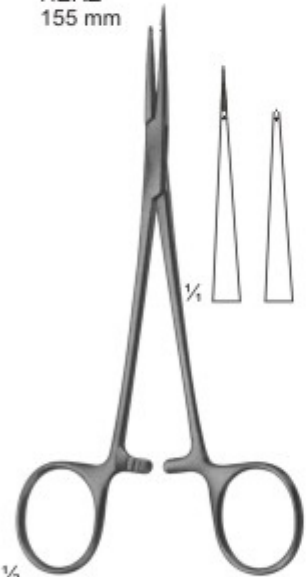

1/2
02-3542
Tendon interlacing
forceps
150 mm



1/2
02-3543
Tendon interlacing
forceps
150 mm

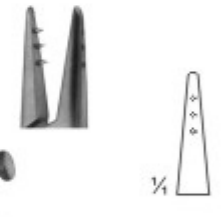

1/2
02-3544
Tendon seizing
forceps
120 mm

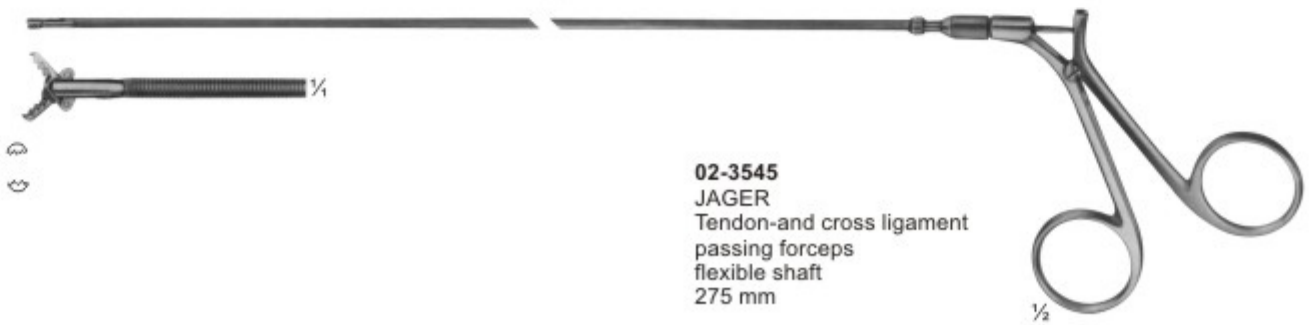

02-3545
JAGER
Tendon and cross ligament
passing forceps
flexible shaft
275 mm

Artery Traction - and Tissue Grasping Forceps

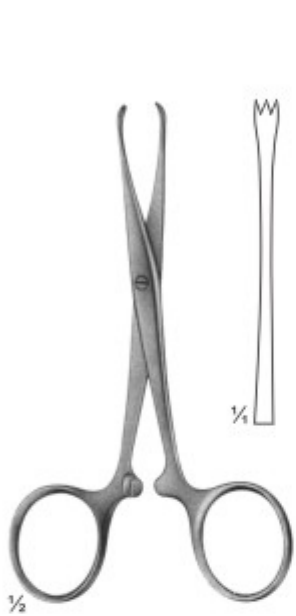

02-3546
CHAPUT
 2 x 3 teeth sharp
 125 mm

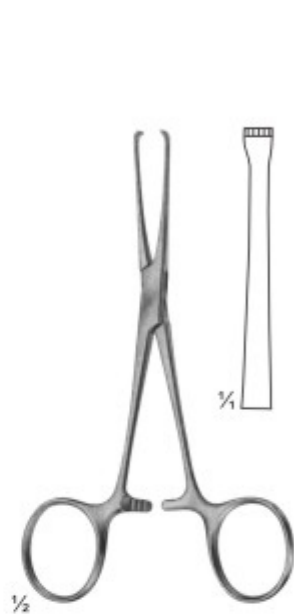

02-3547
BABY-ALLIS
 4 x 5 teeth
 130 mm

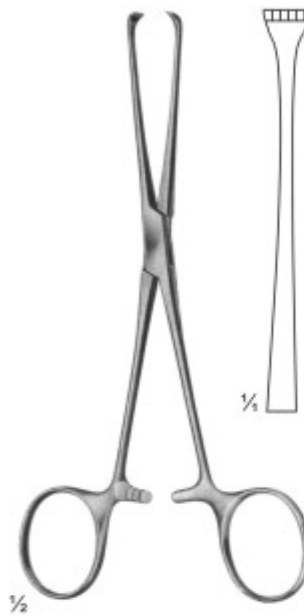

02-3548
BOYS-ALLIS
 5 x 6 teeth sharp
 155 mm

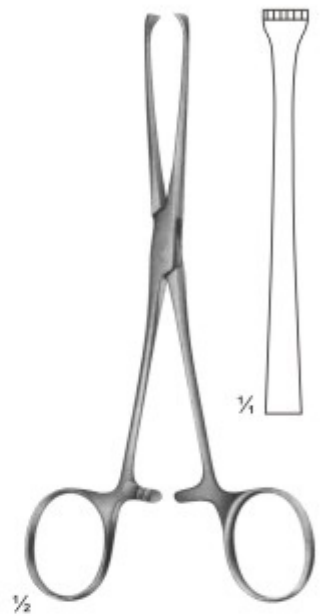

02-3549
ALLIS
 5 x 6 teeth blunt
 155 mm



02-3550
LAHEY
 155 mm

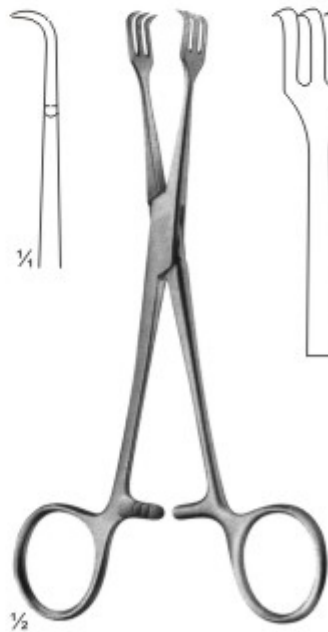

02-3551
LAHEY
 155 mm

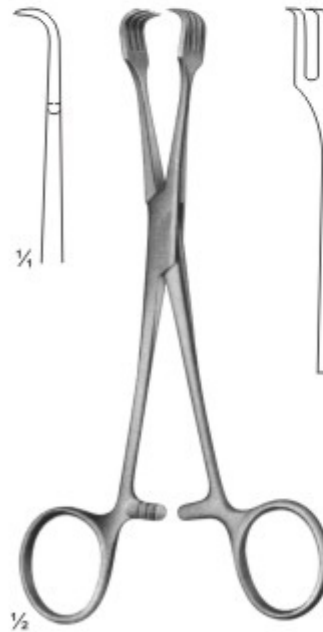

02-3552
BRAUN
 155 mm

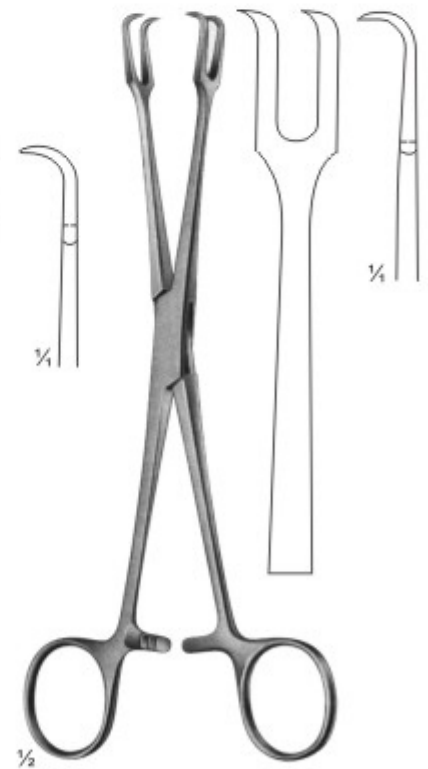

02-3553
MUSEUX
 200 mm

Organ - and Tissue Grasping Forceps

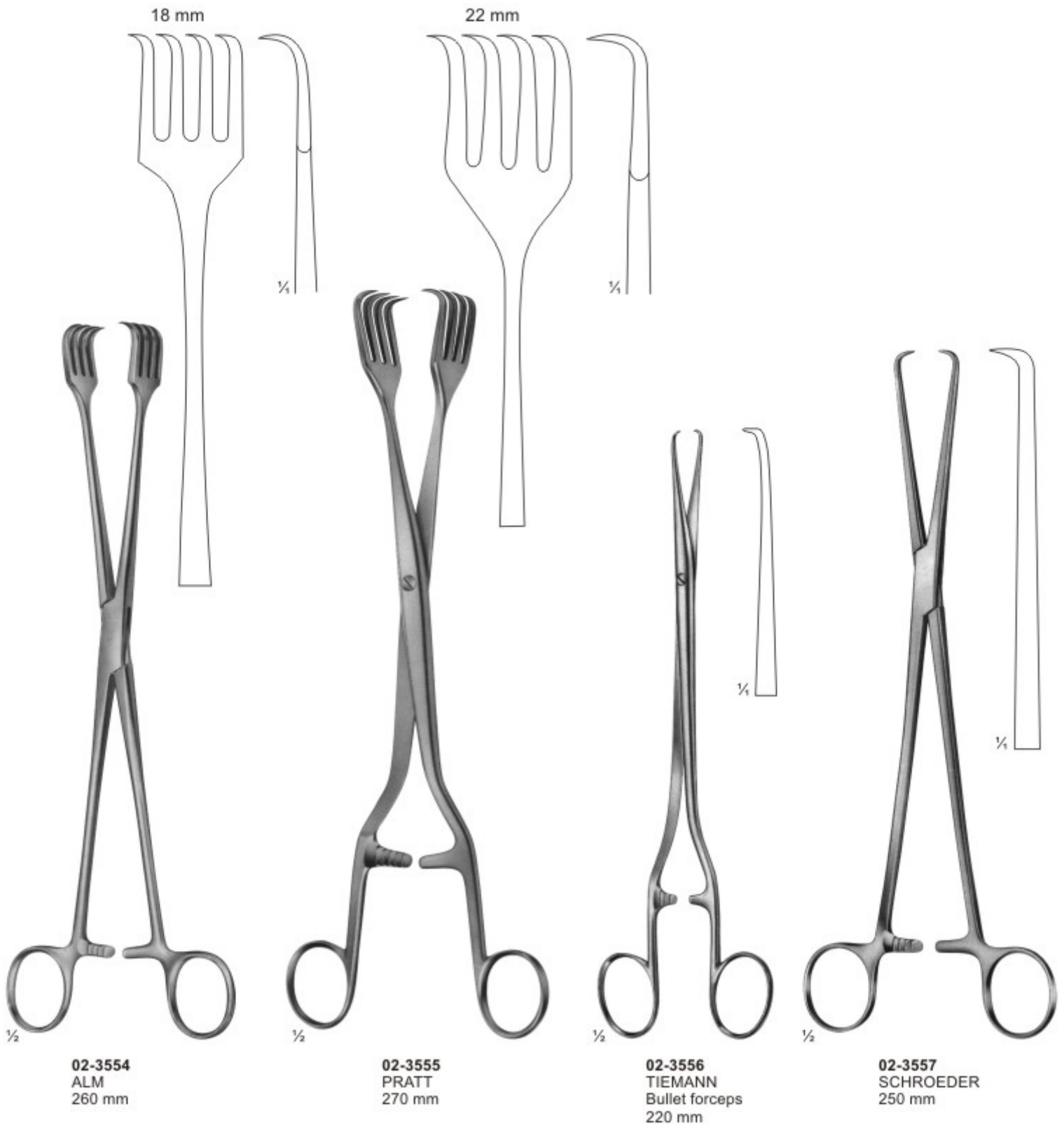

Towel Clamps



02-3558
JONES
85 mm

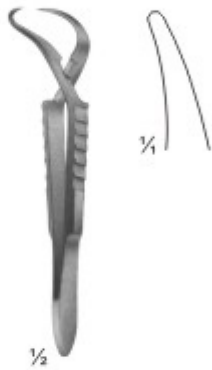

02-3559
ENGL. MOD.
85 mm

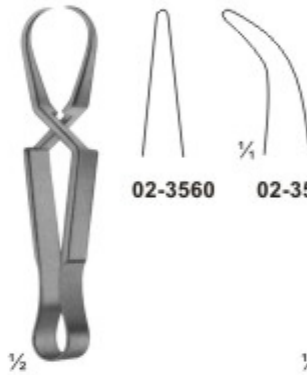

02-3560 - 02-3561
SCHAEFFEL
85 mm



02-3562
DOYEN
110 mm



02-3563
DOYEN
180 mm

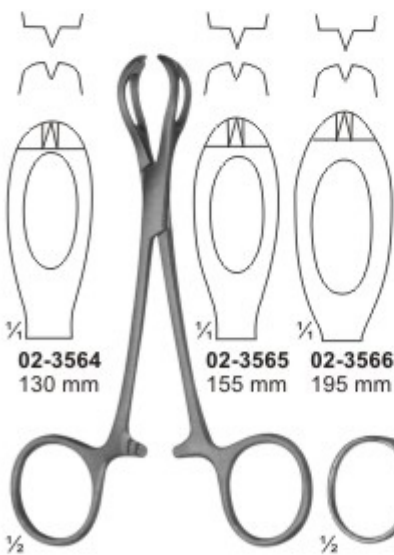

02-3564
130 mm

02-3565
155 mm

02-3566
195 mm

02-3564 - 02-3566
LANE

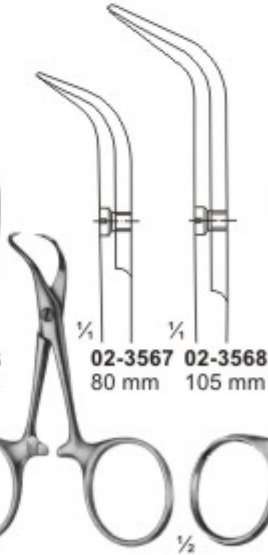

02-3567
80 mm

02-3568
105 mm

02-3567 - 02-3568
BACKHAUS



02-3569
90 mm

02-3570
110 mm

02-3571
135 mm

02-3569 - 02-3571
BACKHAUS



02-3572
BACKHAUS-KOCHER
135 mm

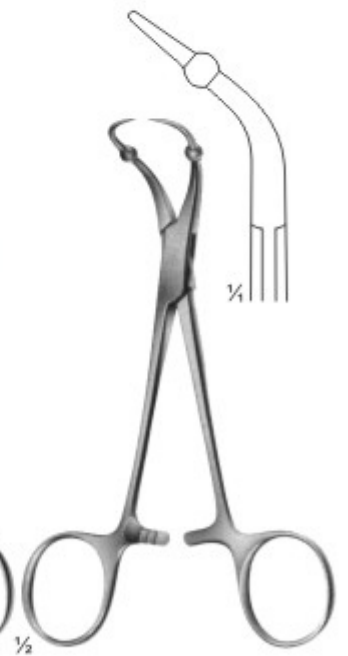

02-3573
ROEDER
135 mm

Towel Clamps and Safety Pins.

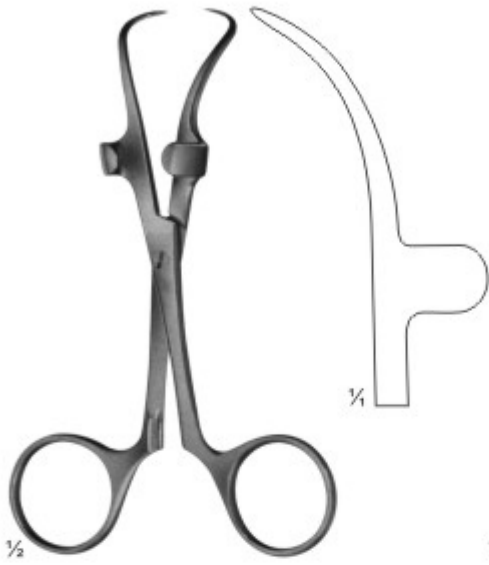

02-3574
ROBIN
 with holders for tubing
 up to 13 mm
 135 mm



02-3575
 with clip for tubing
 up to 15 mm
 110 mm



02-3576
LORNA
 non perforating
 130 mm



02-3577
 for paper cloths
 140 mm



02-3578
BUNT
 105 mm



02-3579
MAYO
 140 mm

Muller Vessel Clips and Bulldog Clamps

Closing force



02-3580
Straight
50g



02-3581
80g



02-3582
Curved
50g



02-3583
80g



02-3584
Curved tips
50g



02-3585
80g



02-3586
Angled
Shaped
50g



02-3587
80g



02-3588
Muller
Knee-bent
50g



02-3589
80g



02-3590
Muller
Ligature Forceps



Jaw, cross
serrated
Jaws profiles
finally cross-
serrated.

Non-traumatic vessel clips, temporary.



DIEFFENBACH

¼

02-3591
38 mm
48 mm



DIEFFENBACH

¼

02-3592
38 mm
48 mm



DIEFFENBACH

¼

02-3593
58 mm



DIEFFENBACH

¼

02-3594
58 mm



JOHNS-HOPKINS

¼

02-3595 - 02-3601

- 02-3595** 38 mm
- 02-3596** 48 mm
- 02-3597** 56 mm
- 02-3598** 63 mm
- 02-3599** 70 mm
- 02-3600** 80 mm
- 02-3601** 91 mm



¼

02-3602
DE BAKEY-
HESS
Length of
Jaws 20 mm

Bulldog Clamps



02-3603
35 mm



02-3604
35 mm



02-3605
45 mm



02-3606
45 mm



DE BAKEY

02-3607
Length
50 mm
Jaws
27 mm



DE BAKEY

02-3608
Length
48 mm
Jaws
27 mm



75°

02-3609
GLOVER
Length
57 mm
Jaws 35 mm



02-3610
DE BAKEY
Length 73 mm
Jaws 38 mm



02-3611
DE BAKEY
Length 99 mm
Jaws 63 mm



02-3612
DE BAKEY
Length 95 mm
Jaws 54 mm



DE BAKEY

	Total length	Length of jaw
02-3613	80mm	25mm
02-3614	90mm	35mm
02-3615	105mm	50mm
02-3616	124mm	68mm



DE BAKEY

	Total length	Length of jaw
02-3617	78mm	25mm
02-3618	86mm	35mm
02-3619	97mm	50mm
02-3620	114mm	68mm



GLOVER

	Total length	Length of jaw
02-3621	68mm	33mm
02-3622	96mm	50mm
02-3623	117mm	69mm



GLOVER

	Total length	Length of jaw
02-3624	65mm	33mm
02-3625	91mm	50mm
02-3626	110mm	69mm

Delicate Haemostatic Forceps



02-3627
CARREL
85 mm



02-3628 - 02-3631
BABY-MOSQUITO
(HARTMANN)
100 mm



02-3632 - 02-3635
MICRO-HALSTED
125 mm



02-3636 - 02-3639
HALSTED-MOSQUITO
125 mm



02-3640 - 02-3641
PROVIDENCE-HOSPITAL
140 mm



02-3642 - 02-3643
KELLY
140 mm

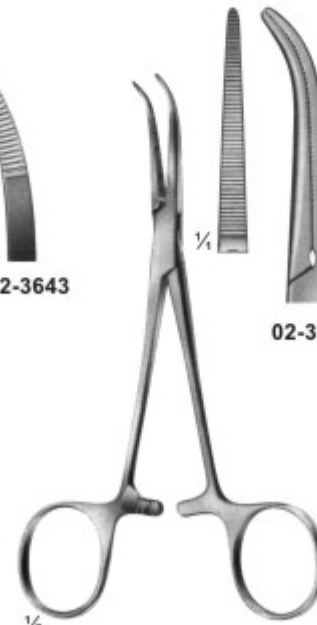

02-3644 - 02-3645
DANDY
Curved sideways
140 mm

Delicate Haemostatic Forceps

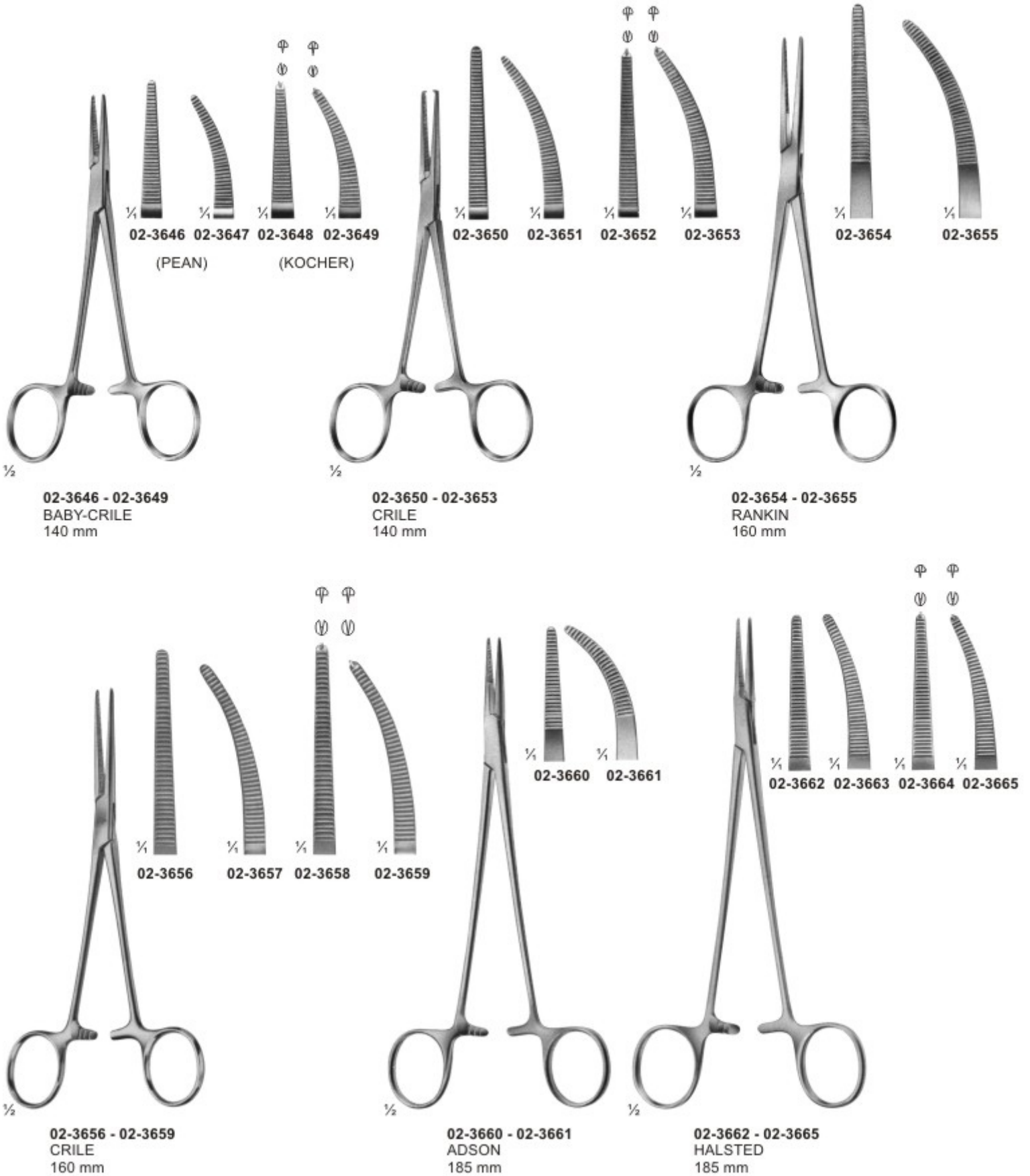

Delicate Haemostatic Forceps

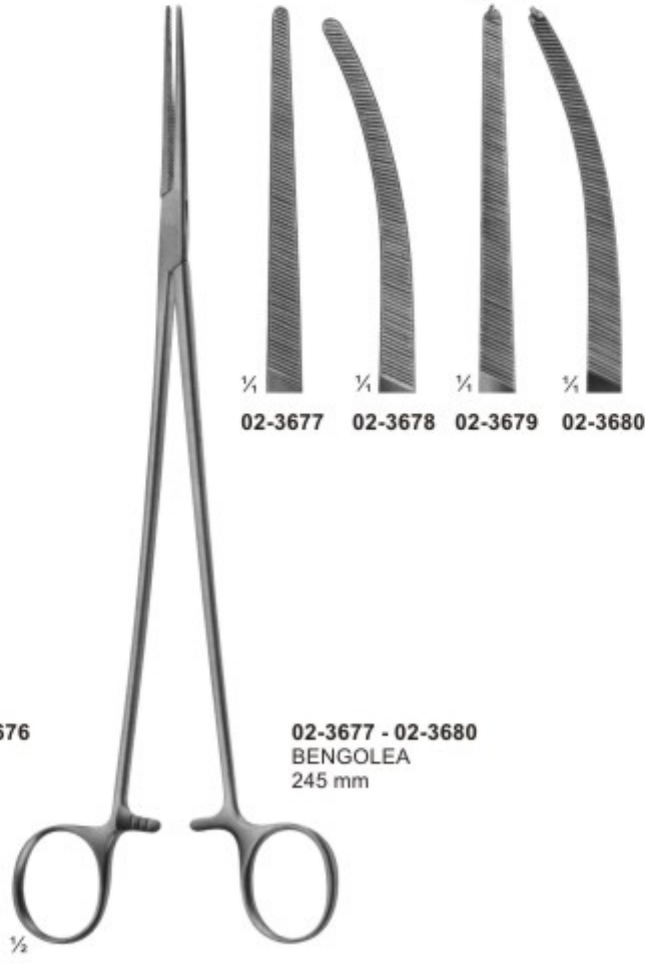
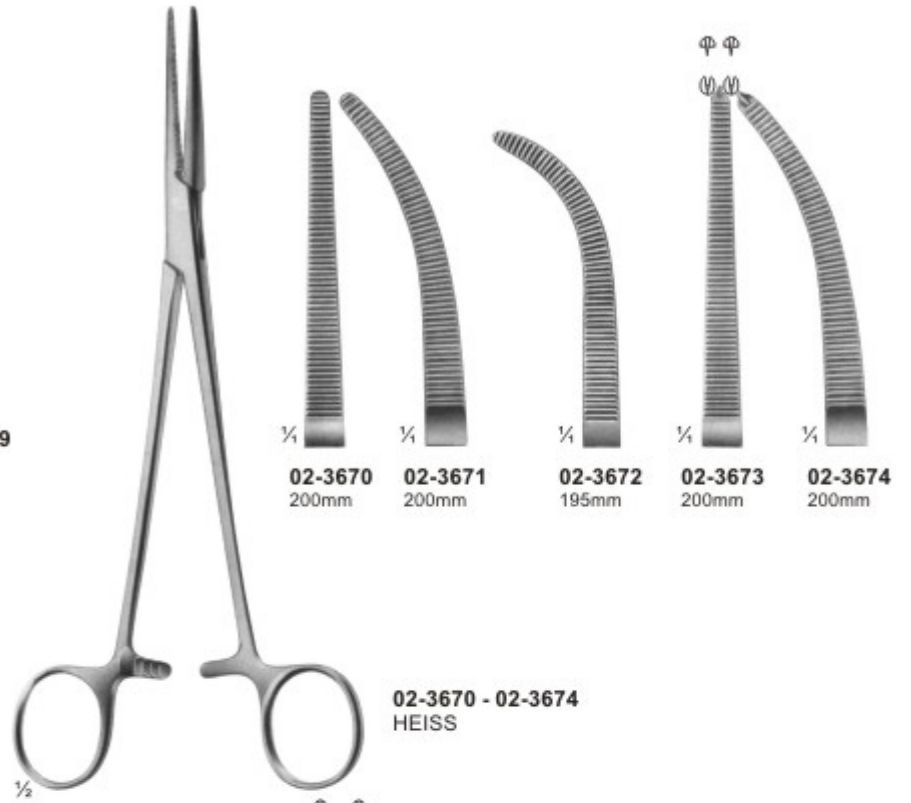
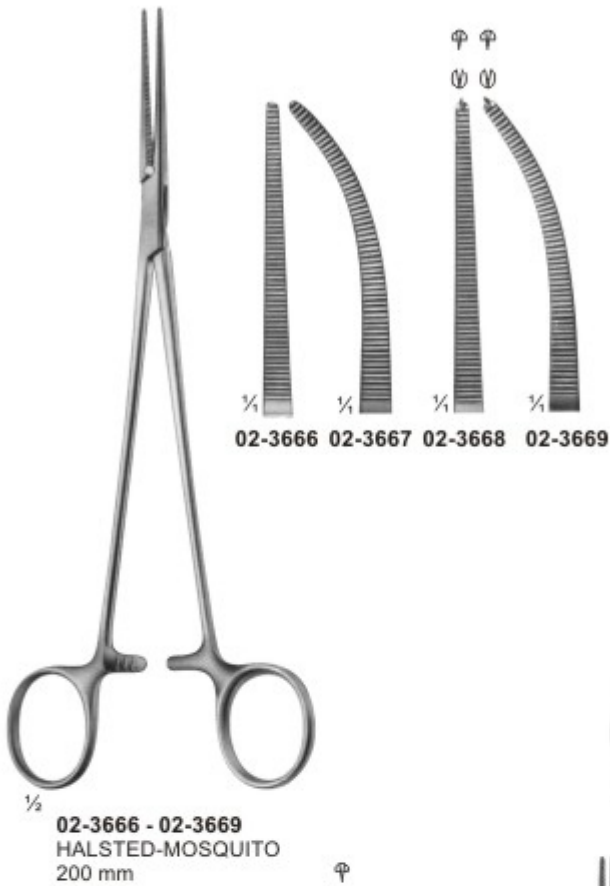

Haemostatic Forceps

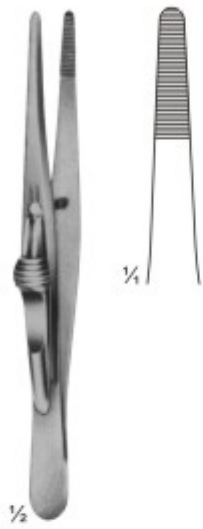

02-3682
FRICKE
Artery forceps
130 mm

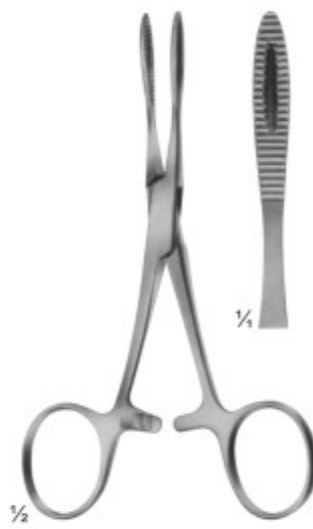

02-3683
KRONLEIN
130 mm

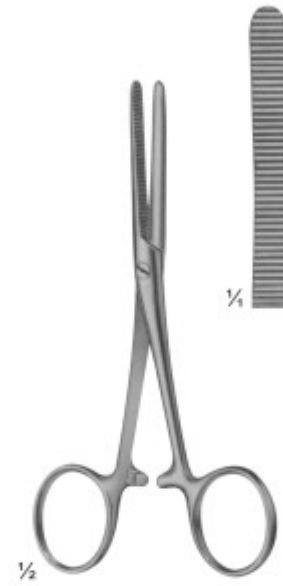

02-3684
PEAN
125 mm



02-3685 - 02-3686
PEAN

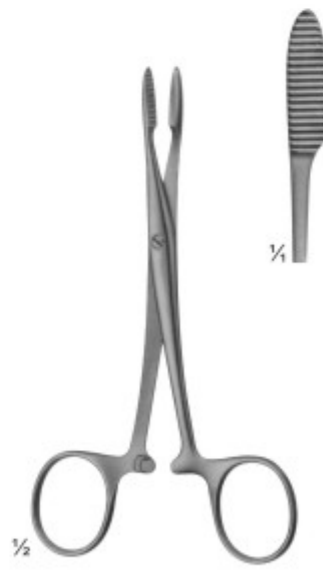

02-3687
PEAN
125mm



02-3688 - 02-3689
PEAN



Haemostatic Forceps

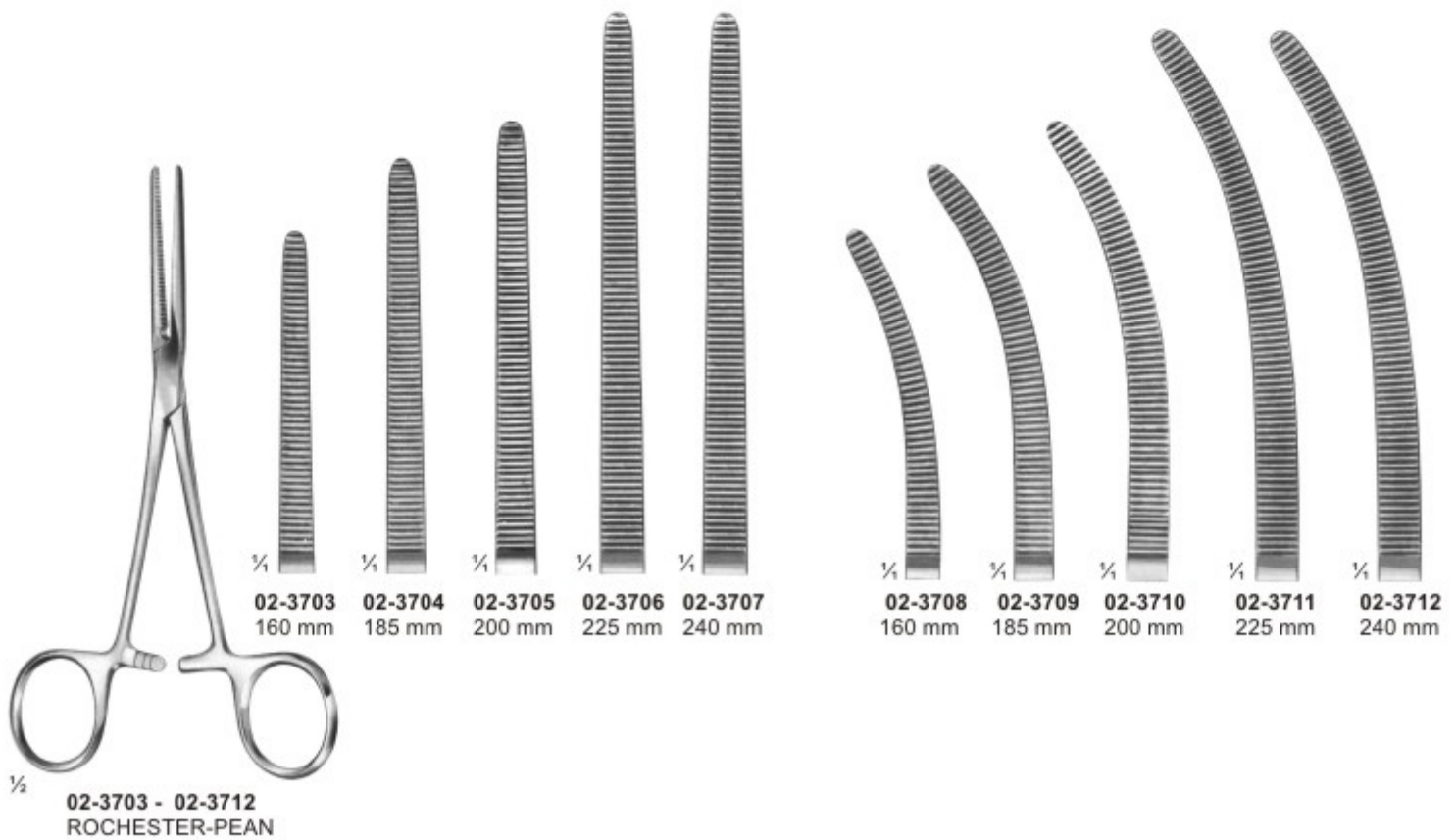
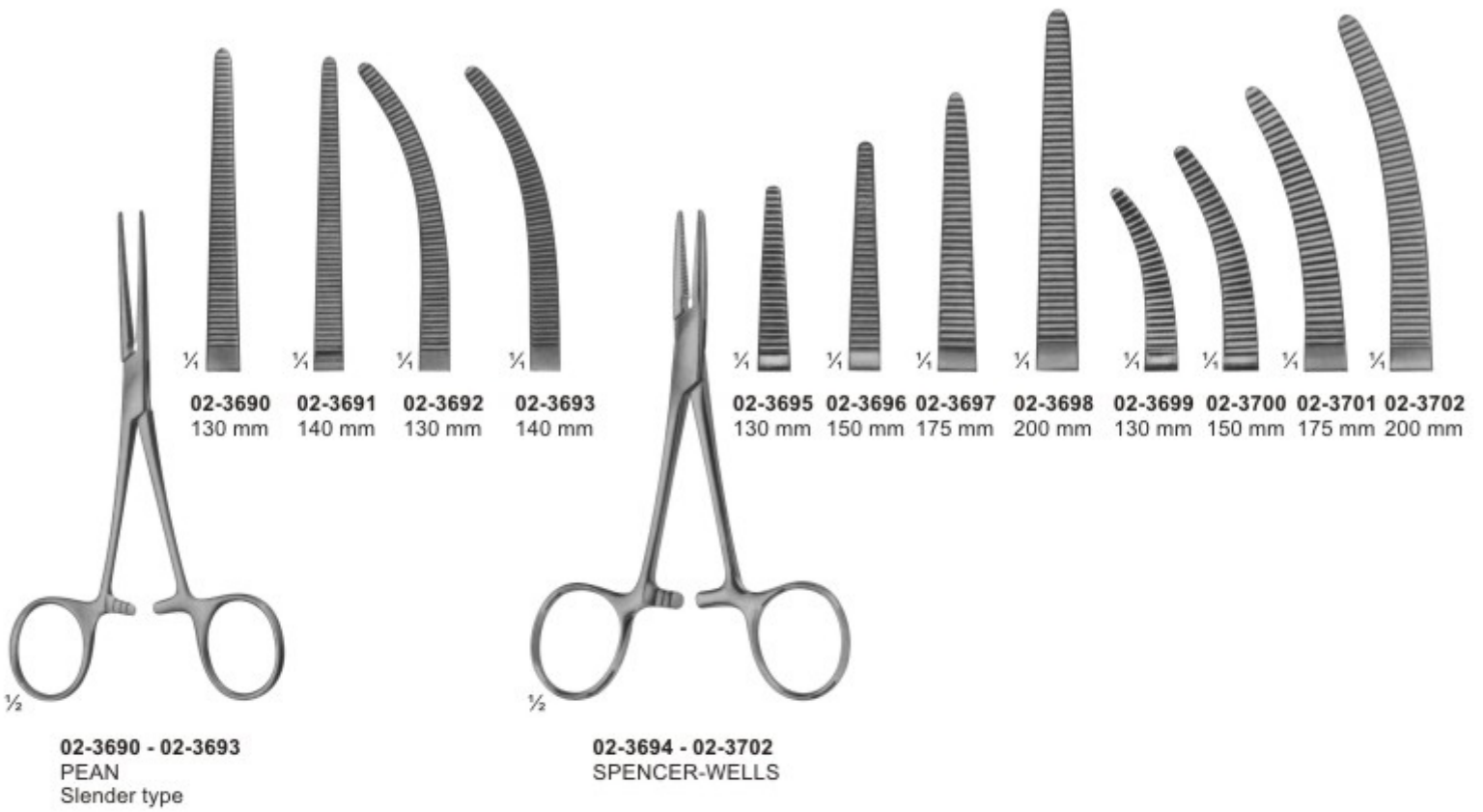

Haemostatic Forceps

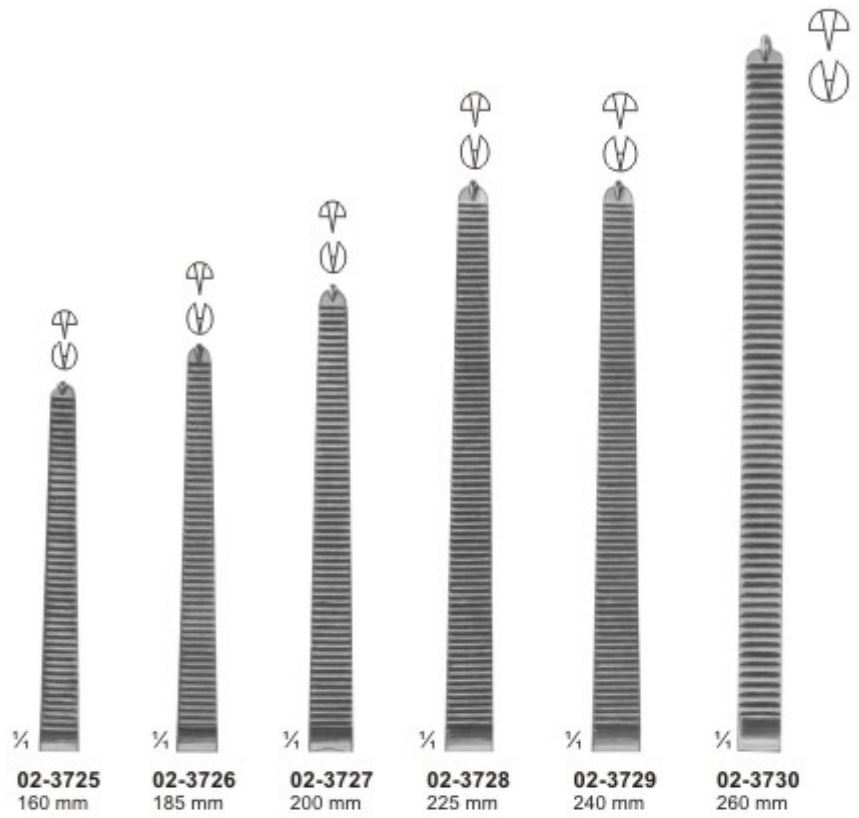

02-3725 - 02-3736
KOCHER-OCHSNER

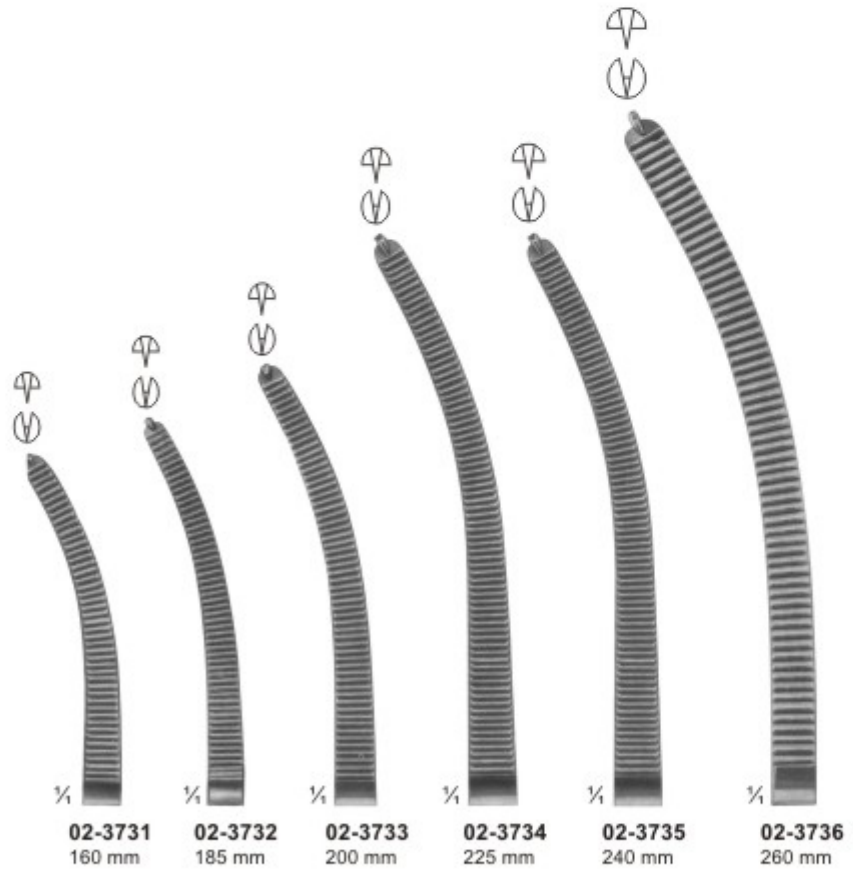

Haemostatic Forceps, Special Pattern, Tonsil Forceps

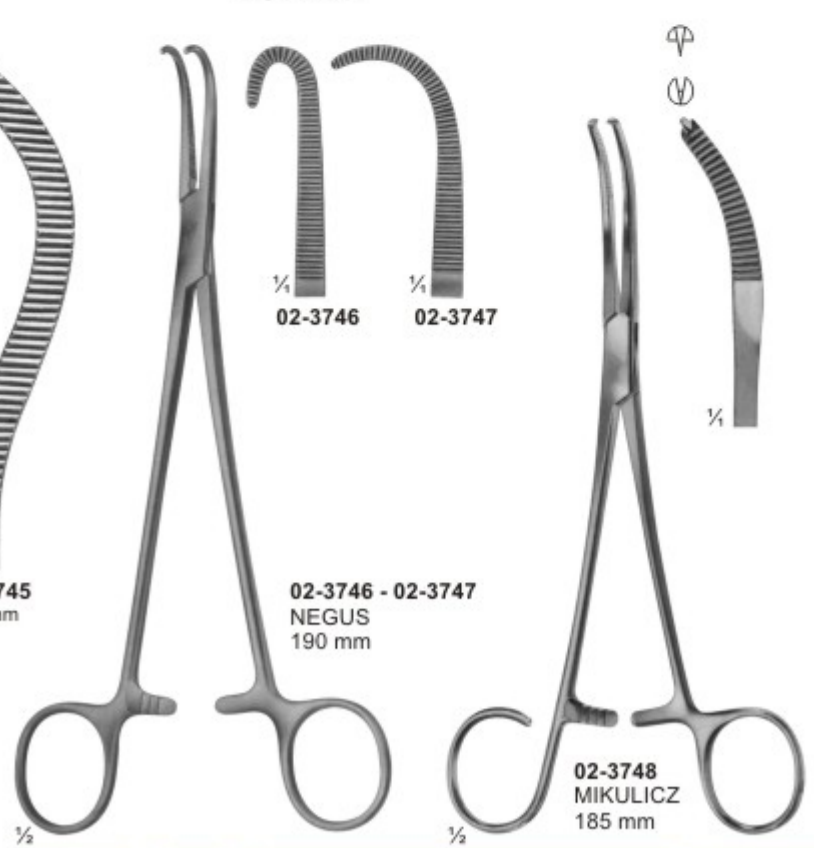
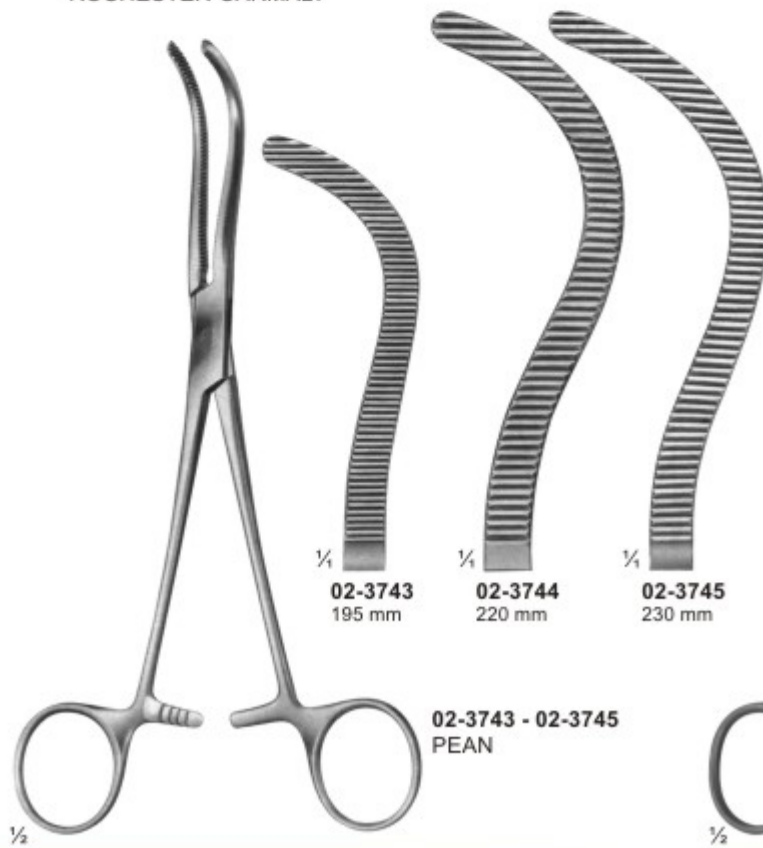
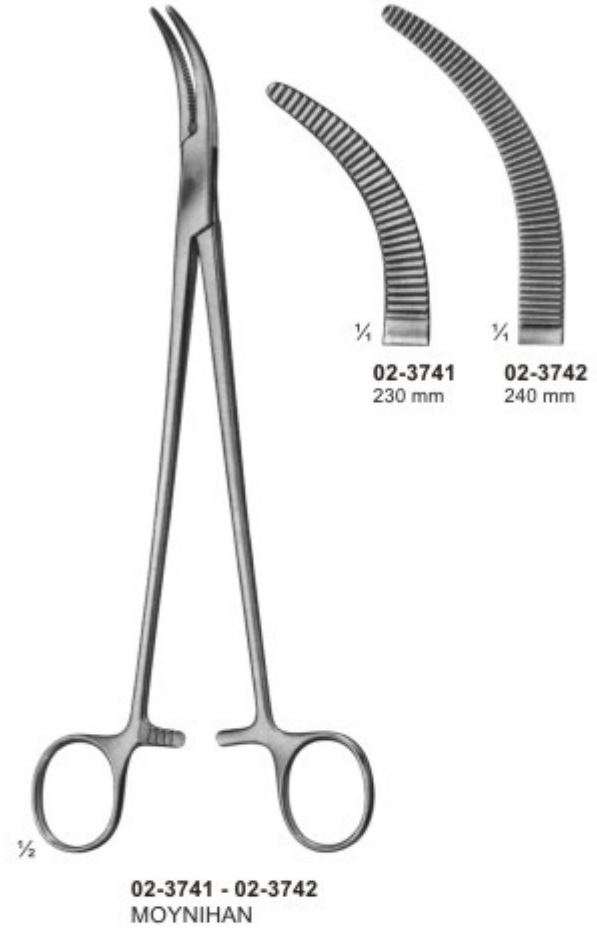

Dissecting- and Ligature Forceps



02-3749
MICRO-ADSON
140 mm



02-3750
BABY-OVERHOLT
135 mm



02-3751 - 02-3752
BABY-MIXTER

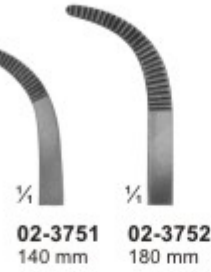

02-3753 - 02-3754
BABY-ADSON



02-3755
NISSEN



02-3756 - 02-3757
YASARGIL
195 mm

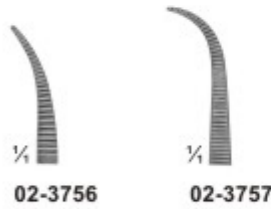

02-3758
OVERHOLT-MIXTER

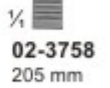

Dissecting- and Ligature Forceps

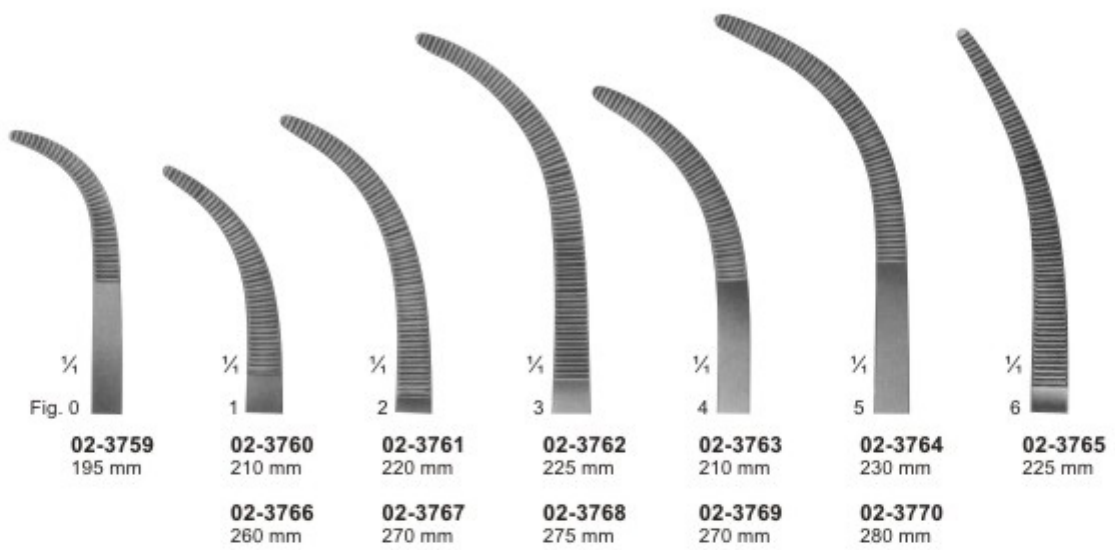

02-3759 - 02-3770
OVERHOLT-GEISSENDOERFER

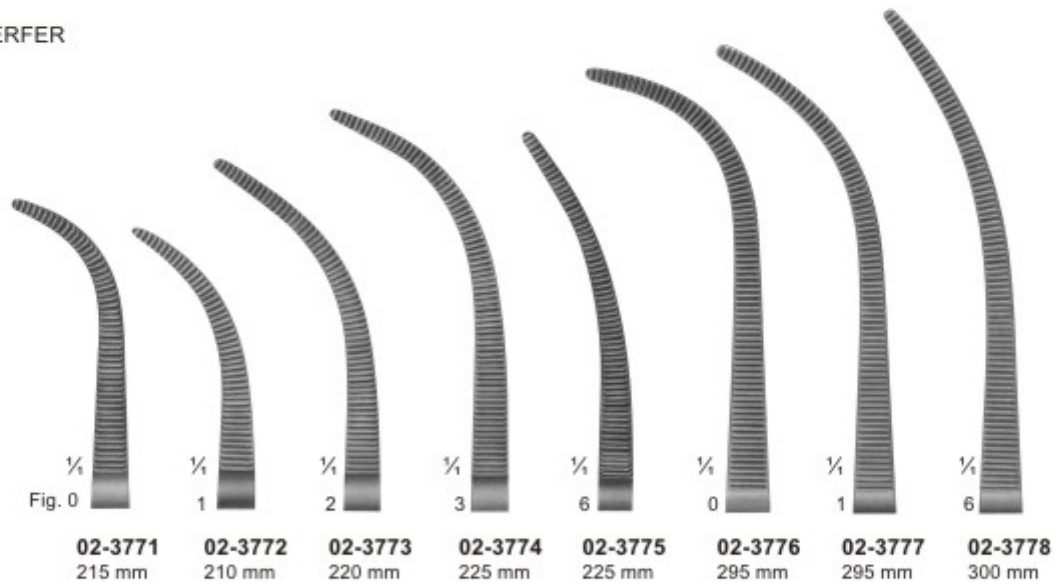

02-3771 - 02-3778
OVERHOLT
fine pattern

Dissecting- and Ligature Forceps



02-3779
MIXTER-O'SHAUGNESSY
190 mm



02-3780
HEISS
195 mm

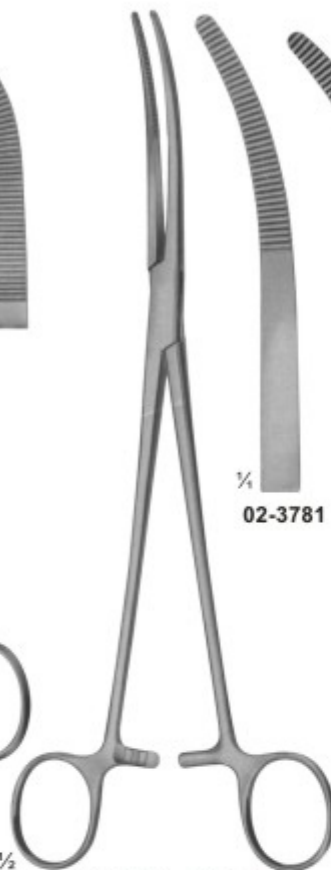

02-3781 **02-3782** **02-3783** **02-3784** **02-3785**

02-3781 - 02-3785
RUMEL
240 mm

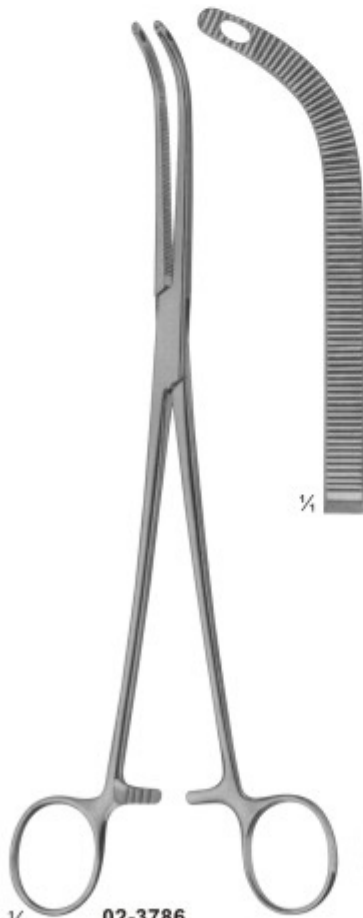

02-3786
FINOCHIETTO
245 mm



02-3787
MIXTER
230 mm



02-3788
LAWRENCE
270 mm

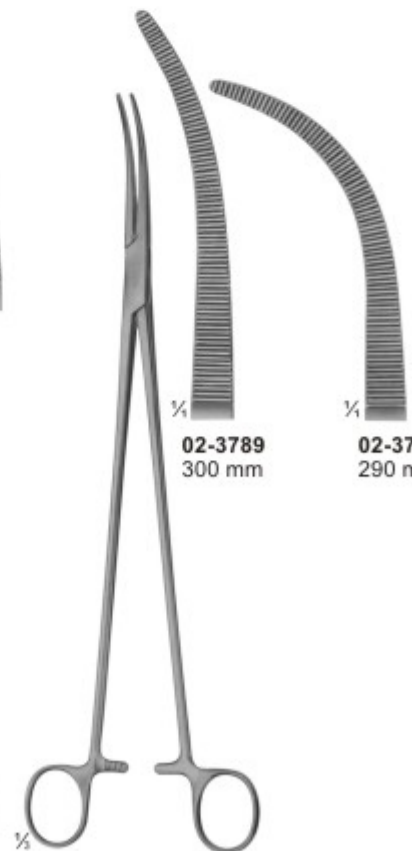

02-3789 - 02-3790
ZENKER

02-3789
300 mm

02-3790
290 mm

Dissecting- and Ligature Forceps



Peritoneum Forceps

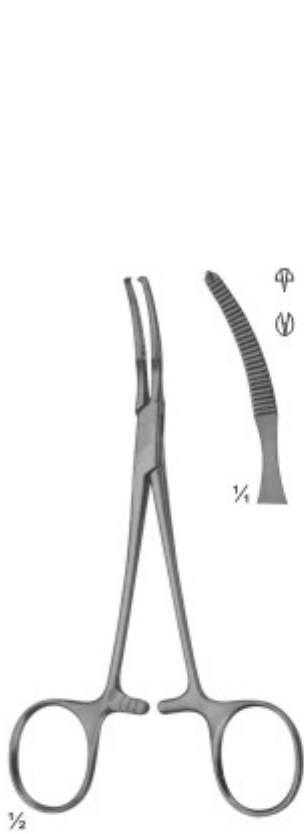

02-3799
BABY-MIKULICZ
140 mm



02-3800
MIKULICZ
185 mm

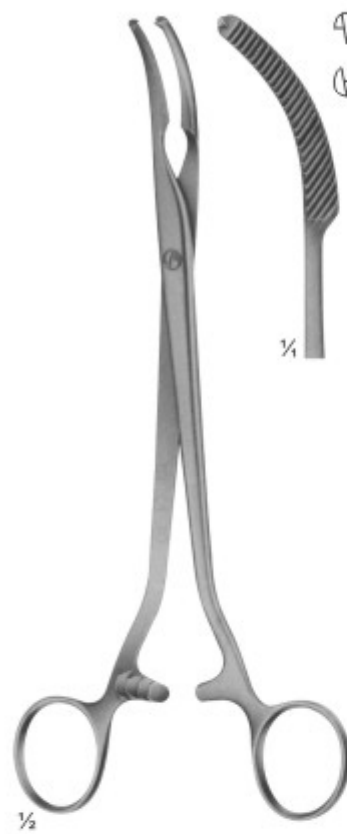

02-3801
MIKULICZ
205 mm

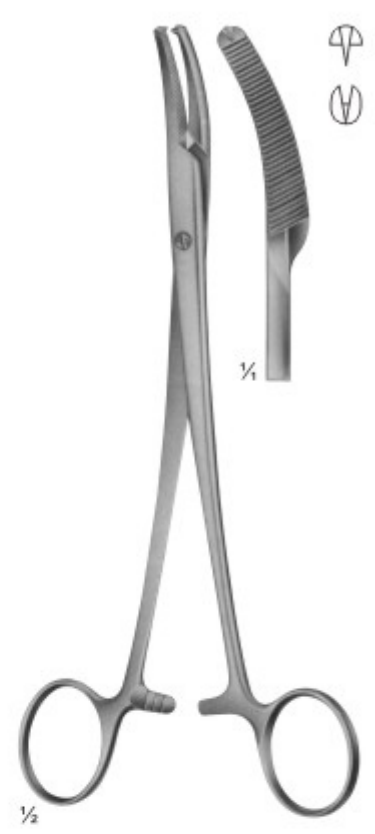

02-3802
MIKULICZ
200 mm



02-3803
MIKULICZ
205 mm

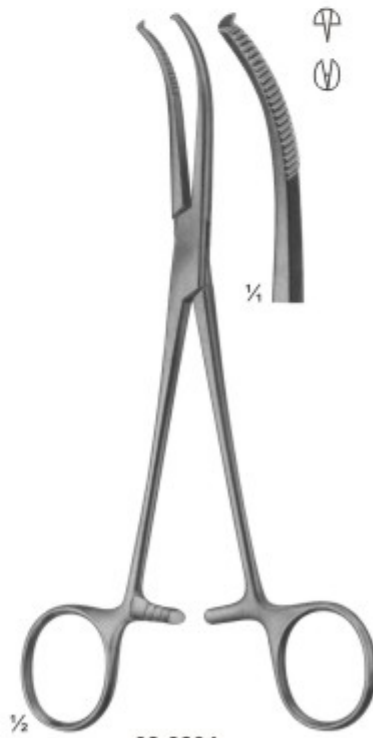

02-3804
MIKULICZ
185 mm

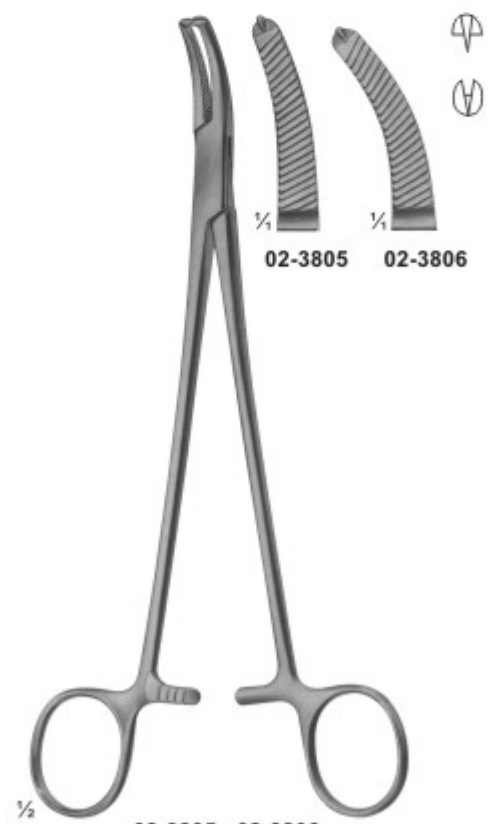

02-3805 - 02-3806
FAURE
205 mm

Hysterectomy and Haemostatic Forceps



02-3807
210 mm

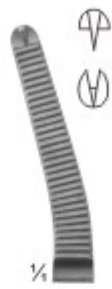

02-3808
205 mm

02-3807 - 02-3808
PHANEUF



02-3809
205 mm



02-3810
245 mm

02-3809 - 02-3810
HEANEY modif.



02-3811
195 mm

02-3811
HEANEY

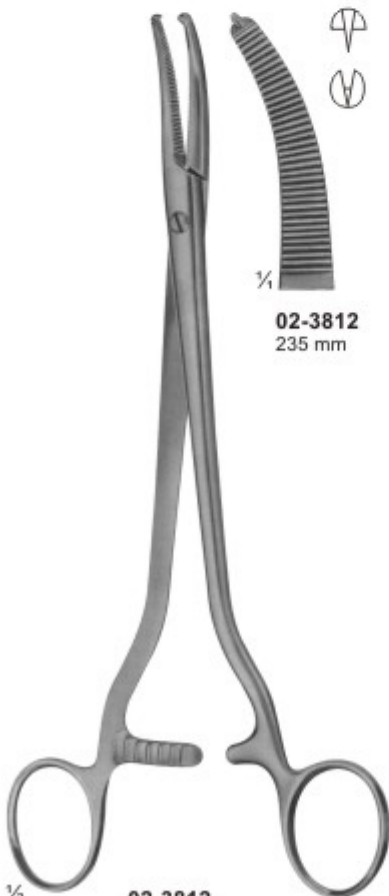

02-3812
235 mm

02-3812
WERTHEIM

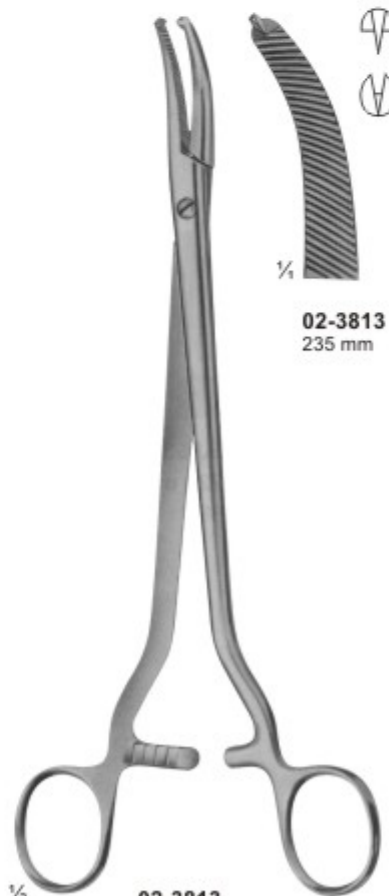

02-3813
235 mm

02-3813
WERTHEIM



02-3814
245 mm

02-3814
WERTHEIM

Atraumata Hysterectomy Forceps and Vaginal Clamps ATRAUMATA



02-3815
225 mm



02-3816
220 mm



02-3817
215 mm



02-3818
205 mm



02-3819
250 mm



02-3820
245 mm



02-3821
240 mm

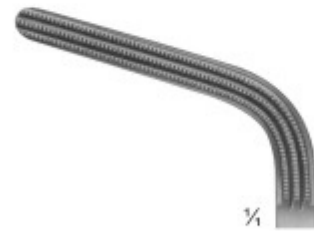

02-3822
220 mm

Hysterectomy Forceps and Vaginal Clamps and Compression Forceps ATRAUMATA



02-3823
WERTHEIM
Hysterectomy Forceps
255 mm

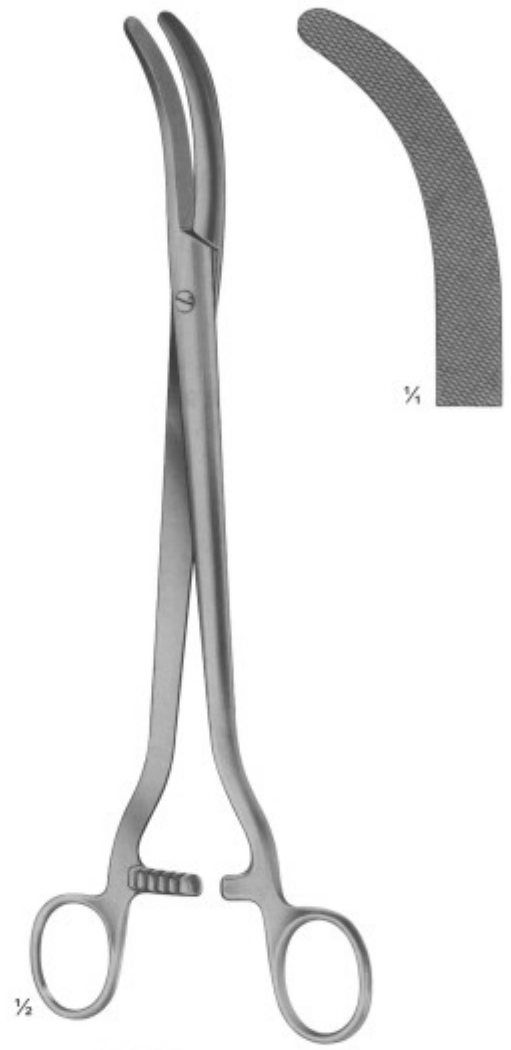

02-3824
WERTHEIM
Parametrium Clamp
260 mm

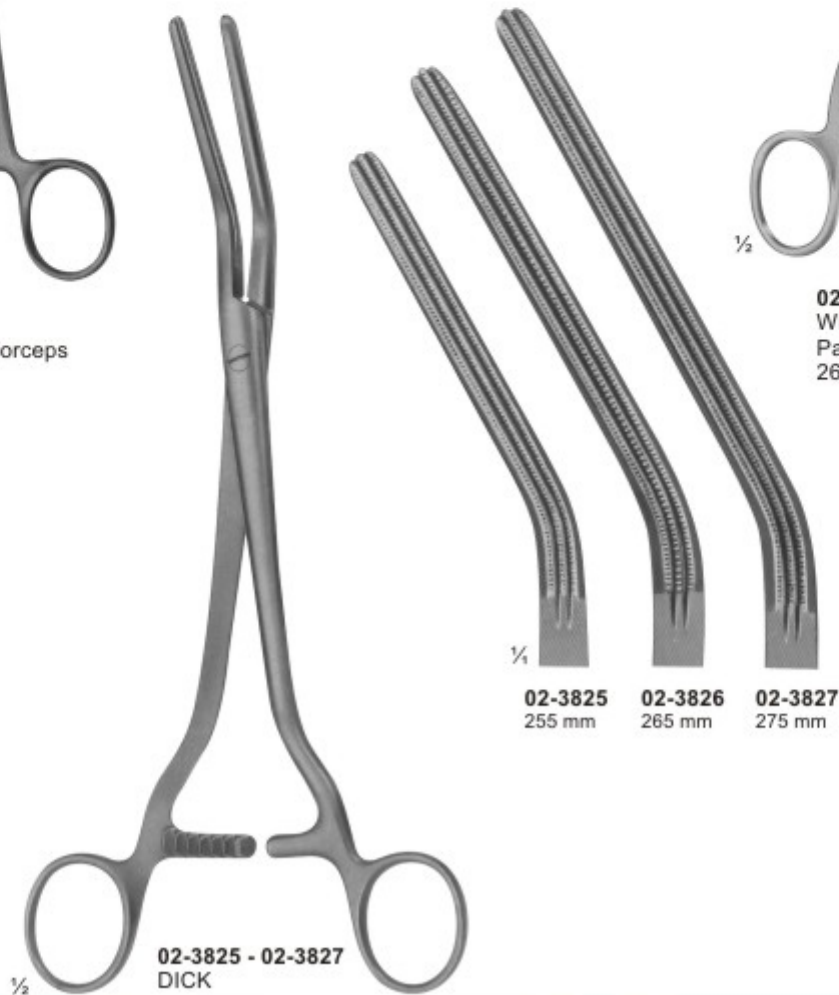

02-3825 - 02-3827
DICK

02-3825 255 mm
02-3826 265 mm
02-3827 275 mm

Clamps and Compression Forceps

ATRAUMATA



02-3828
WERTHEIM
250 mm

1/2

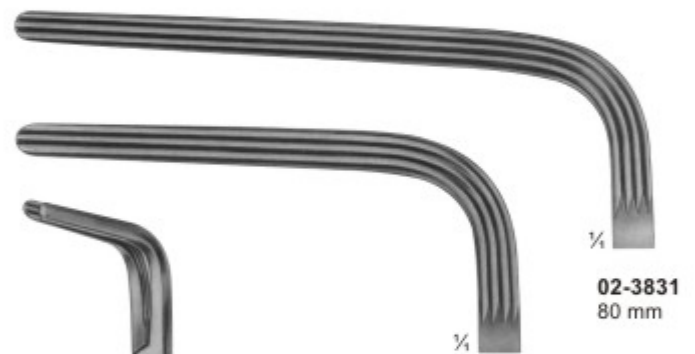

02-3831
80 mm

02-3830
60 mm



1/4



02-3830 - 02-3831
230 mm

1/2

02-3829
WERTHEIM-CULLEN
215 mm

Needle Holders For Micro Surgery



02-3832
ROHRSCHEIDER
With copper inserts
100 mm



02-3833
KALT
With catch
135 mm



02-3834
ARRUGA
With catch
135 mm



02-3835 - 02-3836
CASTROVIEJO
With catch
145 mm



02-3837 - 02-3838
CASTROVIEJO
With Catch
160 mm



02-3839 - 02-3840
Without catch
185 mm



02-3840



02-3841 - 02-3842
JACOBSON
185 mm



02-3841
Without catch

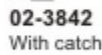

02-3842
With catch





















02-3843
Without catch
195 mm



02-3844 - 02-3845
YASARGIL
With catch
200 mm

Micro Needle Holders With Round Handles and Bayonet - Shaped

 <p>  02-3846 02-3847 115 mm 135 mm </p>	 <p>  02-3848 02-3849 </p>	 <p>  02-3850 02-3851 </p>	 <p>  02-3852 02-3853 </p>	 <p>  02-3854 </p>
<p> 02-3846 - 02-3847 BARRAQUER Without catch </p>	<p> 02-3848 - 02-3849 BARRAQUER Without catch 120 mm </p>	<p> 02-3850 - 02-3851 BARRAQUER With catch 120 mm </p>	<p> 02-3852 - 02-3853 With Catch 150 mm </p>	<p> 02-3854 MULLER With Locking Mechanism 145 mm </p>
 <p>  02-3855 02-3856 </p>	 <p>  02-3857 02-3858 </p>	 <p>  02-3859 02-3860 </p>	 <p>  02-3861 </p>	
<p> 02-3855 - 02-3856 BROCK Without catch 150 mm </p>	<p> 02-3857 - 02-3858 YASARGIL 200 mm </p>	<p> 02-3859 - 02-3860 YASARGIL 225 mm </p>	<p> 02-3861 YASARGIL 245 mm </p>	

Needle Holders

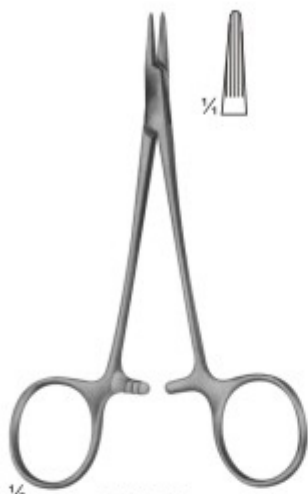

02-3862
CONVERSE
125 mm



02-3863
WEBSTER
125 mm



Smooth jaws



02-3864 - 02-3865
HALSEY
130 mm



Smooth jaws



02-3866
DERF
125 mm



02-3867
DOYEN
125 mm



02-3868
BAUMGARTNER
145 mm



02-3869
CRILE-WOOD
150 mm



Fine Pattern



02-3870
CRILE-WOOD
160 mm



Heavy pattern



02-3871
CRILE-MURRAY
150 mm



02-3872
KILNER
135 mm



02-3873
ADSON
175 mm

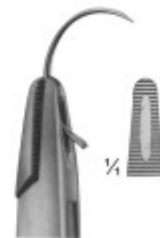

Designed for Frontal
and Palate Suture

Needle Holders

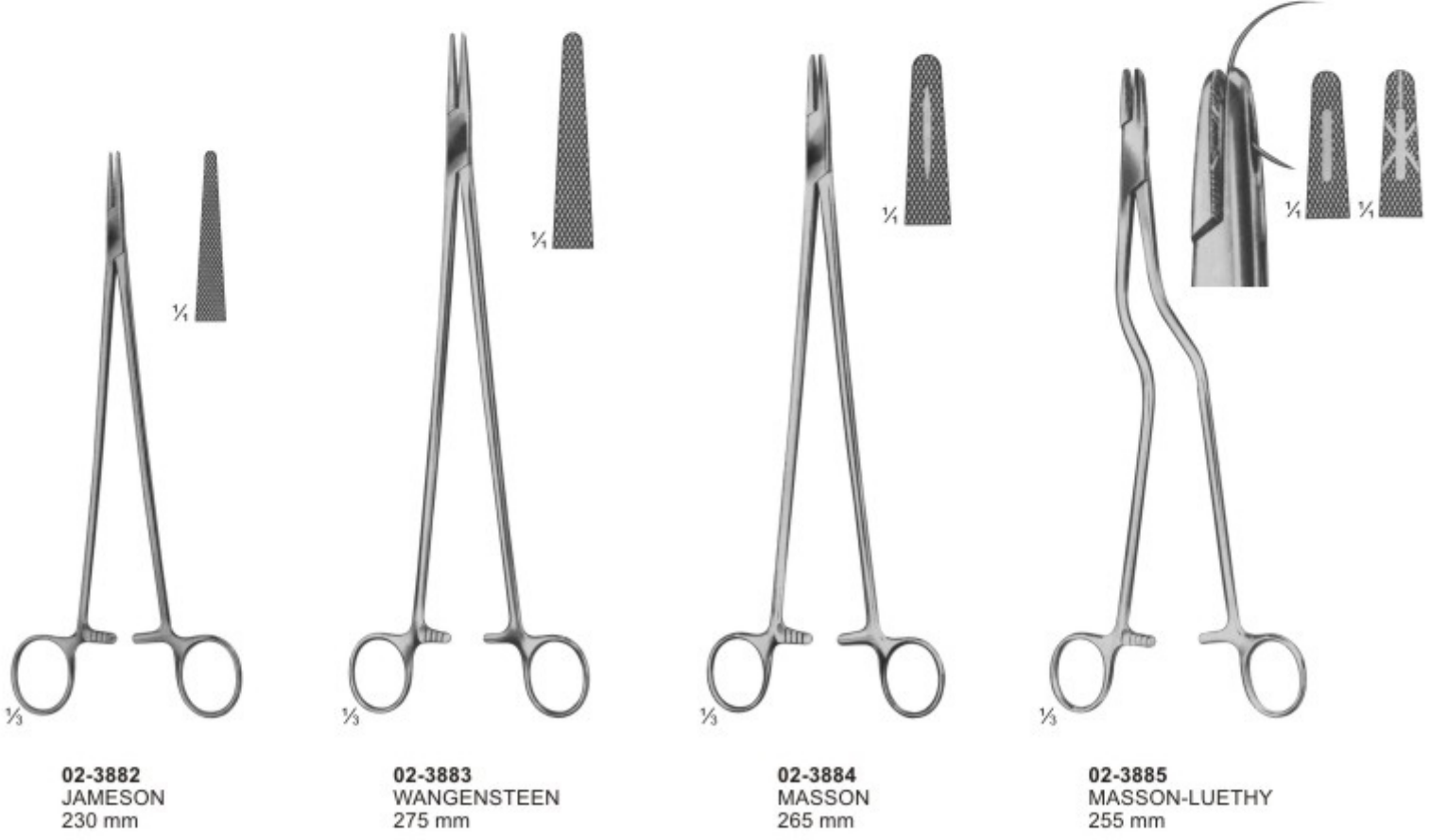

Needle Holders

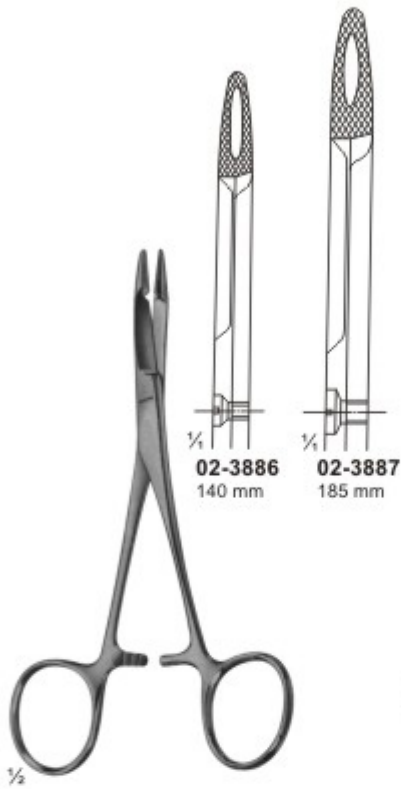

02-3886
140 mm

02-3887
185 mm

02-3886 - 02-3887
HEGAR-OLSEN
Needle Holders with Scissors

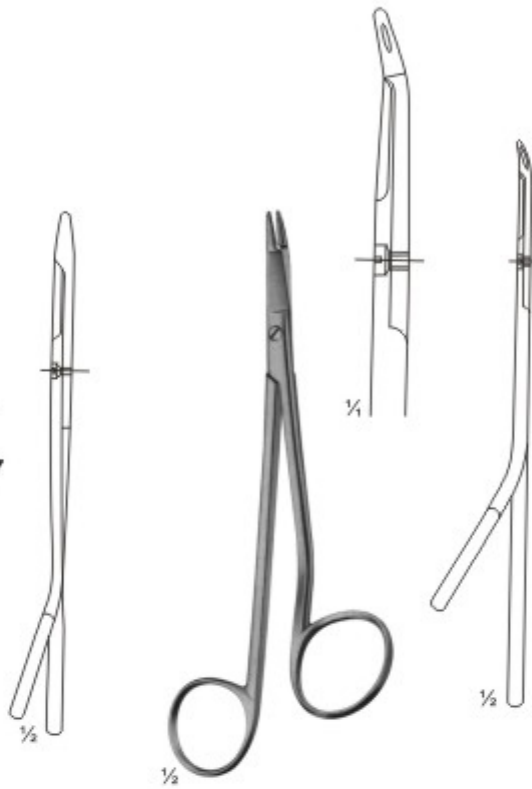

02-3888
GILLIES
Needle Holders with Scissors
150 mm

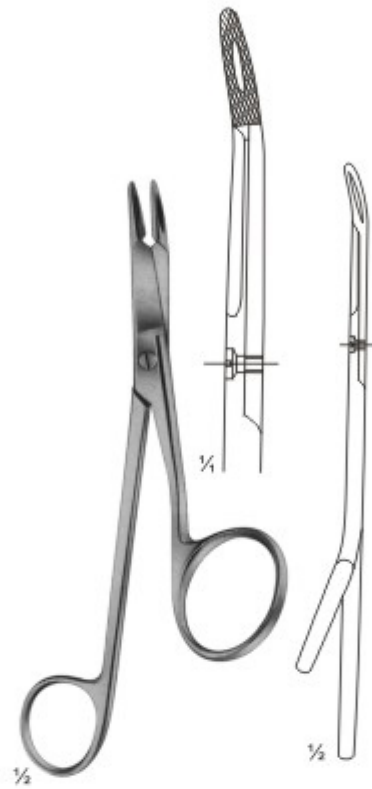

02-3889
GILLIES
Needle Holders with Scissors
160 mm

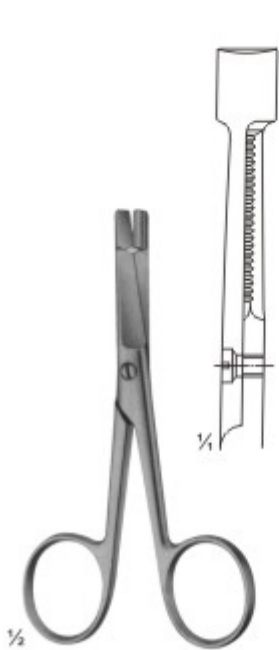

02-3890
EISELSBERG
Needle Holders with Scissors
115 mm

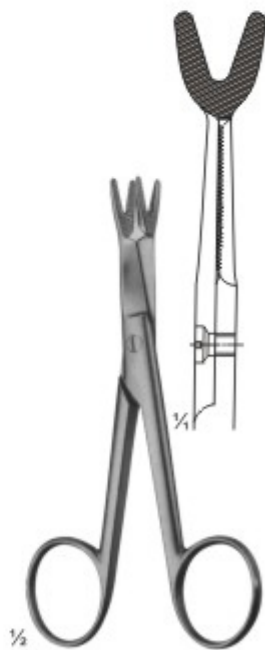

02-3891
SCHOEMAKER-LOTH
Needle Holders with Scissors
125 mm



02-3892
CRILE
150 mm



02-3893
TOENNIS
Elastic pattern for
dura- or intestinal suture
180 mm

Needle Holders

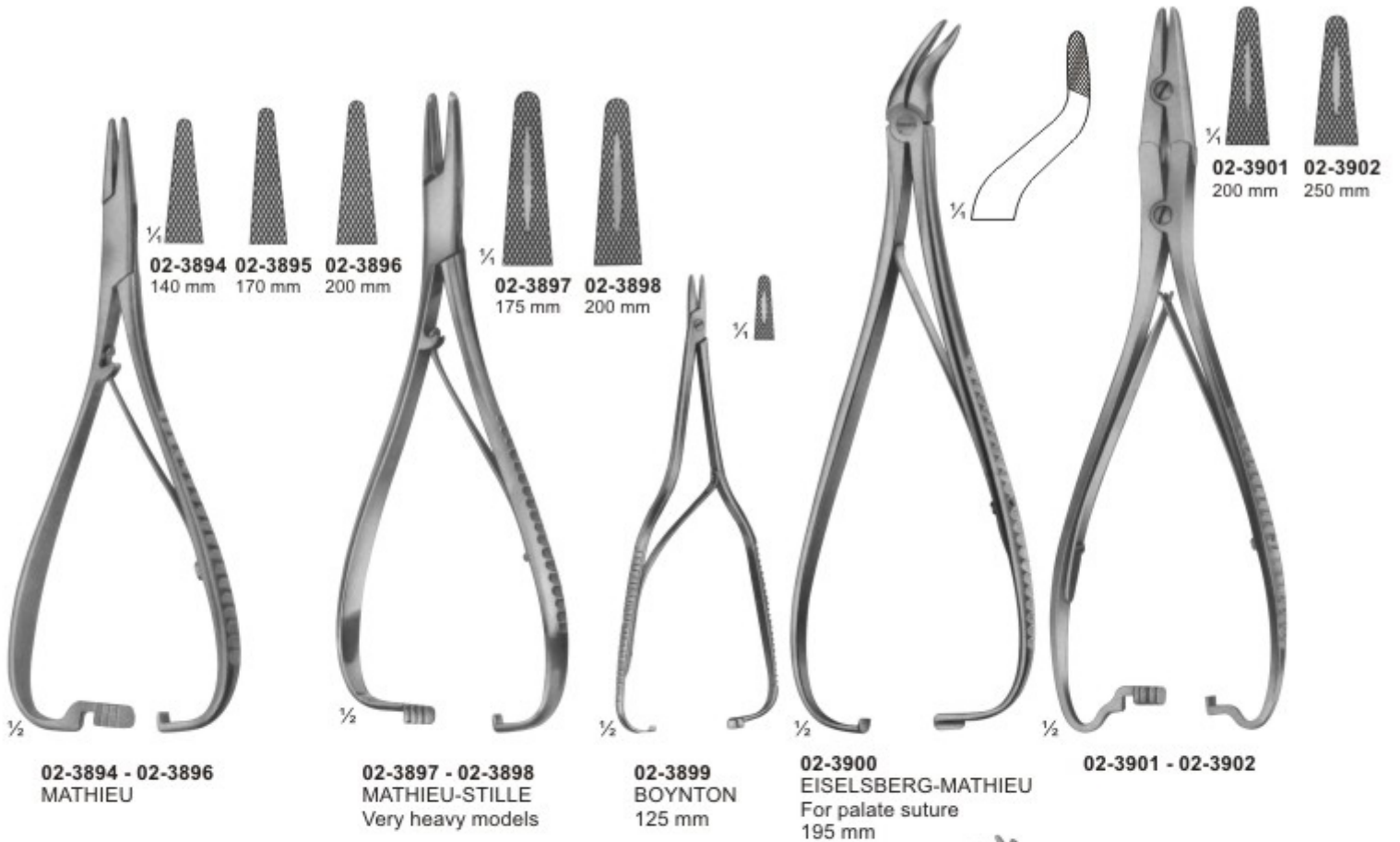

Spare Needles

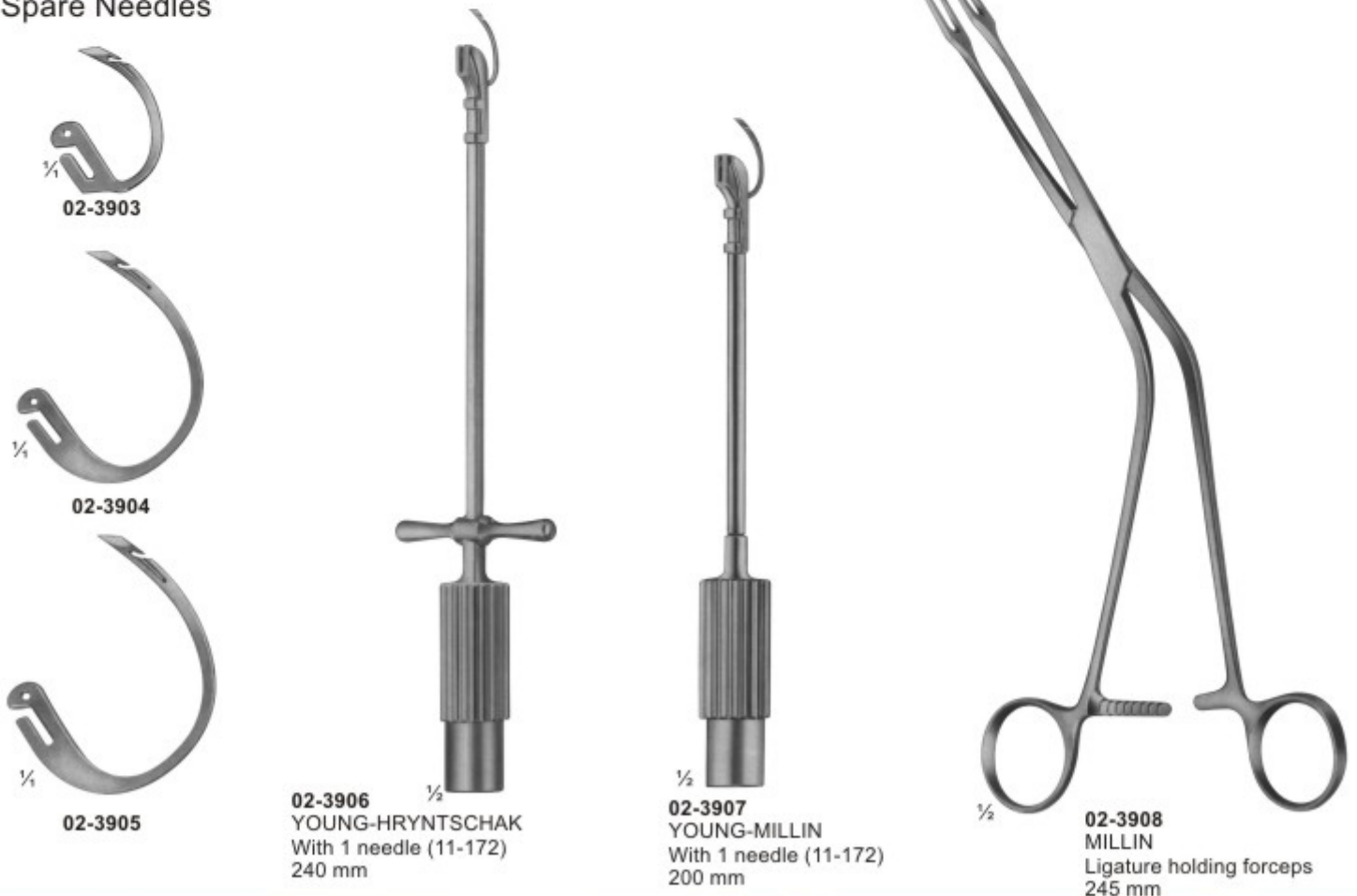

Suture Instruments - Reverdin Needles



02-3909 02-3910 02-3911 02-3912

02-3909 - 02-3912
REVERDIN
140 mm



02-3913 02-3914 02-3915 02-3916

02-3917 02-3918 02-3919 02-3920

02-3913 - 02-3916
REVERDIN
195 mm

02-3917 - 02-3920
REVERDIN
220 mm

Suture Instruments - Ligature Needles



Suture Instruments - Ligature Needles



1/2
02-3933
HURD
for right hand
sharp
210 mm



1/2
02-3934
HURD
for left hand
sharp
210 mm



1/2
02-3935
DESCHAMPS
for right hand
sharp
215 mm



1/2
02-3936
DESCHAMPS
for left hand
sharp
215 mm



1/2
02-3937
JONESCO
Needle for wire suture
185 mm



1/2
02-3938
CLAUS VAN EICKEN
Needle for wire suture
250 mm



1/2
02-3939
150 mm

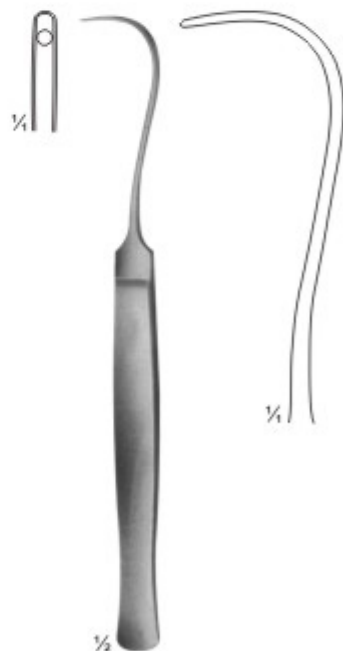

1/2
02-3940
SYME
170 mm



1/2
02-3941
COOPER
205 mm

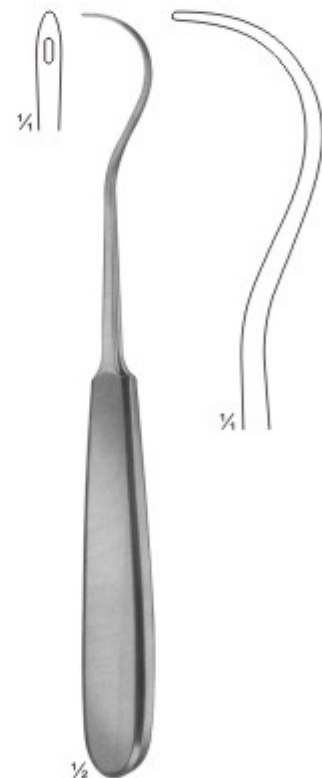

1/2
02-3942
KOCHER
205 mm

Ligature Needles

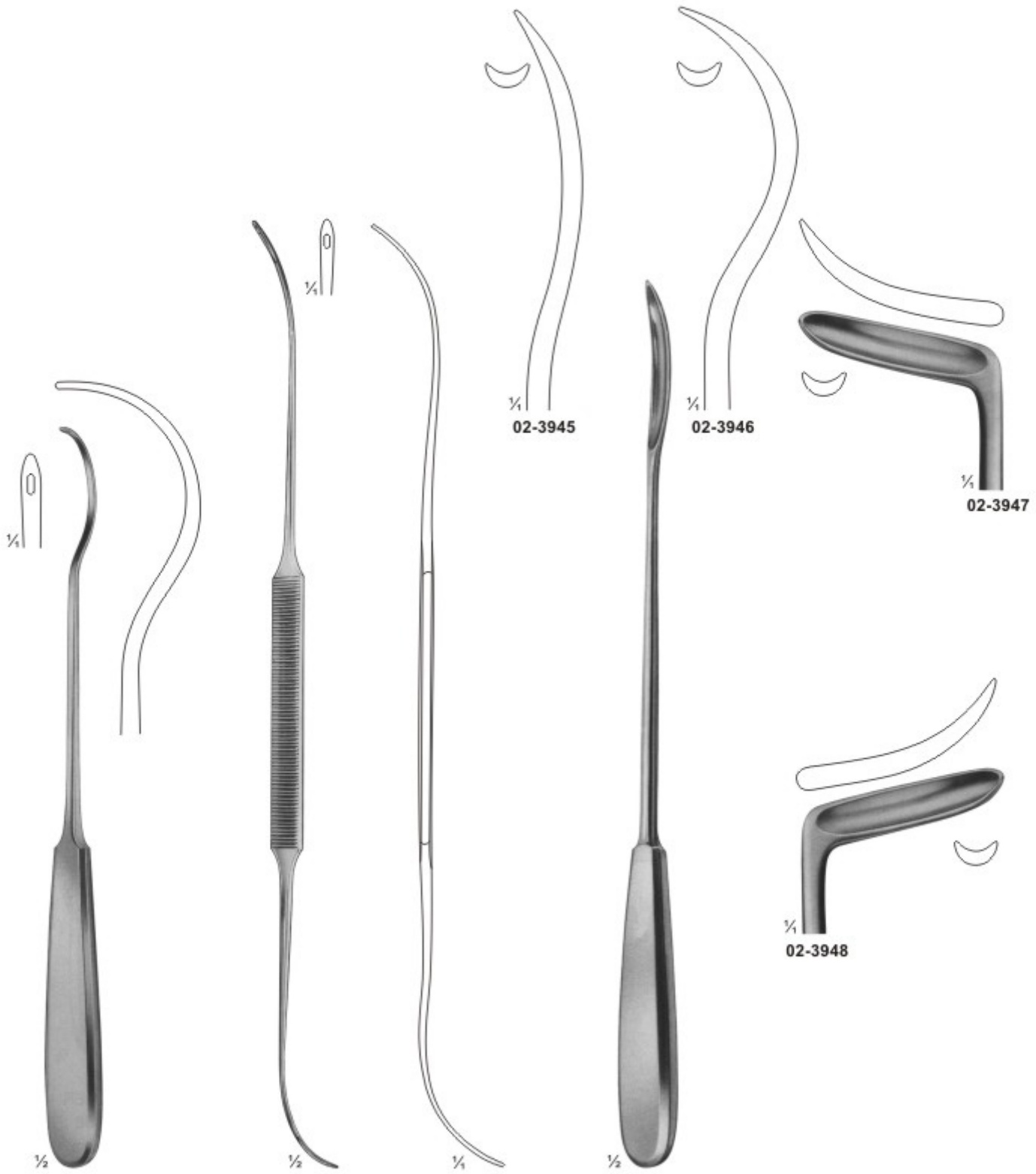

02-3943
BRUNNER
240 mm

02-3944
SCHMIEDEN-DICK
Malleable / Flexible
320 mm

02-3945 - 02-3946
BRUNNER
Guiding Probes
300 mm

02-3947

02-3948

Guiding Probes and Suture Instruments

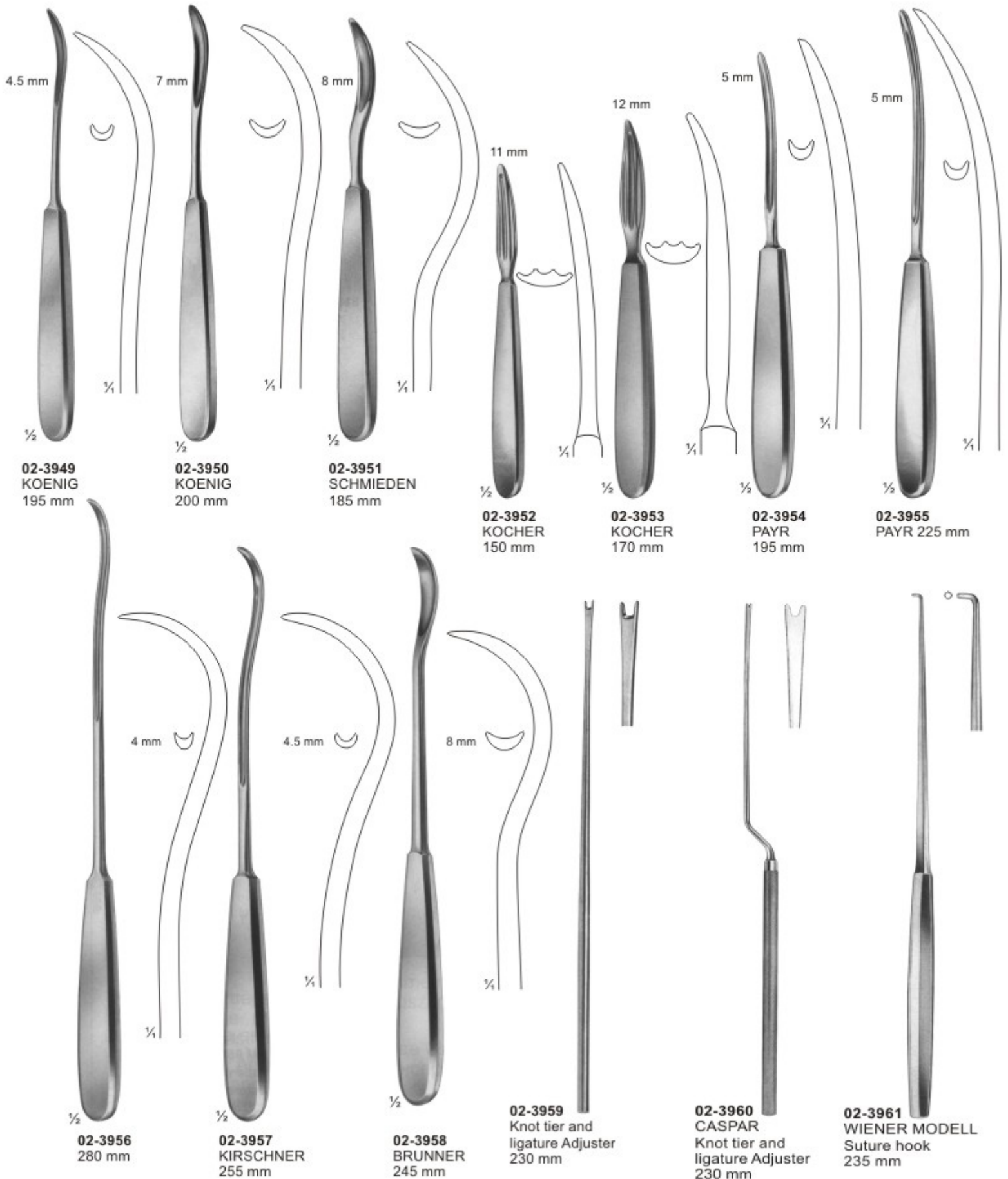

Directors and Probes

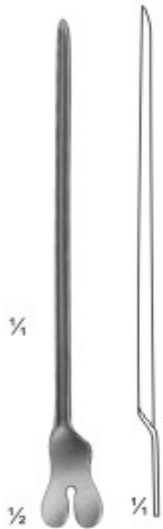

02-3962 - 02-3964
 02-3962 130 mm
 02-3963 145 mm
 02-3964 160 mm
 Directors



02-3965
 DOYEN
 145 mm
 Directors



02-3966
 NELATON
 160 mm
 Directors



02-3967
 Director with tip
 Diam. Of tip 3,3 mm
 140 mm

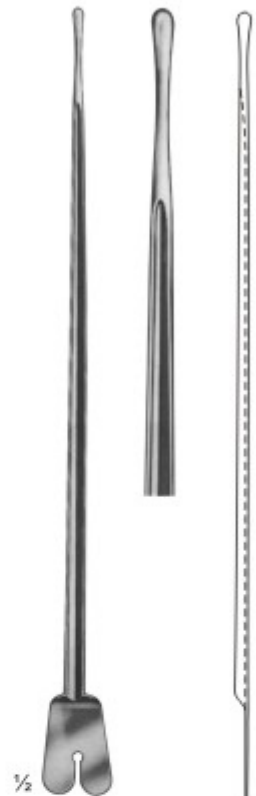

02-3968
 BRODIE
 Director with tip,
 Diam. Of tip 3,5 mm
 200 mm

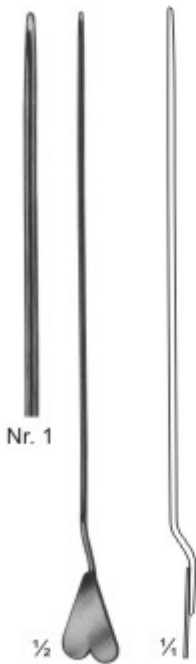

02-3969
 LOCKHART-MUMMERY
 165 mm
 Straight

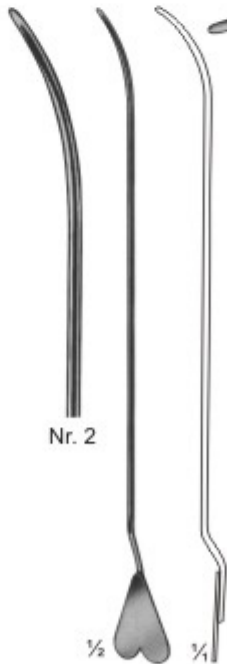

02-3970
 LOCKHART-MUMMERY
 165 mm
 45° Curved

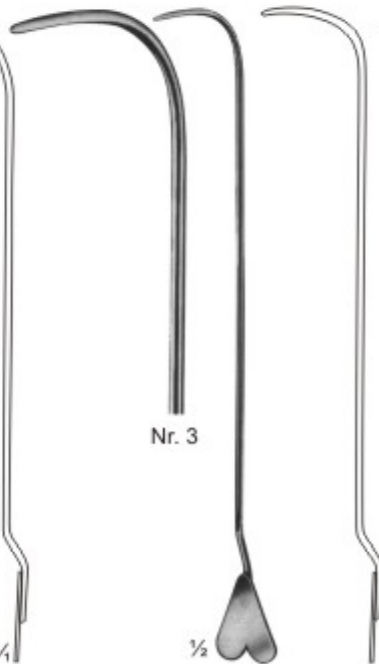

02-3971
 LOCKHART-MUMMERY
 165 mm
 90° Curved

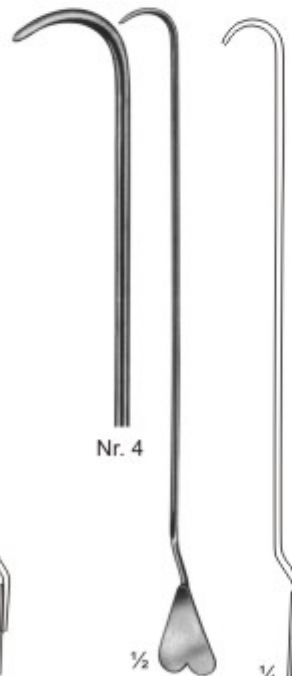

02-3972
 LOCKHART-MUMMERY
 165 mm
 Retrograde Curved



02-3973
 Director with wire
 loop, malleable
 190 mm

Probes

02-3974
 2,5 mm \varnothing
02-3975
 2,5 mm \varnothing
02-3976
 3,0 mm \varnothing



1/2

02-3974 - 02-3976
02-3974 145 mm
02-3975 160 mm
02-3976 200 mm
 Probes with eye

1,5 mm \varnothing



1/2

02-3977
 Myrtle leaf probe
 145 mm

2,0 mm \varnothing



1/2

02-3978 - 02-3982
 Myrtle leaf probe
02-3978 130 mm
02-3979 145 mm
02-3980 160 mm
02-3981 180 mm
02-3982 200 mm



1/2

02-3983
 Probes

diam. of tips			Length
1 mm	1.5 mm	2 mm	
-	02-3984	-	130mm
02-3985	02-3986	02-3991	145mm
-	02-3987	02-3992	160mm
-	02-3988	02-3993	180mm
-	02-3989	02-3994	200mm
-	02-3990	-	250mm
-	-	02-3995	300mm



1/2

02-3996
 Double ended probe,
 malleable, diam. of tips
 3 mm with hole
 190 mm



02-3997
 250mm 300mm
 Double ended probes,
 tin, malleable, diam. of tips
 3,5 mm with hole



1/4

02-3998
 Double ended probe,
 tin, malleable,
 diam. of tips 4 mm
 400 mm



1/2

\varnothing tip
02-3999 - 02-4001
02-3999 1,5 mm
02-4000 2,0 mm
02-4001 2,5 mm
 300 mm Probes

Probes - Spatulas - Cotton Applicators



02-4002
STACKE
Silver
100 mm
Ø 0.8mm



02-4003
KILLIAN
165 mm
Ø 1.5mm



02-4004
160 mm
Ø 1.4mm



02-4005
SEIFFERT
Silver
180 mm
Ø 0.5mm



02-4006
BOWMAN
130 mm

German Silver

- 02-4007 - 02-4011**
02-4007 0.7+0.8mm Ø Fig. 00/0
02-4008 0.9+1.1mm Ø Fig. 1/2
02-4009 1.3+1.4mm Ø Fig. 3/4
02-4010 1.5+1.6mm Ø Fig. 5/6
02-4011 1.8+1.9mm Ø Fig. 7/8



02-4012
SPATULA
145 mm



02-4013
SPATULA
145 mm



02-4014 Ø
Modell PICCOLO
Round Serrated end
110 mm 0.7mm



02-4015 Ø
Modell PICCOLO
Triangular Serrated end
110 mm 0.7mm















02-4016 Ø
FARRELL
Round Serrated end
110 mm 1.2mm



02-4017 Ø
LATHBURY-FARRELL
Triangular Serrated end
110 mm 1.4mm

Cotton Applicators

						
<p>02-4018 BUCK Rough, spiral end Ø120 mm 0.9mm</p>	<p>02-4019 Triangular serrated end Ø140 mm 0.9mm</p>	<p>02-4020 Rough, spiral end Ø140 mm 1.0mm</p>	<p>02-4021 Rough, spiral end Ø140 mm 1.2mm</p>	<p>02-4022 Rough, spiral end Ø140 mm 1.8mm</p>	<p>02-4023 FARRELL Round, serrated end Ø140 mm 1.2mm</p>	<p>02-4024 LATHBURY-FARRELL Triangular, serrated end 140 mm Ø1.4mm</p>
						
<p>02-4025 FARRELL Rough, spiral end Ø160 mm 1.2mm</p>	<p>02-4026 LATHBURY-FARRELL Triangular, serrated end 160 mm Ø1.2mm</p>	<p>02-4027 Triangular, serrated end Ø160 mm 1.4mm</p>	<p>02-4028 Rough, spiral end Ø180 mm 1.5mm</p>	<p>02-4029 Rough, spiral end Ø180 mm 1.8mm</p>	<p>02-4030 Rough, spiral end Ø270 mm 2.5mm</p>	

Clip Applying Forceps, Clip Applying - and Removing Forceps



02-4031
MICHEL
125 mm



02-4032
HEGENBARTH
120 mm



02-4033
WACHENFELDT
120 mm



02-4034
WACHENFELDT
120 mm



02-4035
MICHEL
125 mm



02-4036
MICHEL modif.
130 mm



02-4037
HEATH
135 mm



02-4038
COLLIN
135 mm

Suturing Instrument Set, Pocket Instrument Set



02-4039

Suturing instruments set, in metal case consisting of:
 1 michel clip applying and removing forceps,
 1 Scissors, curved, sharp/sharp, 115mm
 25 MICHEL clips, 16 x 3mm 1Delicate tissue forceps, 130mm
 1 Scalpel, bellied 1 MATHIEU needle holder, 140mm
 1 Perforated metal case, stainless
 containing:
 1 Suture needle
 1 Suture needle
 1 Suture needle

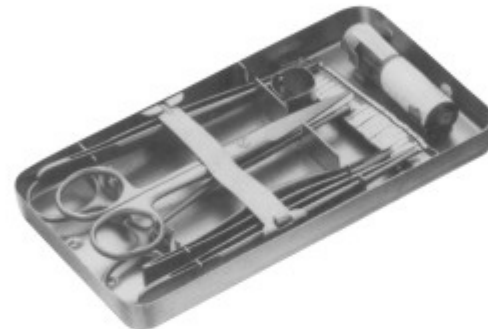

02-4040

Pocket instrument set, in metal case consisting of:

Bottom tray

1 MATHIEU needle holder, 140mm
 1 MICHEL clip forceps, combined
 1 Myrtle leaf probe, 130mm
 1 Sharp double curette
 1 Skin hook
 1 Detachable scalpel handle, no.4
 1 Perforated metal case, containing
 6 Scalpel blades
 1 Perforated metal case, stainless, containing
 1 Suture needle
 1 Suture needle
 1 Suture needle

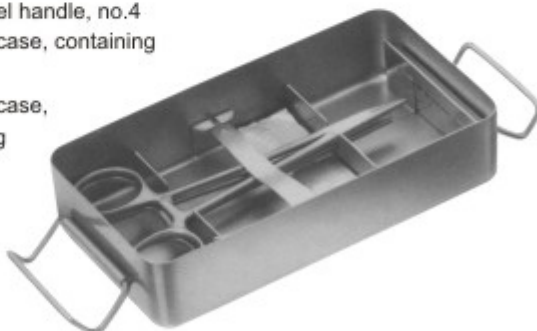

Top tray

1 Tissue forceps, 130mm
 1 KOCHER haemostatic forceps, 130mm
 1 Straight surgical scissors, 130mm
 1 Dissecting forceps, 130mm
 1 FEILCHENFELD splinter forceps, 115mm
 25 MICHEL clip, 16 x 3mm
 1 Flacon of suture skin, sterile in alcohol

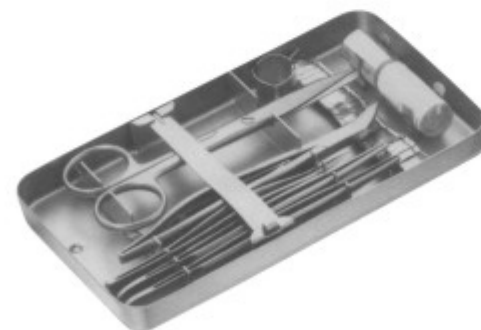

02-4041

Pocket instrument set, in metal case consisting of:

Bottom tray

1 MAYO-HEGER needle holder, 150mm
 1 MICHEL clip forceps, combined 1 Myrtle leaf probe, 130mm
 1 Sharp double curette 1 Skin hook 1 Detachable scalpel handle, no. 4
 1 Perforated metal case, consisting
 6 Scalpel blades
 1 Perforated metal case, stainless, consisting:
 1 Suture needle
 1 Suture needle
 1 Suture needle

Top tray

1 Tissue forceps, 130mm
 1 CRILE haemostatic forceps, 140mm
 1 Straight surgical scissors, 130mm
 1 Dissecting forceps, 130mm
 1 FEILCHENFELD splinter forceps, 115mm
 25 MICHEL clip, 16 x 3mm
 1 Flacon of suture silk, sterile in alcohol

Pocket Instrument Set, Venae Sectio Set

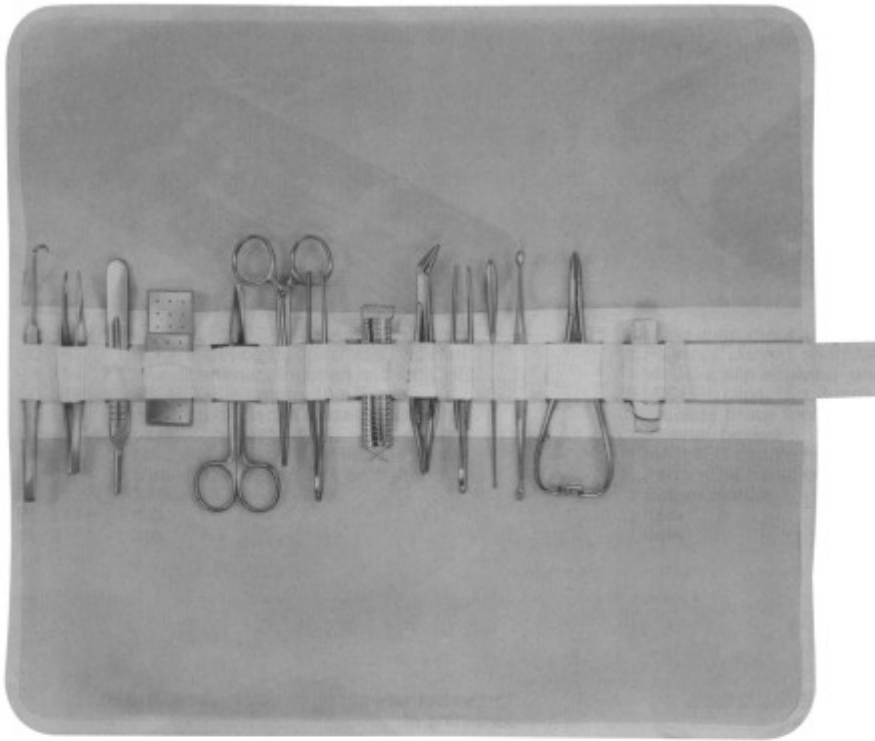

02-4042

Pocket instrument set in metal case 170 x 90mm canvas roll only, sterilizable in autoclave.

consisting of:

- 1 Myrtle leaf probe, 130mm
- 1 Sharp double curette
- 1 FEILCHENFELD splinter forceps, 115mm
- 1 Dissecting forceps, 130mm
- 1 Tissue forceps, 130mm

- 1 Straight surgical scissors, 130mm
- 1 Scalpel handle no. 4
- 1 Perforated metal case, consisting 6 scalpel blades
- 1 KOCHER haemostatic forceps, 130mm
- 1 Skin hook
- 1 MATHIEU needle holder, 140mm
- 1 Tube of suture skin, sterile in alcohol
- 1 MICHEL clip forceps, 120mm



- 25 MICHEL clip, 16 x 3mm
- 1 Perforated metal case, stainless, consisting:
- 1 Suture needle
- 1 Suture needle
- 1 Suture needle

02-4043

Canvas roll only, sterilizable in autoclave

Suitable Metal Cases

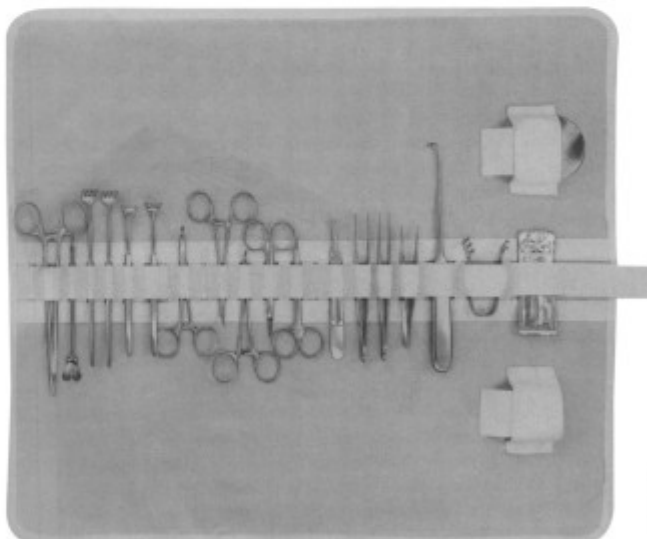

02-4044

Venae sectio set, canvas roll only, sterilizable in autoclave.

consisting of:

- 2 Tissue forceps, 1 x 2 teeth, 140mm
- 1 Dissecting forceps, 145mm
- 1 FEILCHENFELD splinter forceps, 115mm
- 1 Straight scissors, sharp, 110mm
- 1 Curved scissors, blunt, 115mm
- 3 HALSTED mosquito forceps, curved on flat, 125mm

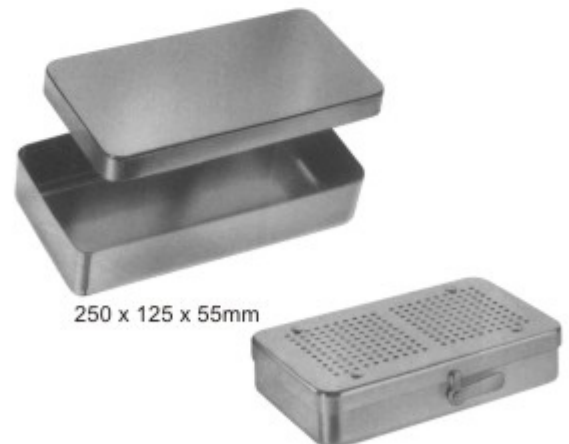

250 x 125 x 55mm

233 x 148 x 57mm

- 1 DESCHAMPS needle, blunt, 210mm
- 1 DOYEN Director, curved, 140mm
- 2 Wound retractors, 4 blunt prongs, 160mm
- 2 DESMARRES wound retractors, 135mm
- 1 FINSSEN retractors, 2 x3 blunt prongs, 80mm
- 1 Scalpel handle no. 4
- 4 Sterile scalpel blades, no 18, single peel pack
- 1 Needle box, perforated, round, diam. 65mm
- 1 HEGAR-MAYO DUROGRIP needle holder, 180mm

02-4045

Canvas roll only, sterilizable in autoclave

Venae Sectio Set

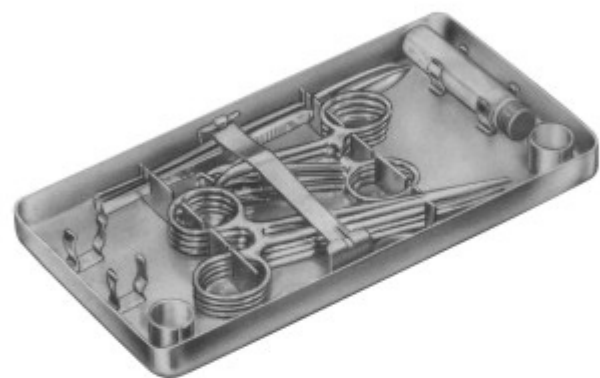

02-4046

Venae sectio set, in metal case
consisting of:

Bottom tray

- 1 MATHIEU needle holder, fine pattern 140mm
- 1 Ligature needle, fine short pattern
- 1 DOYEN director, curved
- 1 HEGENBARTH clip forceps,
- 1 ELSCHNIG tissue forceps, 1 x 2 teeth fine, 105mm
- 1 Dressing forceps, fine 105mm
- 1 Tissue forceps, 1 x 2 teeth, 110mm
- 1 Vessel scissors, straight, with 1 ball point, 110mm
- 1 Vessel scissors, curved, pointed 105mm
- 1 FINSSEN retractor
- 1 Perforated needle case

Top tray

- 1 Scalpel, pointed
- 1 Scalpel, bellied
- 2 HALSTED mosquito forceps, curved, 125mm
- 2 HALSTED mosquito forceps, straight, 1x 2 teeth, 125mm
- 3 BACKHAUS towel forceps, 90mm
- 2 Flacon holder

Nerve - and Vessel Hooks

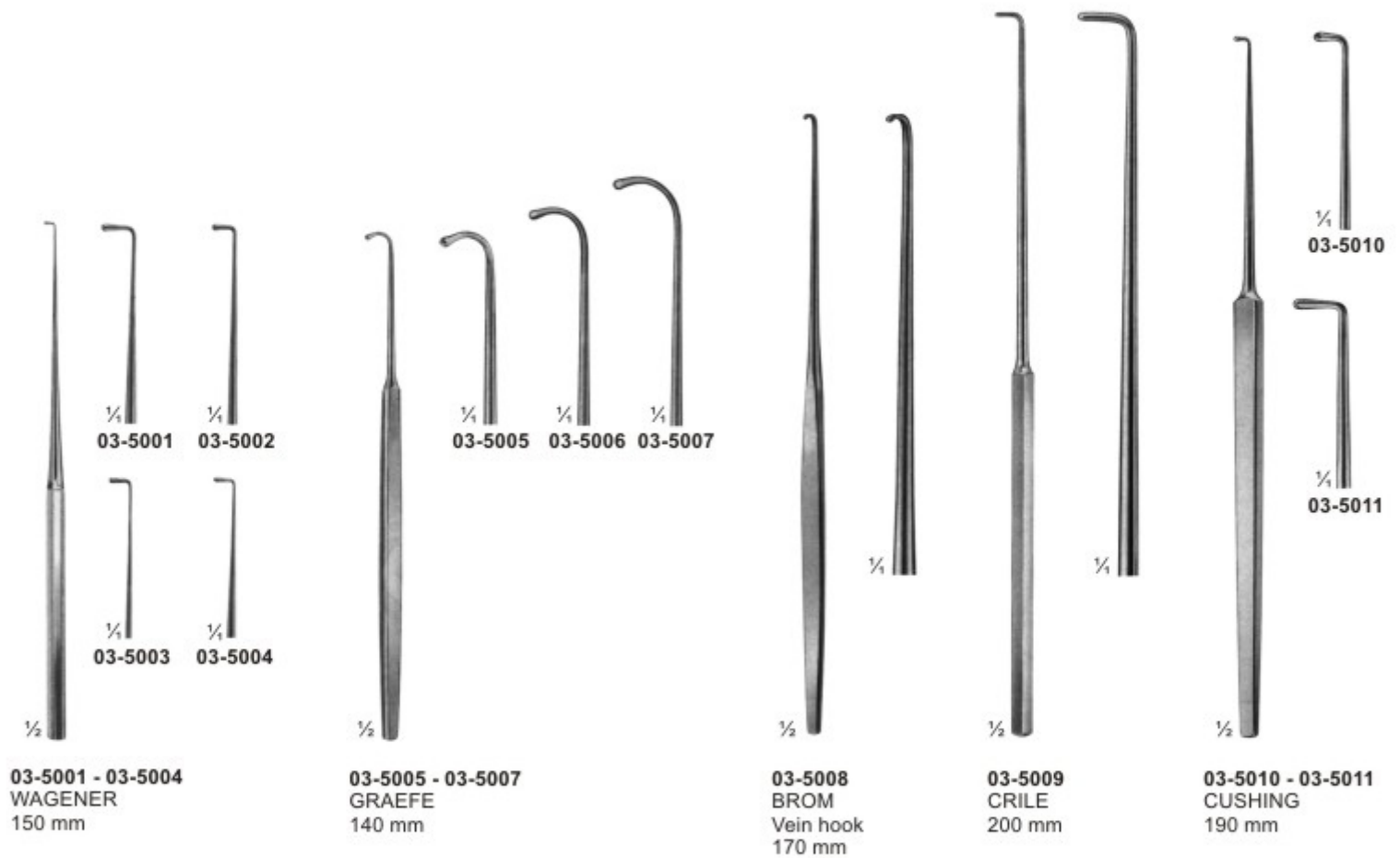

Nerve - and Vessel Hooks

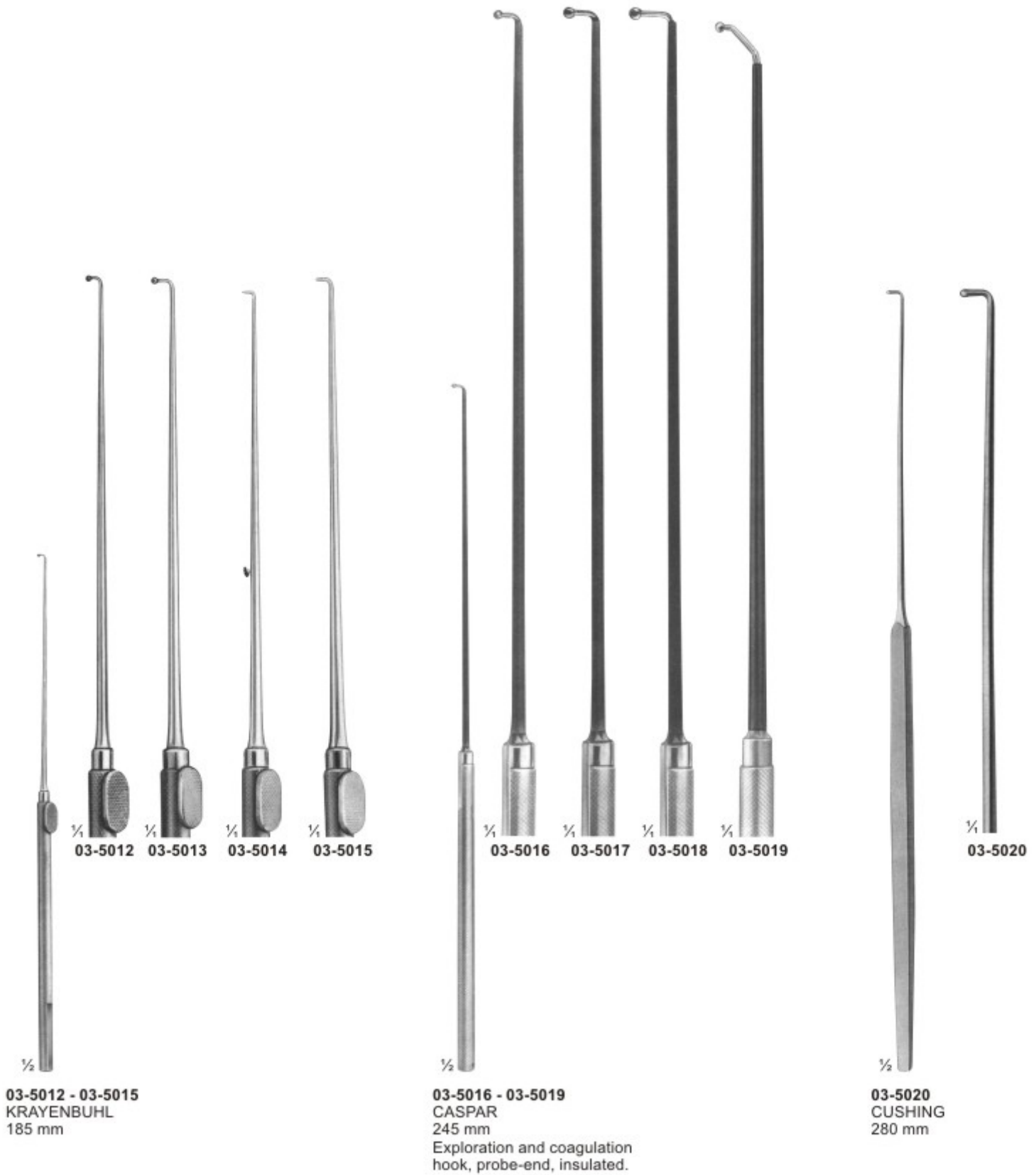

Fine Wound Retractors (Dura- and Skin Retractors)

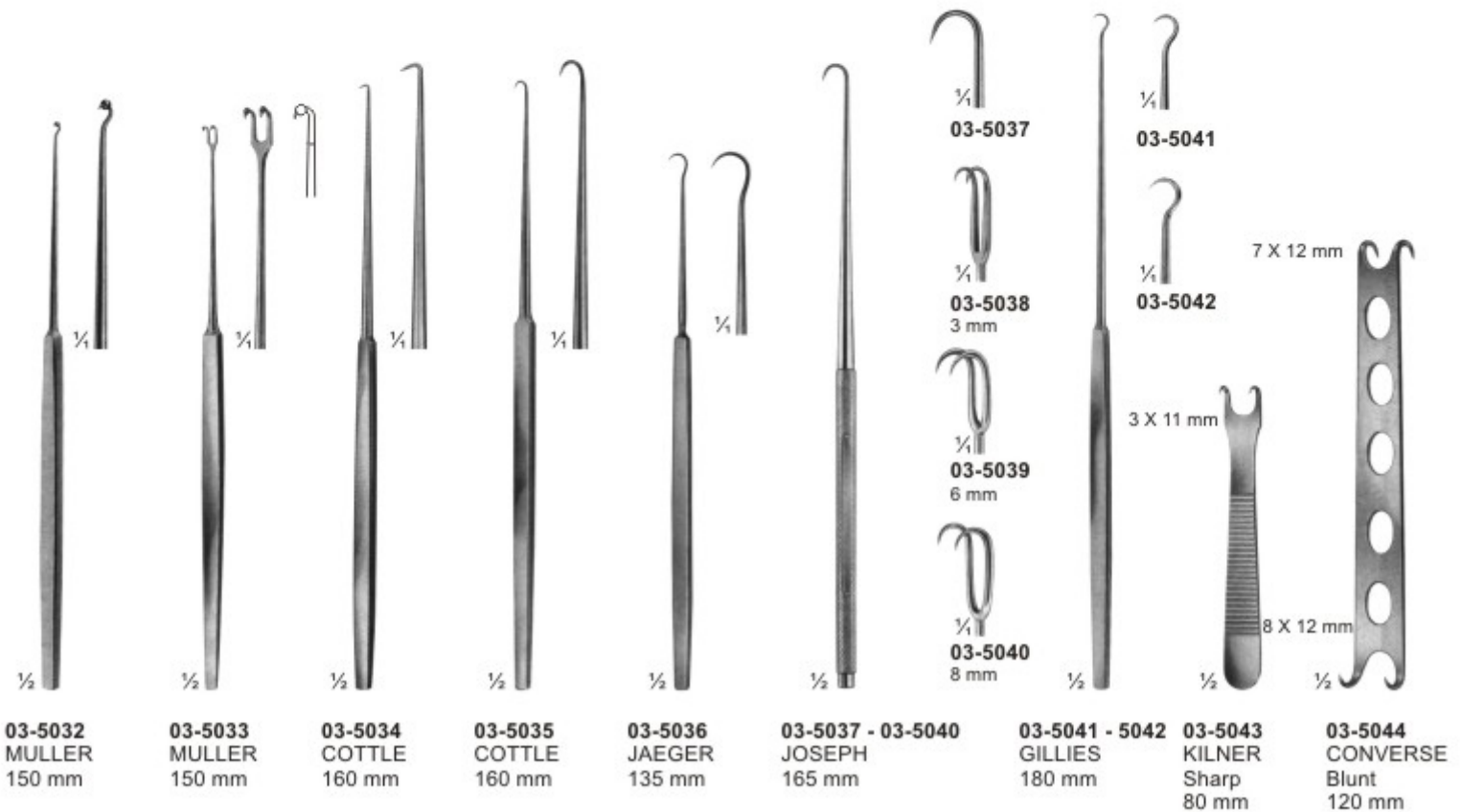
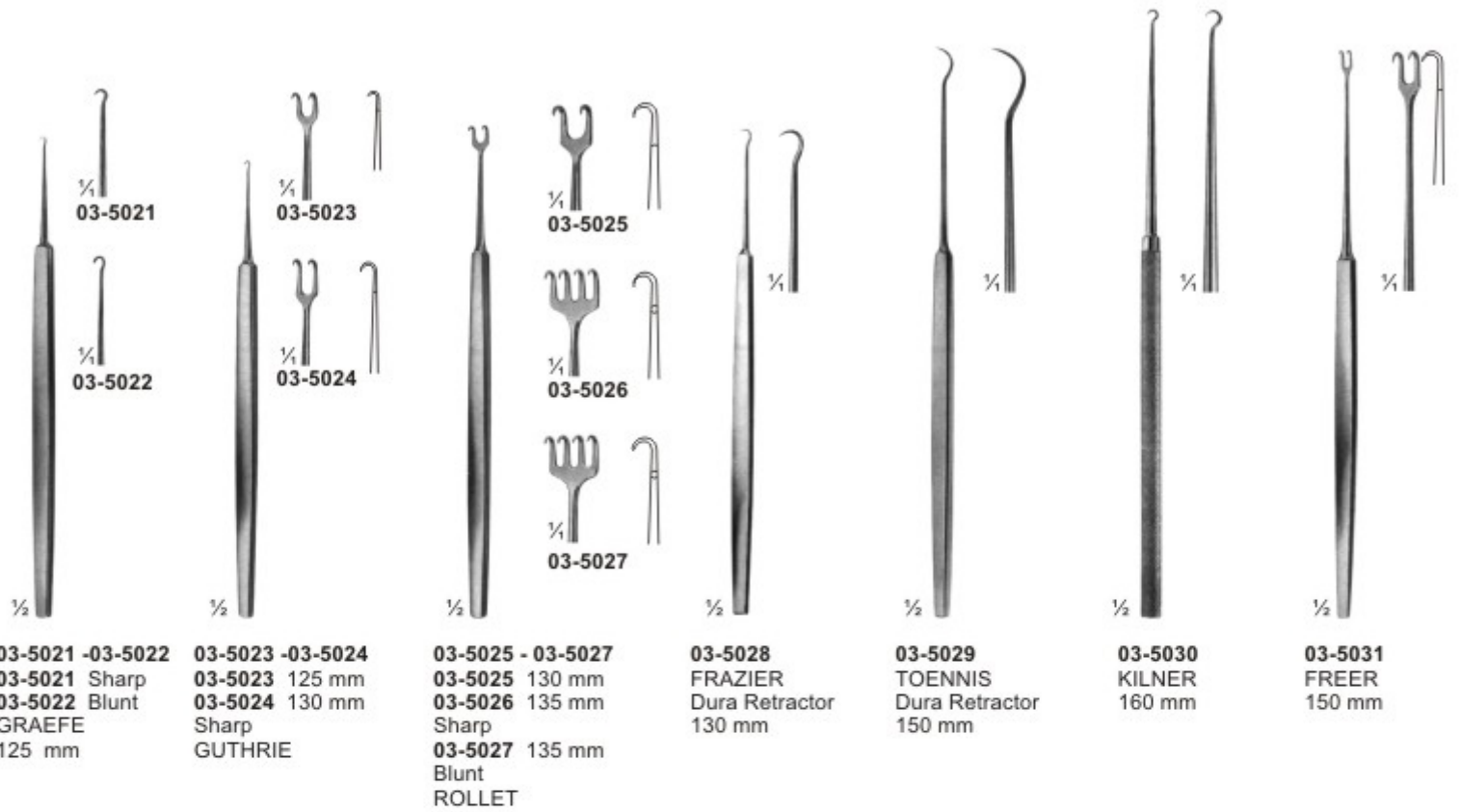

Wound - Trachea Retractors

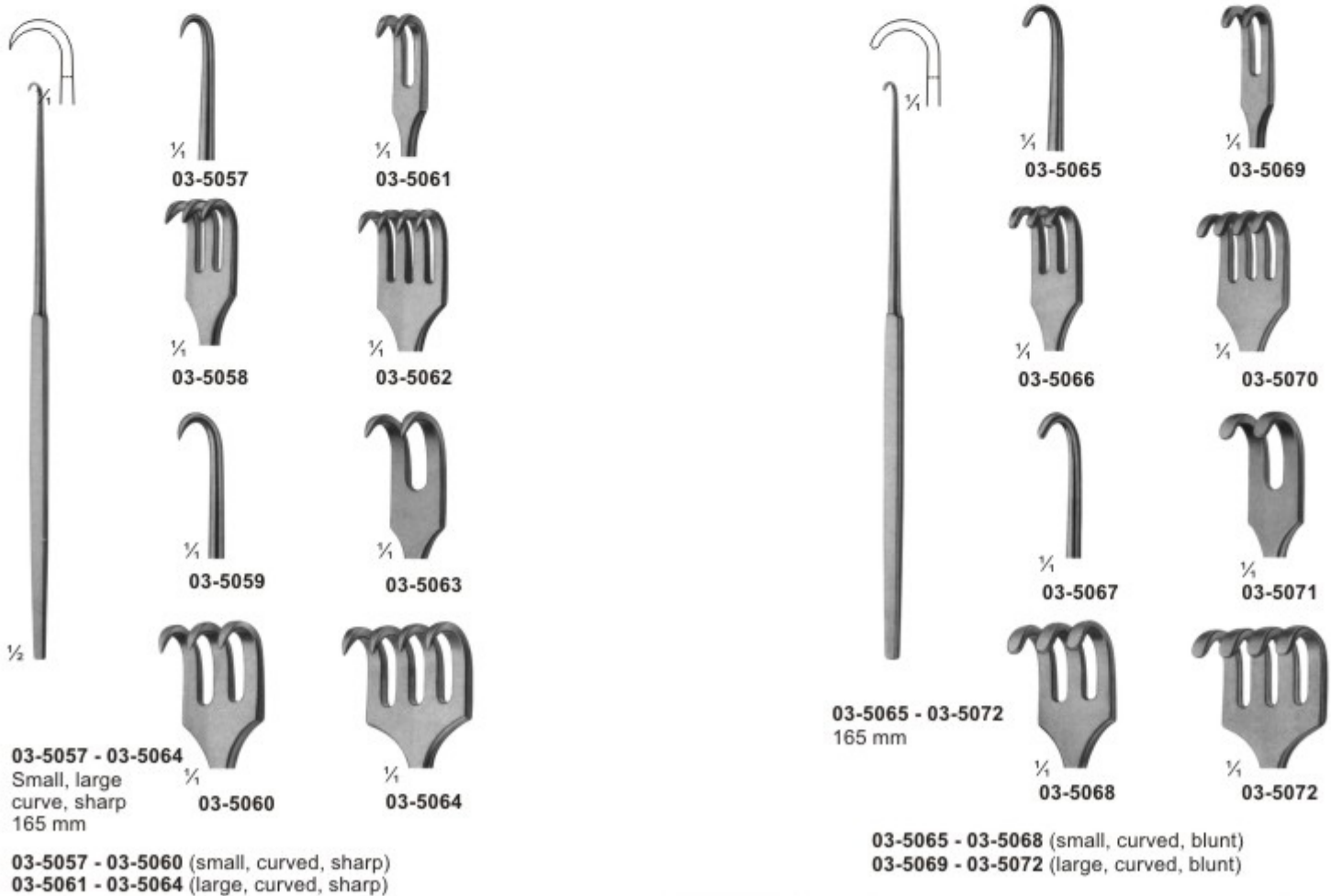

Retractors With Treangle Handle

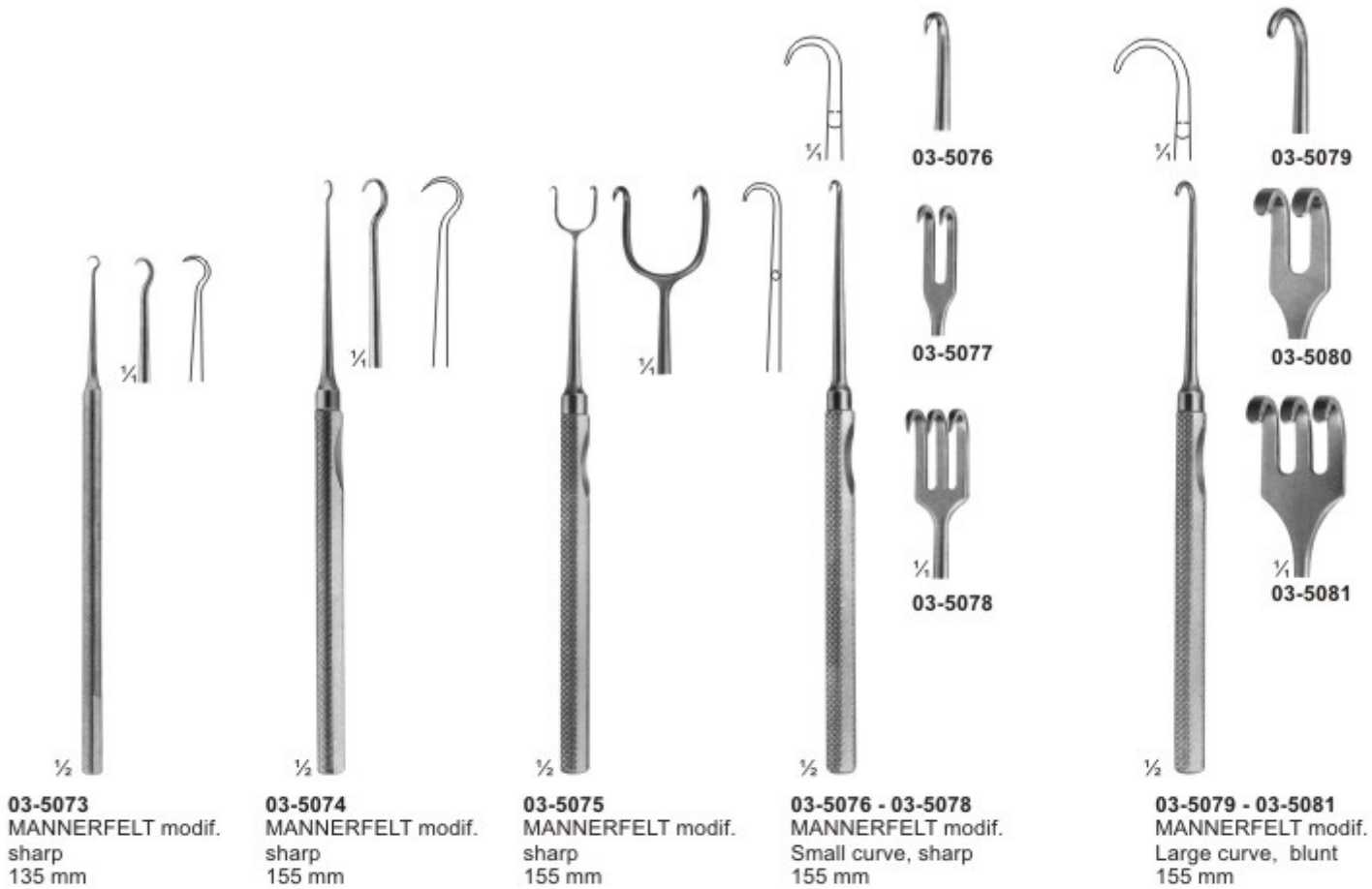

Retractors

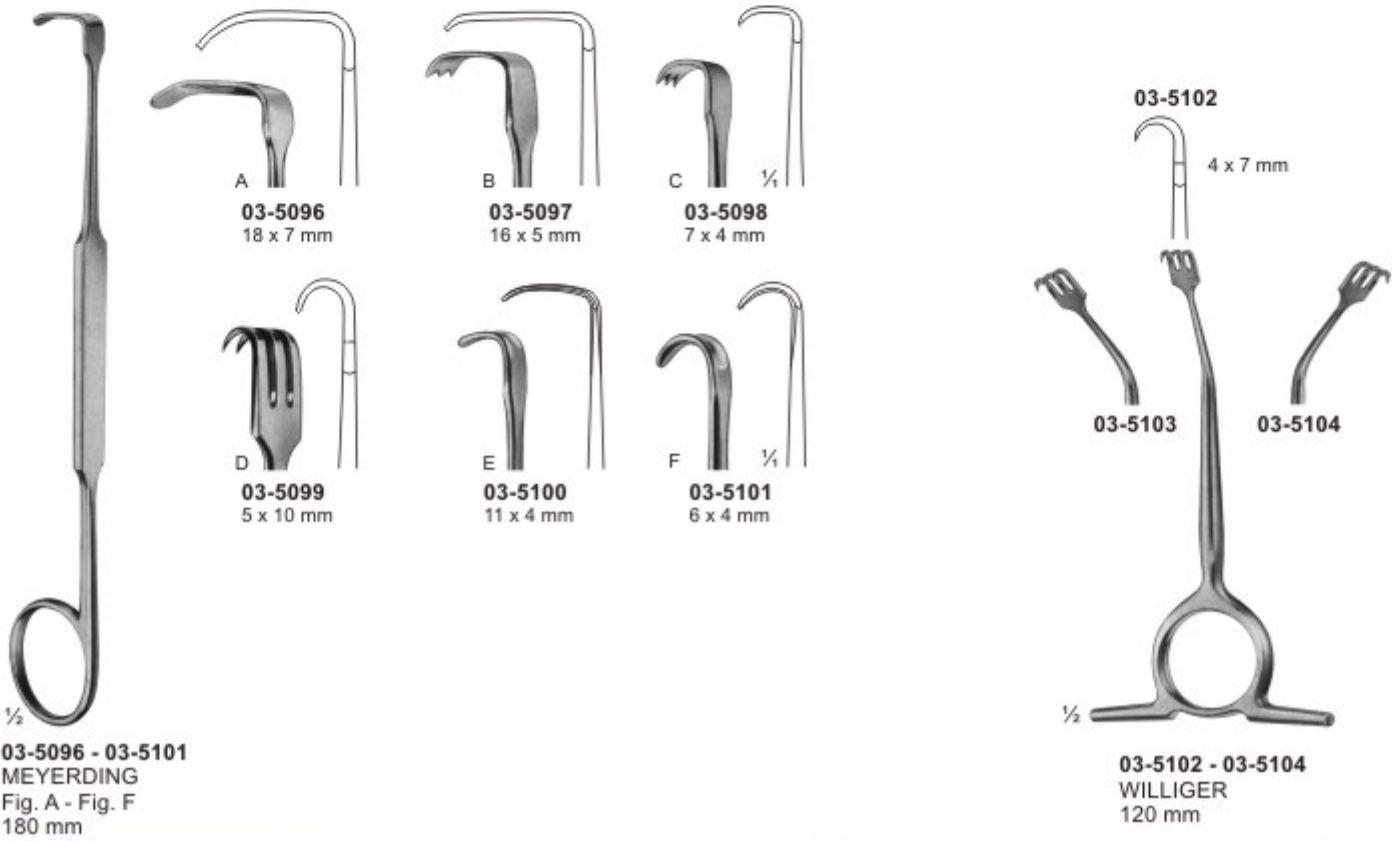

Retractors



03-5105
EMMET
Fistula hook
220 mm



03-5106
SIMON
Fistula hook
220 mm

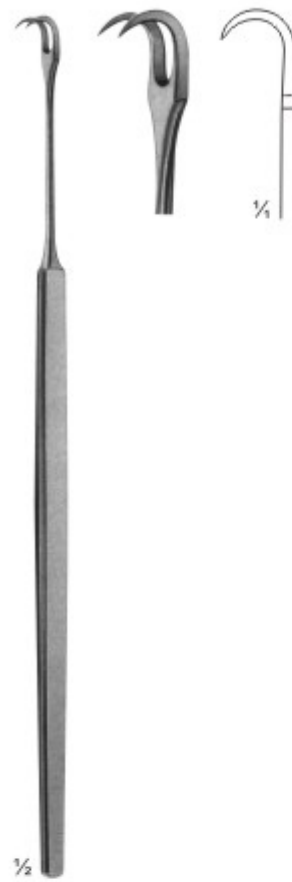

03-5107
SIMON
Fistula hook
220 mm



03-5108
LANGE
Fistula hook
230 mm



03-5109 - 03-5110
Tendon hooks
175 mm

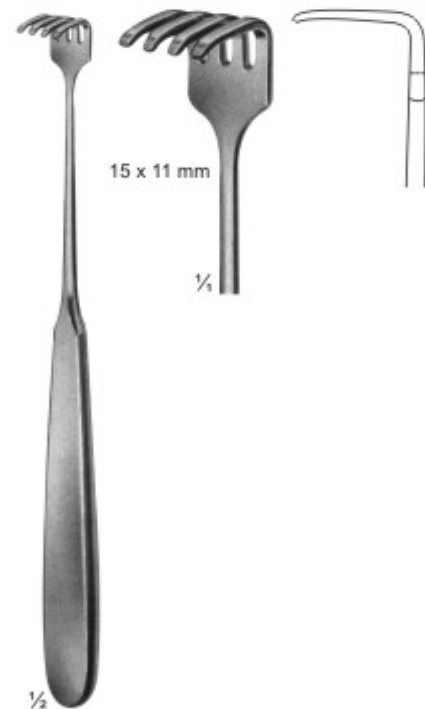

03-5111
KLAPP
Tendon hooks
175 mm

Wound and Vein Retractors

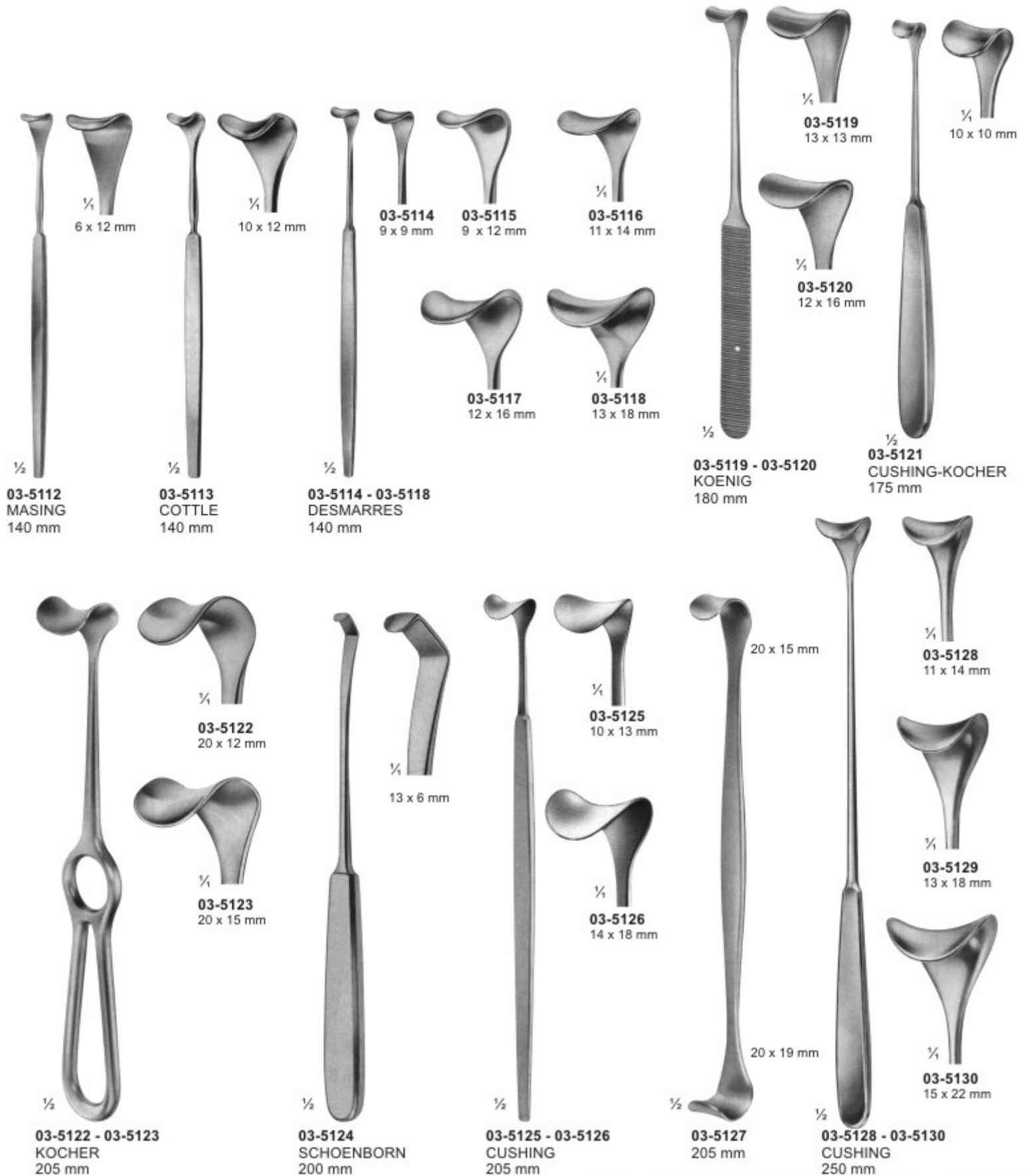

Retractors



03-5131 - 03-5132
BABY-SENN-MILLER
155 mm

03-5133
SENN-MILLER
165 mm

03-5134
COLLIN-HARTMANN
150 mm

03-5135 - 03-5137
STERNBERG
03-5135 120 mm
03-5136 130 mm
03-5137 135 mm

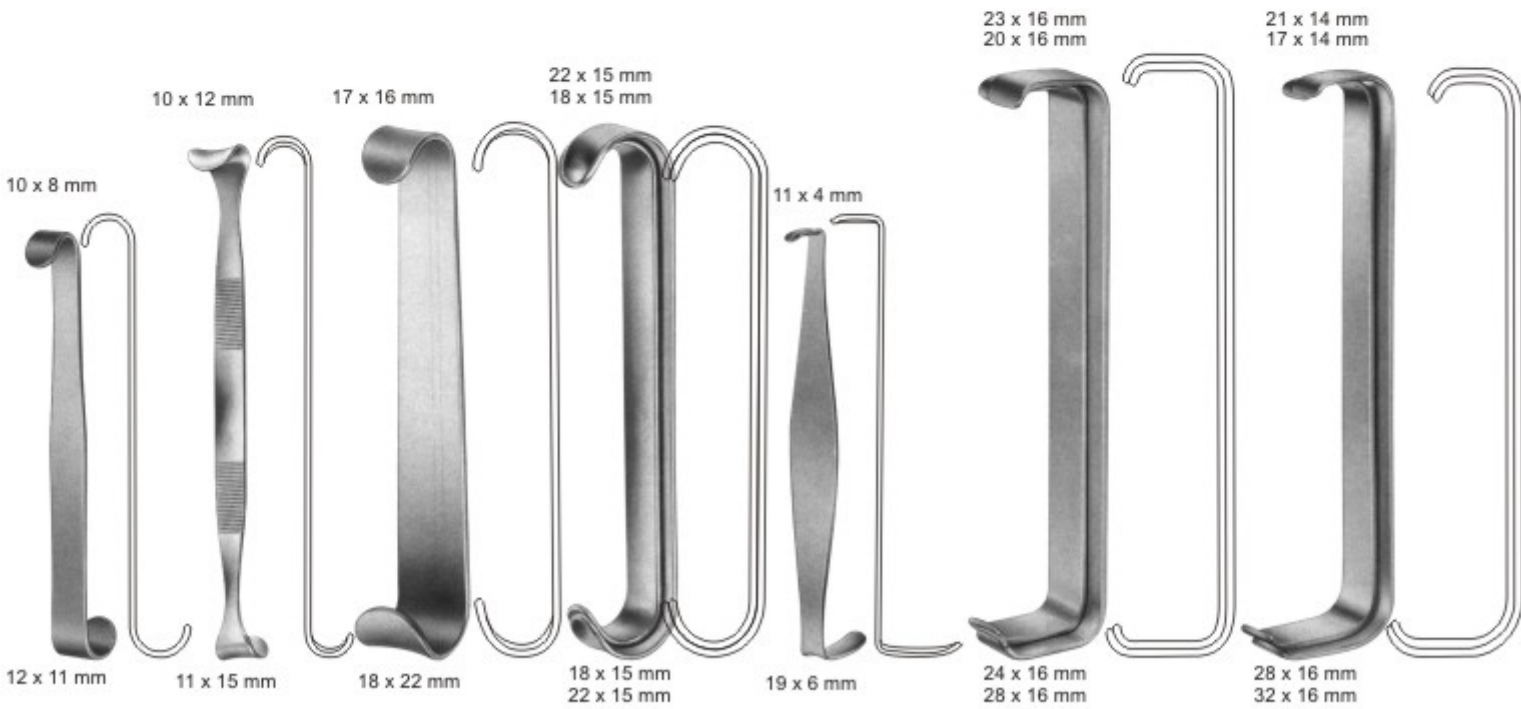

03-5138
LUER
110 mm

03-5139
ROSE
130 mm

03-5140
BABY-ROUX
135 mm

03-5141
PARKER
135 mm

03-5142
CRILE
110 mm

03-5143
FARABEUF
150 mm

03-5144
COLLIN
150 mm

Retractors



Bone Retractors and Retractors



03-5155
KOCHER
Sharp
205 mm



03-5156
KOCHER
Sharp
220 mm



03-5157
VOLKMANN
Sharp
220 mm



03-5158
VOLKMANN
Blunt
220 mm



03-5159
VOLKMANN
Sharp
220 mm



03-5160 - 03-5167
VOLKMANN
225 mm



Sharp

1/4



03-5160
9 x 8 mm



03-5161
9 x 13 mm



03-5162
9 x 19 mm



03-5163
9 x 29 mm



Blunt

1/4



03-5164
8,5 x 8 mm



03-5165
8,5 x 13 mm



03-5166
8,5 x 19 mm



03-5167
8,5 x 29 mm

Retractors

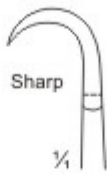

03-5168
9 x 8 mm



03-5169
9 x 13 mm



03-5170
9 x 19 mm



03-5171
9 x 29 mm



03-5172
9 x 40 mm

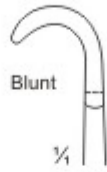

03-5173
8 x 8 mm



03-5174
8 x 13 mm



03-5175
8 x 19 mm



03-5176
8 x 29 mm



03-5177
8 x 40 mm



03-5178
8,5 x 8 mm



03-5179
8,5 x 13 mm



03-5180
8,5 x 19 mm



03-5181
8,5 x 29 mm

03-5168 - 03-5181
VOLKMANN
220 mm

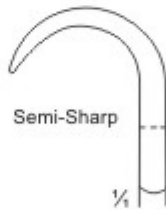

03-5182
16 x 9 mm



03-5183
16 x 14 mm



03-5184
16 x 20 mm



03-5185
16 x 30 mm

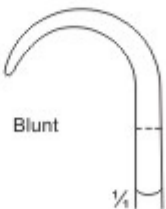

03-5186
15,5 x 9 mm



03-5187
15,5 x 14 mm



03-5188
15,5 x 20 mm



03-5189
15,5 x 30 mm

03-5182 - 03-5189
KOCHER
220 mm

Retractors, Deep form



26 x 40 mm

03-5190
8 Prongs, blunt



26,5 x 40 mm

03-5191
8 Prongs, sharp

½

03-5190 - 03-5191
KOERTE
Handle vertical
to the blade.
240 mm



½

03-5192 - 03-5195
ISRAEL
255 mm

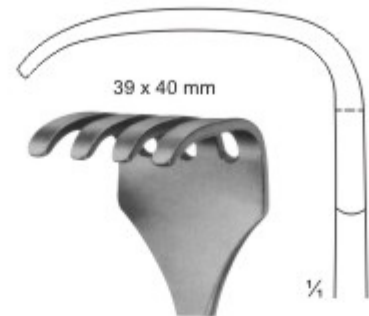

39 x 40 mm

¼

03-5192
4 Prongs, blunt

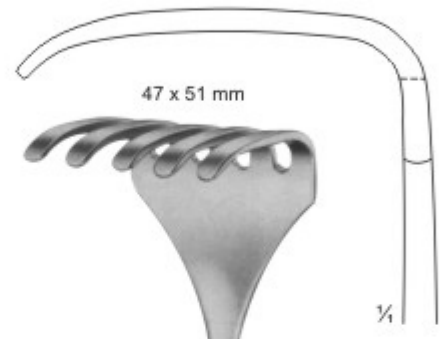

47 x 51 mm

¼

03-5193
5 Prongs, blunt

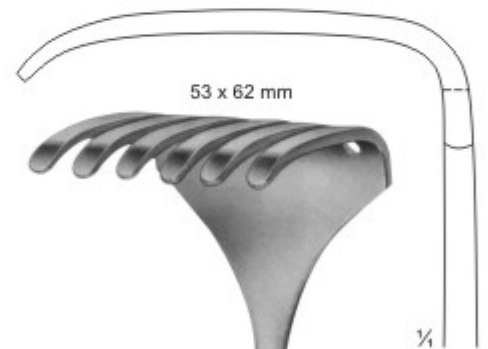

53 x 62 mm

¼

03-5194
6 Prongs, blunt

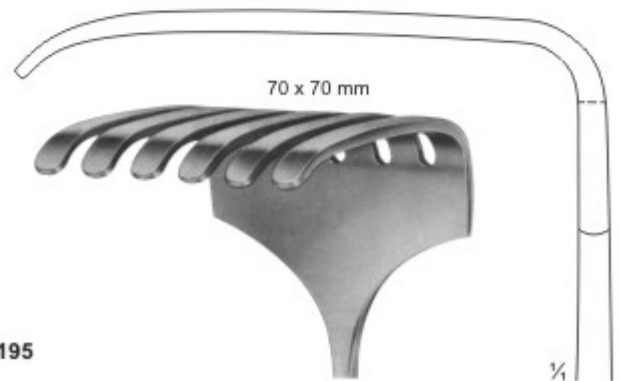

70 x 70 mm

¼

03-5195
6 Prongs, blunt

Retractors



03-5196 - 03-5201
LANGENBECK
210 mm

03-5196	28 x 10 mm
03-5197	28 x 14 mm
03-5198	33 x 14 mm
03-5199	28 x 16 mm
03-5200	40 x 10 mm
03-5201	40 x 13 mm



03-5202 - 03-5210
KOCHER-LANGENBECK
215 mm

03-5202	25 x 6 mm
03-5203	35 x 8 mm
03-5204	35 x 11 mm
03-5205	35 x 15 mm
03-5206	41 x 11 mm
03-5207	55 x 11 mm
03-5208	70 x 14 mm
03-5209	80 x 12mm
03-5210	80 x 16mm



03-5211
LANGENBECK
215 mm

Retractors



½

03-5212 - 03-5216
KOCHER
230 mm



½

03-5217 - 03-5219
SAUERBRUCH
225 mm

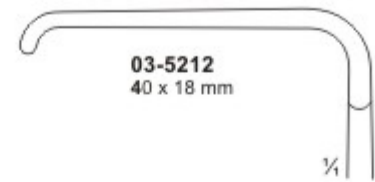

03-5212
40 x 18 mm

¼

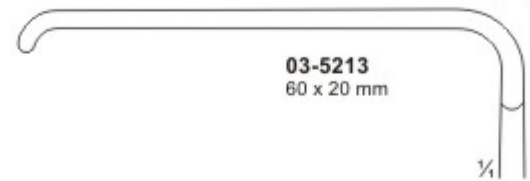

03-5213
60 x 20 mm

¼

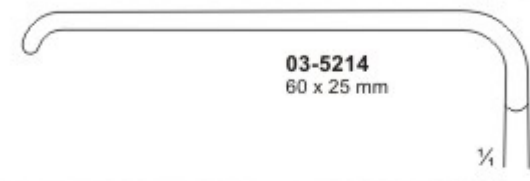

03-5214
60 x 25 mm

¼



03-5215
75 x 30 mm

¼



03-5216
75 x 40 mm

¼

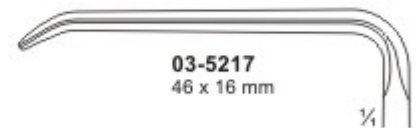

03-5217
46 x 16 mm

¼

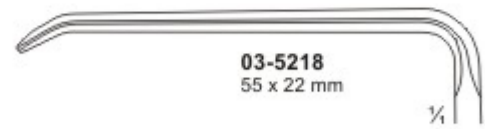

03-5218
55 x 22 mm

¼



03-5219
72 x 19 mm

¼

Retractors

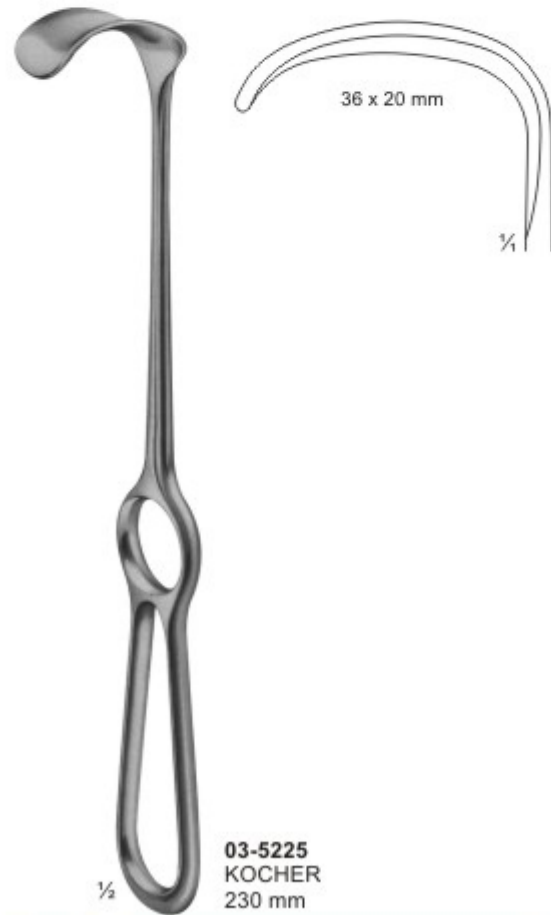
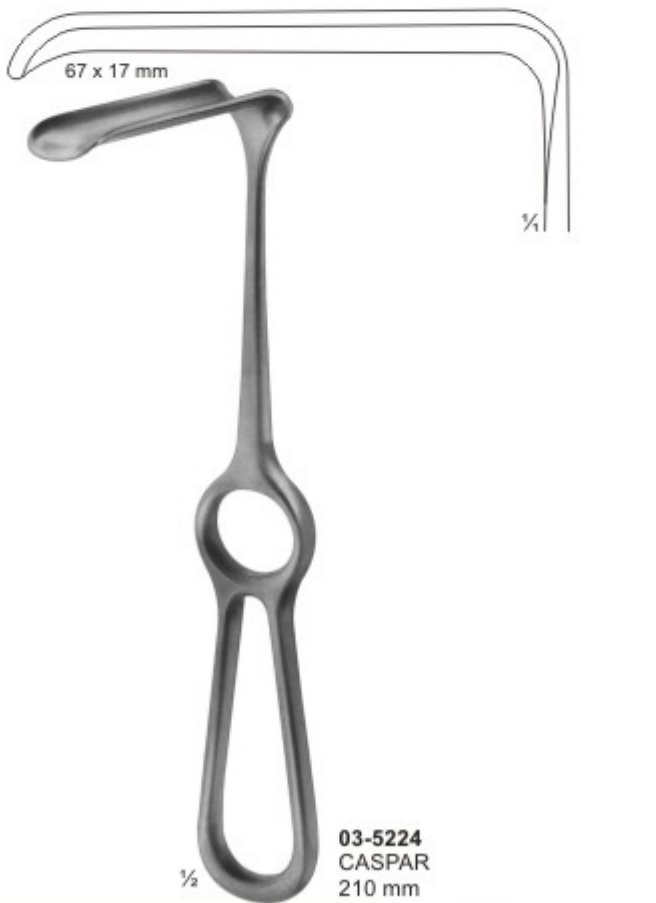
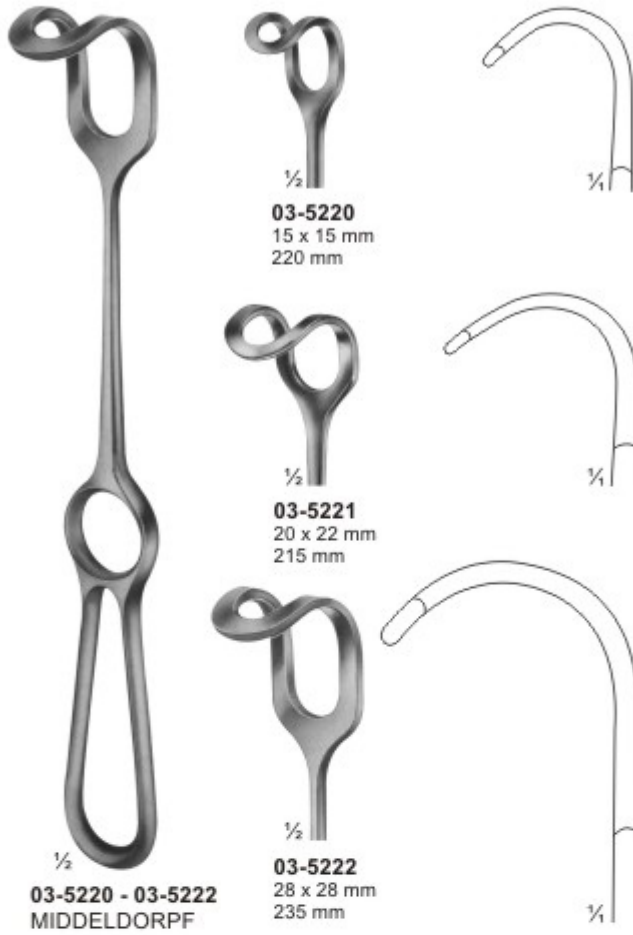

Retractors



1/2

03-5226 - 03-5231
HOSEL
250 mm



03-5226
60 x 20 mm

1/4



03-5227
80 x 30 mm

1/4

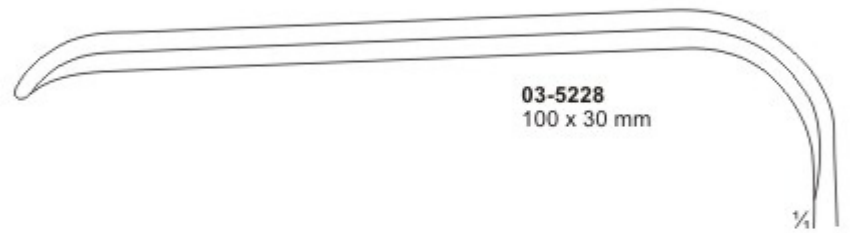

03-5228
100 x 30 mm

1/4

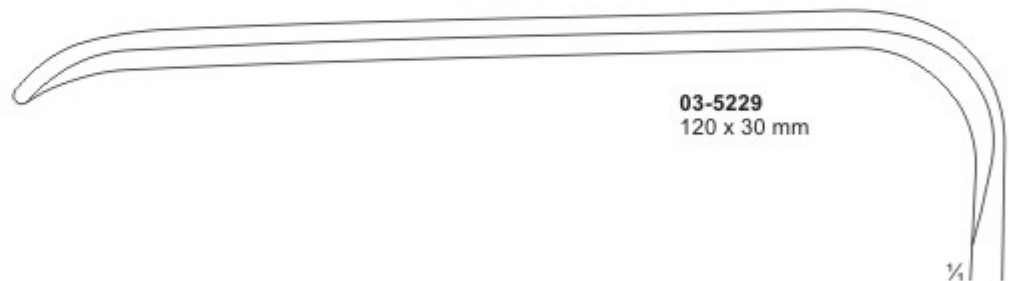

03-5229
120 x 30 mm

1/4

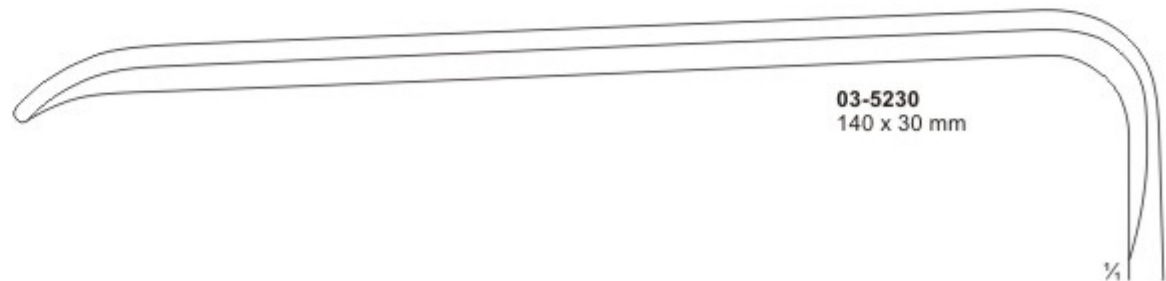

03-5230
140 x 30 mm

1/4

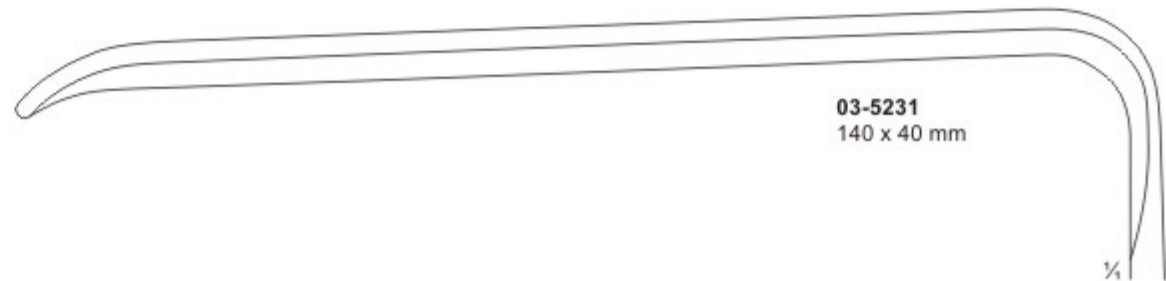

03-5231
140 x 40 mm

1/4

Retractors



Retractors

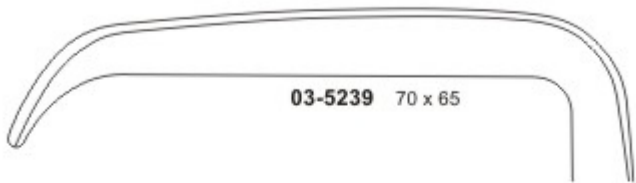

03-5239 - 03-5240
KELLY
260 mm



03-5241 - 03-5242
MORRIS
245 mm

Retractors For Deep Surgery



Retractors, Vario Retractor System, Germ. Fed Patent, Germ. Fed. Regd.Des, US-Patent.

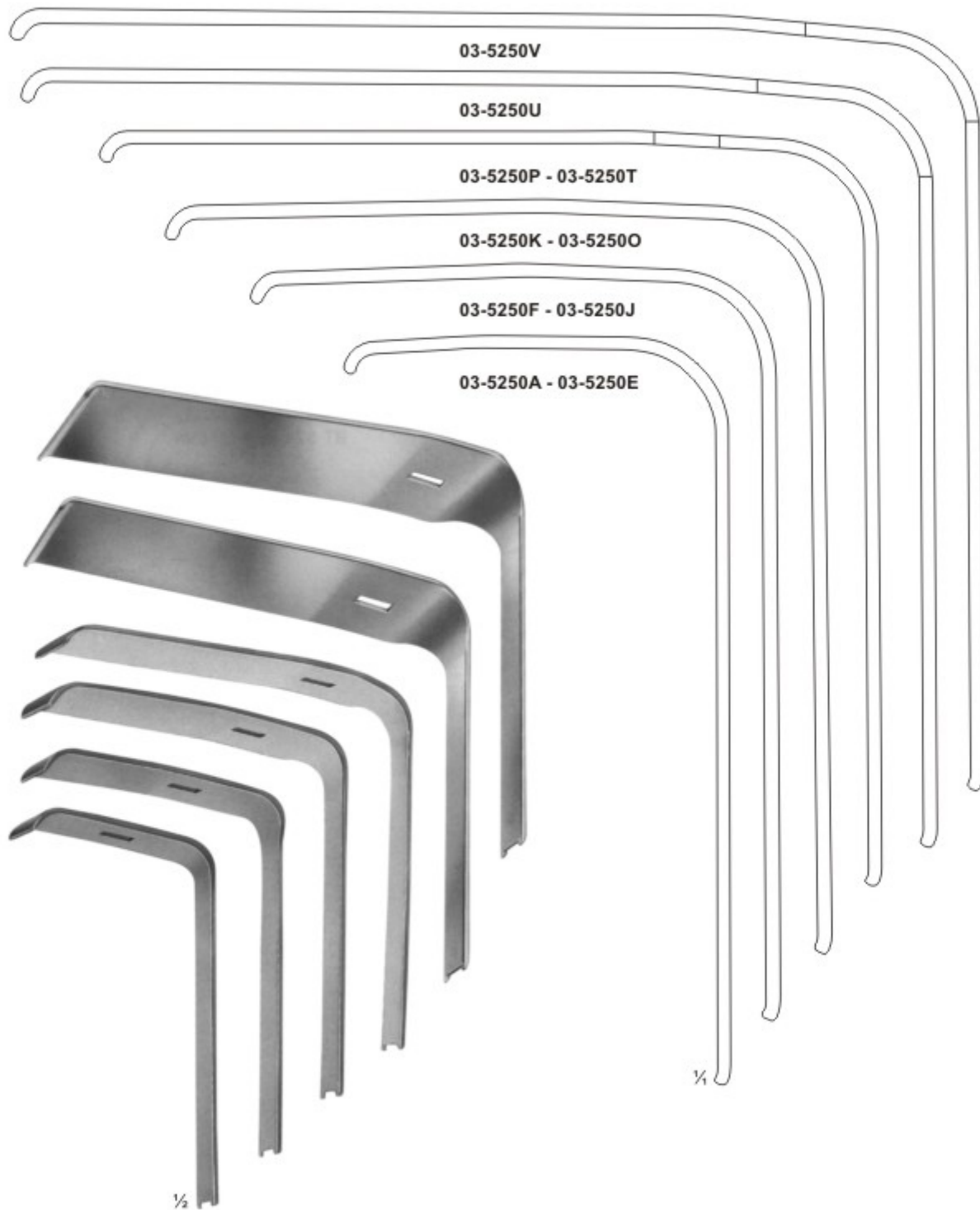

Retractor blades for handles **03-5250**

Depth	Width						
	14mm	18mm	22mm	26mm	30mm	40mm	50mm
55mm	03-5250A	03-5250B	03-5250C	03-5250D	03-5250E	-	-
75mm	03-5250F	03-5250G	03-5250H	03-5250I	03-5250J	-	-
95mm	03-5250K	03-5250L	03-5250M	03-5250N	03-5250O	-	-
115mm	03-5250P	03-5250Q	03-5250R	03-5250S	03-5250T	-	-
135mm	-	-	-	-	-	03-5250U	-
145mm	-	-	-	-	-	-	-03-5250V

Retractors, Vario Retractor System, Germ. Fed. Patent, Germ. Fed. Regd.Des, US-Patent.

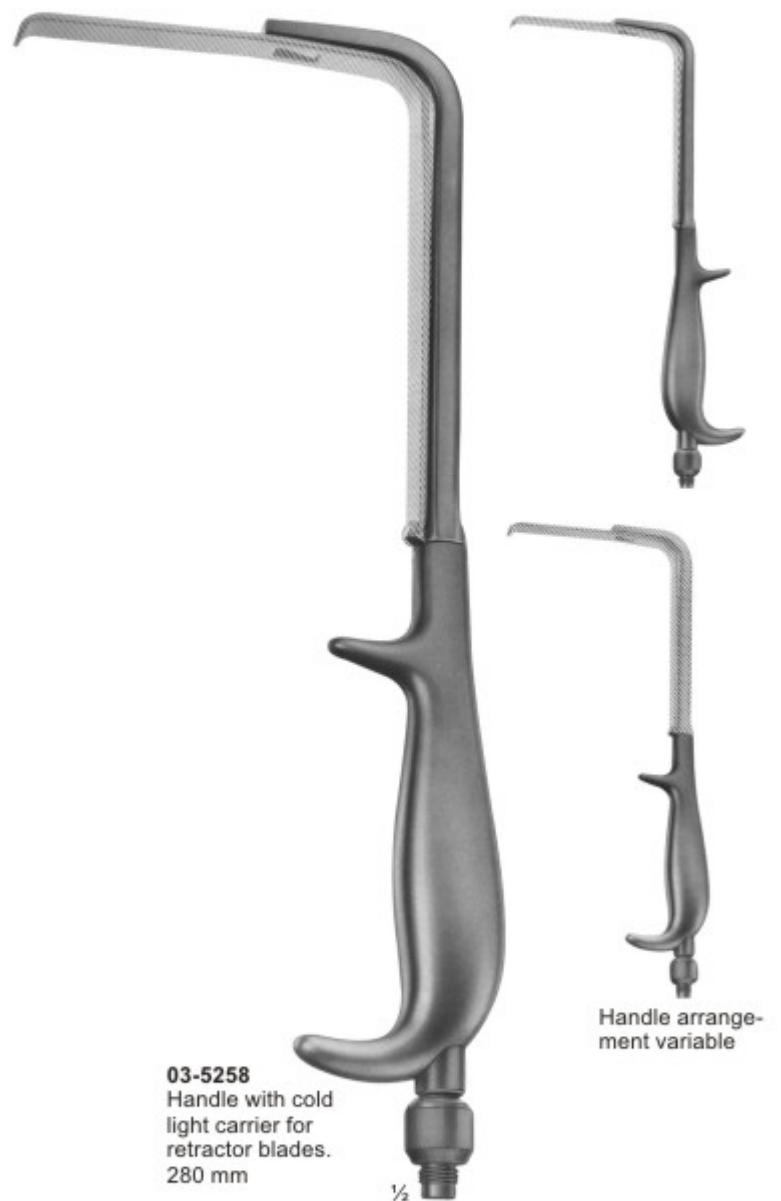

Retractors, Lung Spatulas

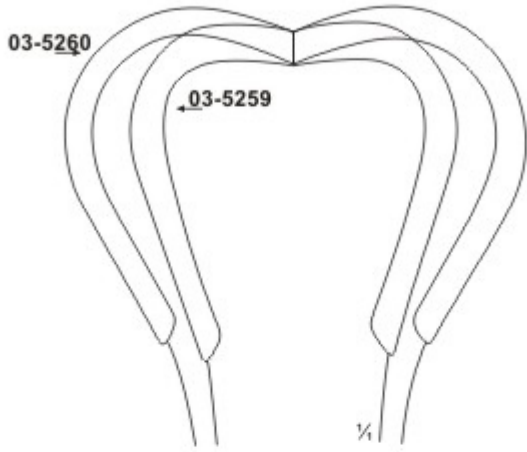

03-5259 - 03-5260
HARRINGTON
03-5259 123 x 45 mm
03-5260 123 x 64 mm
Flexible
295 mm



03-5261
ALLISON
255 mm



03-5262
ALLISON
320 mm

Retractors, Lung Spatulas



Retractors, Lung Spatulas



03-5271
DEAVER
300 mm
Fig. 1



03-5272
DEAVER
315 mm
Fig. 2



03-5273
DEAVER
365 mm
Fig. 2 1/4

Retractors, Lung Spatulas



03-5274
DEAVER
300 mm
Fig. 3

03-5275
DEAVER
310 mm
Fig. 4

03-5276
DEAVER
320 mm
Fig. 5

Retractors, Lung Spatulas



03-5277
DEAVER
310 mm
Fig. 1



03-5278
DEAVER
310 mm
Fig. 3

Retractors, Lung Spatulas



03-5279
DEAVER
305 mm
Fig. 4



03-5280
DEAVER
310 mm
Fig. 5

Retractors For Deep Surgery (Abdominal Retractors)

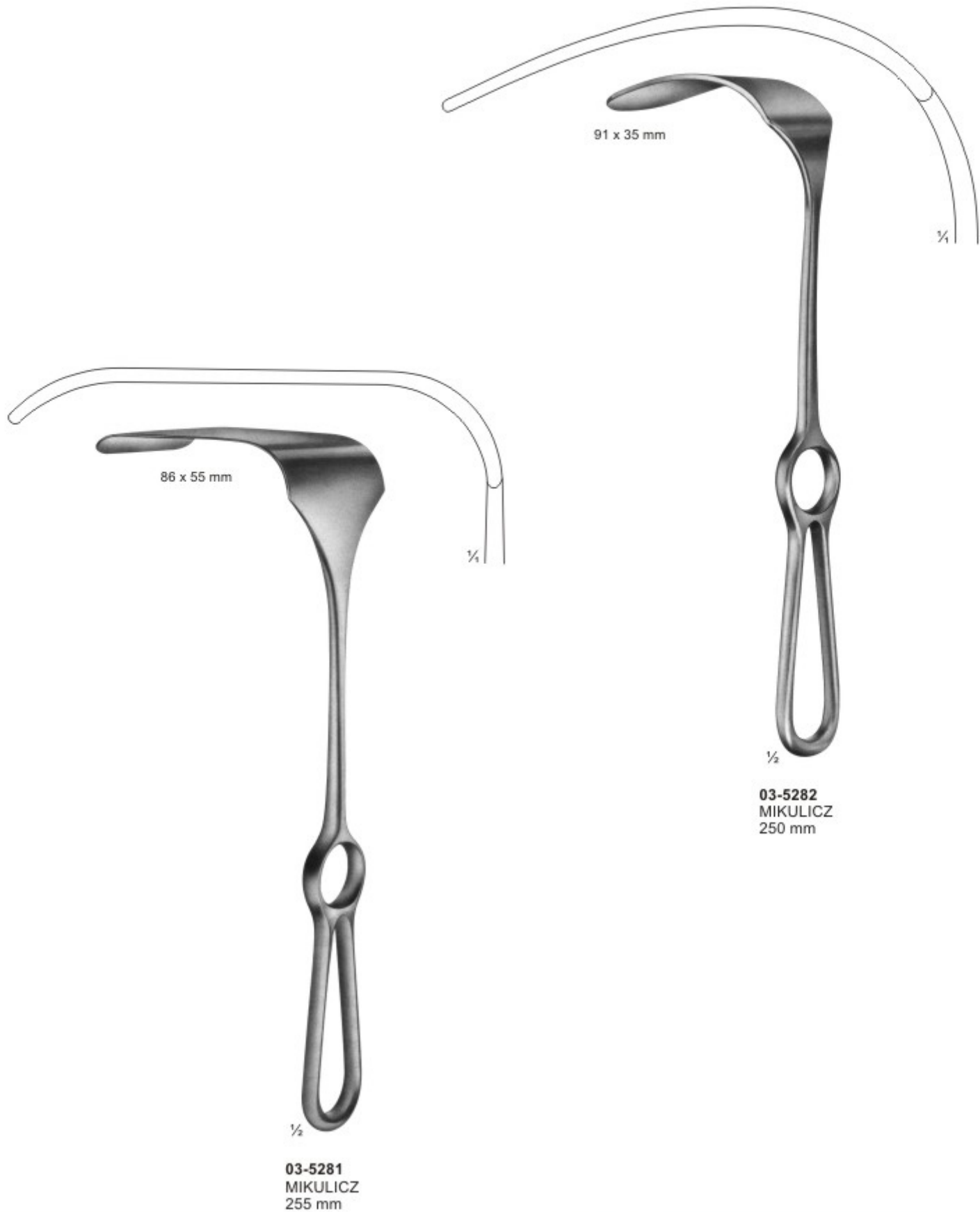

Retractors For Deep Surgery (Abdominal Retractors)

03-5285 150 x 39 mm
03-5286 150 x 57 mm

03-5283 121 x 50 mm
03-5284 147 x 50 mm

03-5285 - 03-5286
KELLY
03-5285 150 x 39 mm
03-5286 150 x 57 mm
260 mm

03-5283 - 03-5284
MIKULICZ
03-5283 121 x 50 mm
03-5284 147 x 50 mm
Liver Retractor
250 mm

Retractors, Abdominal Retractors



Length of Blades	Width of Blades		
	35mm	45mm	60mm
62mm	03-5287	03-5290	03-5294
92mm	03-5288	03-5291	03-5295
122mm	03-5289	03-5292	03-5296
160mm		03-5293	03-5297

Abdominal Retractors



03-5304 - 03-5308
ROCHARD
310 mm
03-5304 48 x 90 mm
03-5305 48 x 105 mm
03-5306 48 x 120 mm
03-5307 48 x 135 mm
03-5308 48 x 155 mm



03-5309
ROCHARD
Fixation device for



03-5310 - 03-5313
DOYEN
280 mm
03-5310 48 x 90 mm
03-5311 48 x 105 mm
03-5312 48 x 120 mm
03-5313 48 x 135 mm



03-5314
DOYEN-CHILD
Fixation device
220 mm



03-5315
Chain
with weight
645g
790 mm

Pelvis Retractors

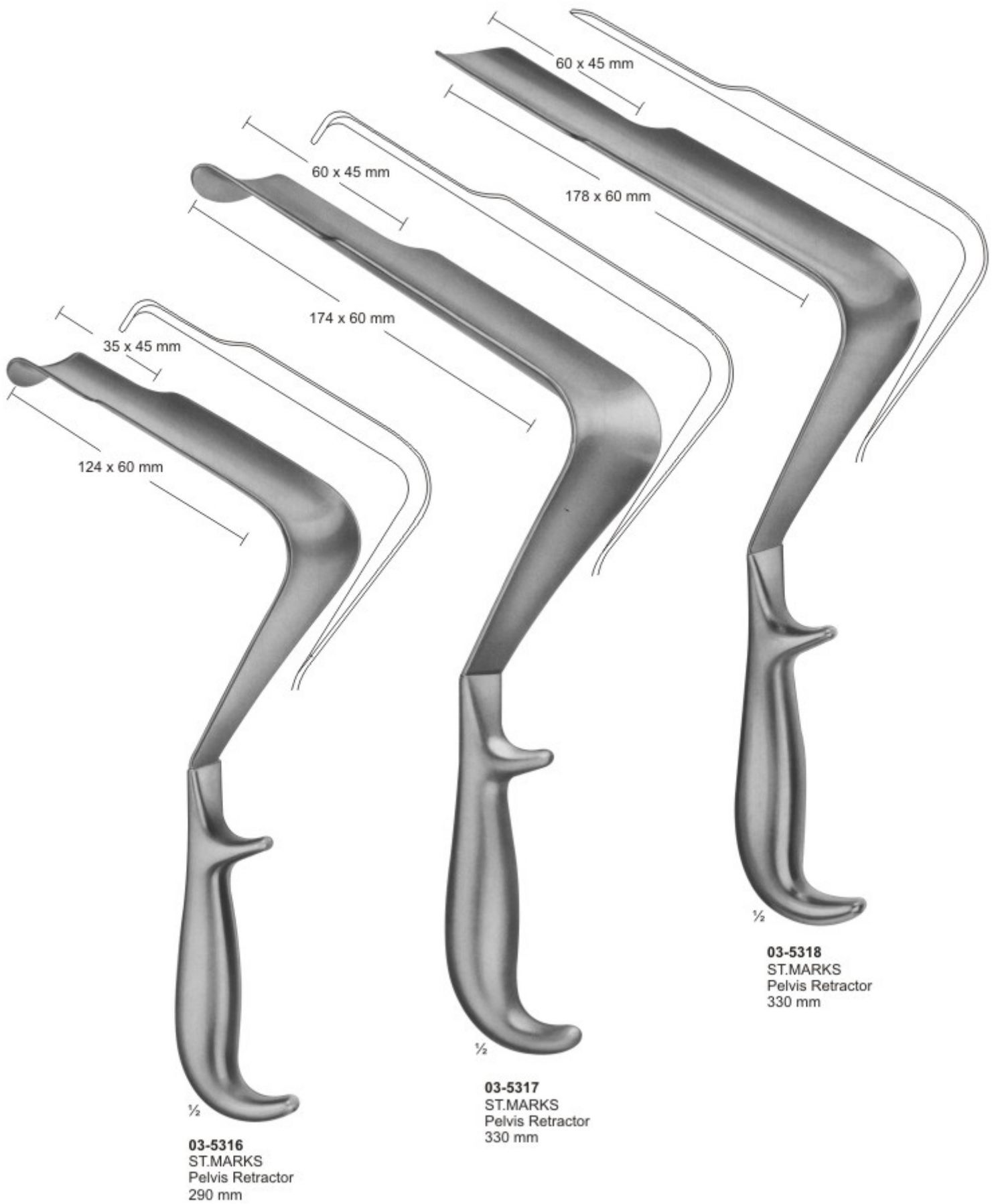

Abdominal- and Intestinal Spatulas

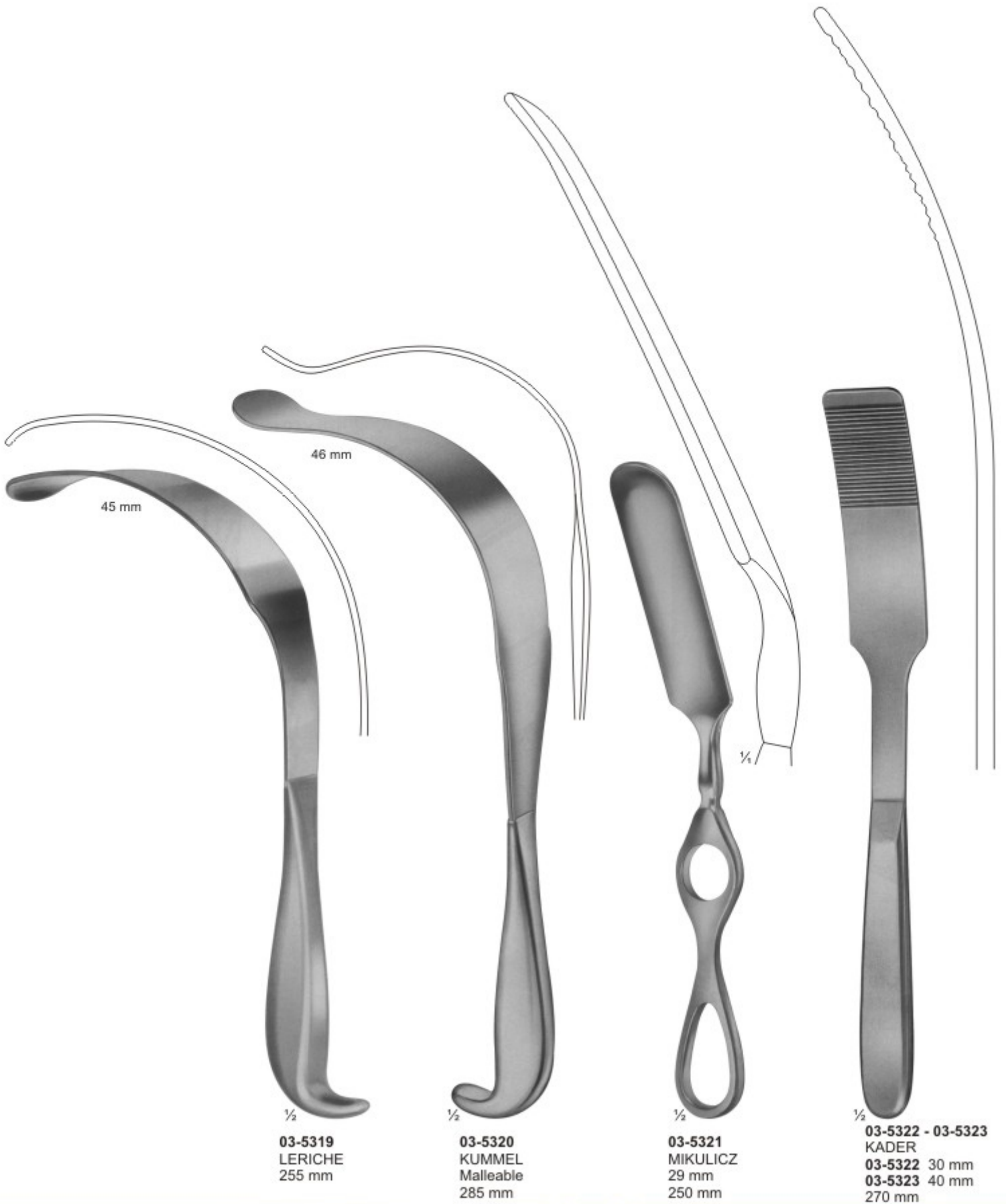

Abdominal- and Intestinal Spatulas



03-5324
REVERDIN
285 mm



03-5325
HABERER
Malleable
305 mm



03-5326 - 03-5328
03-5326 30 mm
03-5327 40 mm
03-5328 50 mm
Malleable
330 mm



03-5329
TUFFIER
Malleable
200 mm

Self-Retaining Retractors



03-5330
BOSE
60 mm



03-5331
FINSEN
50 mm



03-5332
FINSEN
70 mm



03-5333
FINSEN modif.
75 mm



03-5334
45 mm



03-5335
55 mm



03-5336
MUELLER
65 mm



03-5337
100 mm



03-5338 **03-5339**



03-5338 - 03-5339
03-5338 70 mm
03-5339 100 mm



03-5340
LOGAN
modif. REILL
50 mm



03-5341
JANSEN
100 mm



03-5342
JANSEN
100 mm



03-5343
BARRAQUER
45 mm

Self-Retaining Retractors



03-5344
WEITLANER
Sharp
110 mm



03-5345
WEITLANER
Semi-Sharp
110 mm



03-5346
WEITLANER
Blunt
110 mm



03-5347
WEITLANER
Sharp
130 mm



03-5348
WEITLANER
Semi-Sharp
130 mm



03-5349
WEITLANER
Blunt
130 mm

Self-Retaining Retractors



03-5350
WEITLANER
Sharp
130 mm

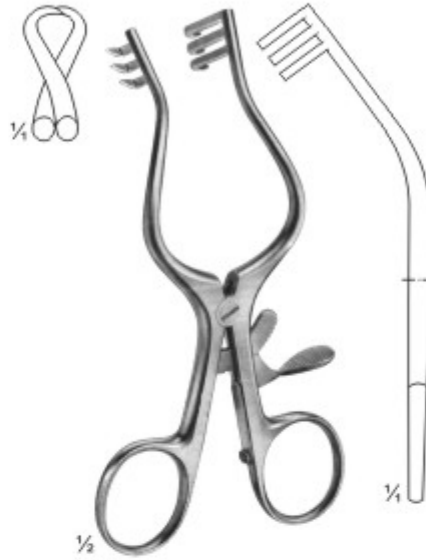

03-5351
WULLSTEIN
Sharp
130 mm

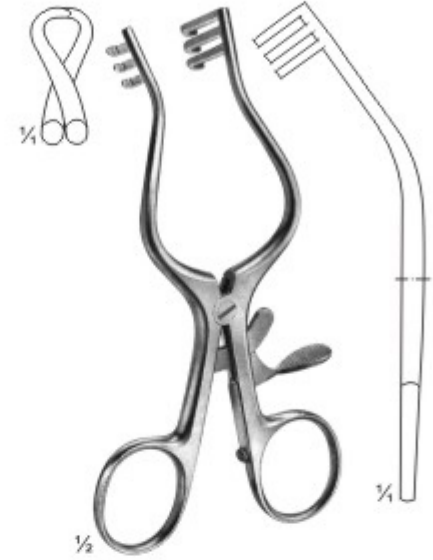

03-5352
WULLSTEIN
Blunt
130 mm



03-5353
WEITLANER
Sharp
165 mm



03-5354
PLESLER
Blunt
110 mm



03-5355
PERKINS
130 mm

Self-Retaining Retractors



03-5356
ADSON-BABY
Blunt
140 mm

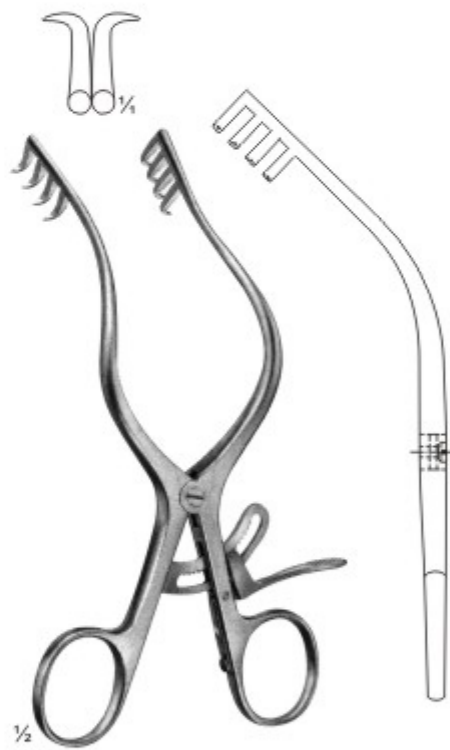

03-5357
MOLLISON
Sharp
155 mm



03-5358
MAYO-ADAMS
165 mm

Self-Retaining Laminectomy Retractors

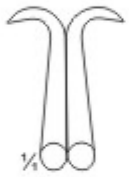

03-5359
ANDERSON-ADSON
Sharp
190 mm



03-5360
NORFOLK and
NORWICH
Blunt
220 mm



03-5361
ADSON
Sharp
265 mm

Self-Retaining Laminectomy Retractors



Sharp



Semi-Sharp



Semi-Sharp

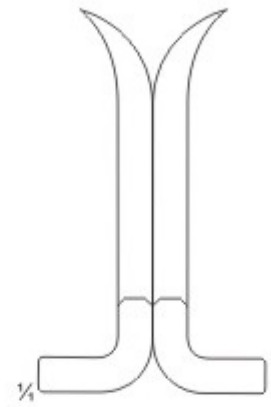

Sharp

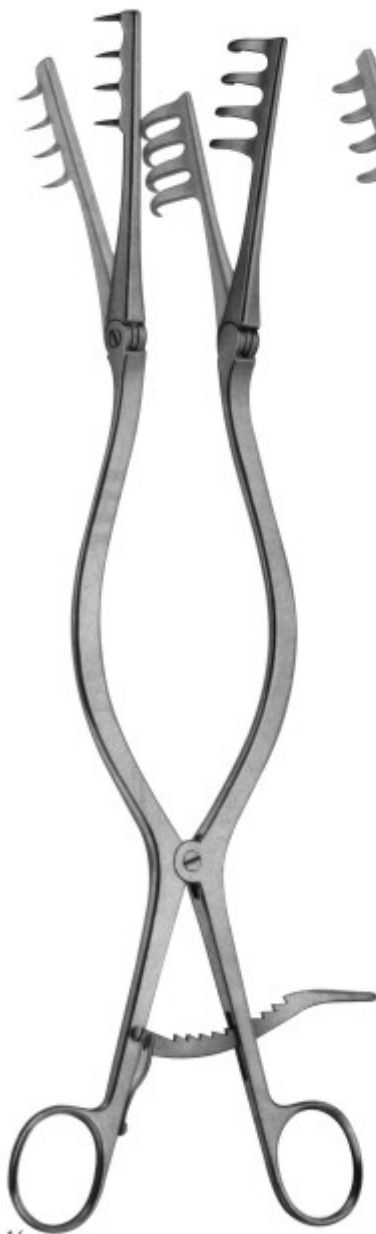

1/2

03-5362 - 03-5363
BECKMANN-ADSON
Sharp
310 mm



03-5363
BECKMANN-ADSON
Semi-Sharp
310 mm



1/2

03-5364
ADSON
Semi-Sharp
320 mm



1/2

03-5365
BECKMANN-EATON
Sharp
320 mm

Special Retractors



1/2

03-5366
JOLL (FRIEDMAN)
Thyroid- and Vaginal Retractor
155 mm

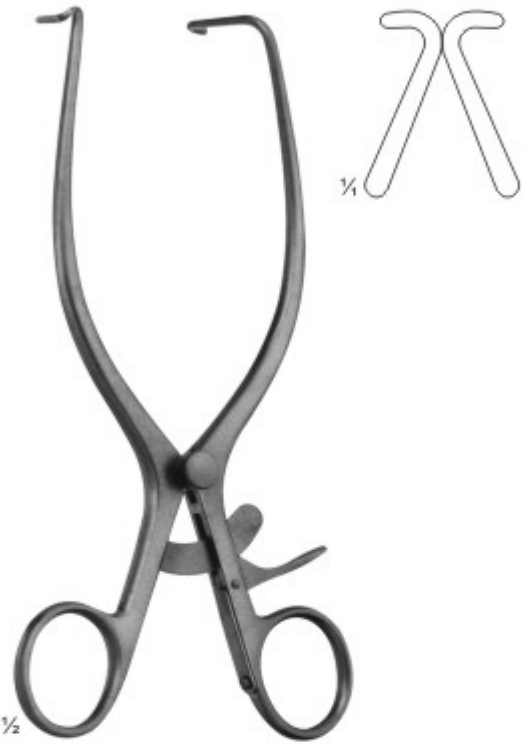

1/2

03-5367
JACKSON BURROWS
Retractor, blunt
185 mm

1/4



1/4



1/2

03-5368
GELPI
Vaginal Retractor
135 mm

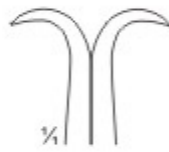

1/4



1/2

03-5369
GELPI
Skin- and Vaginal Retractor
175 mm

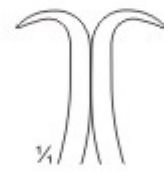

1/4



1/2

03-5370
DE BAKEY
Femur Retractor
145 mm

Self Retaining Retractors for Laminectomy and other Operations

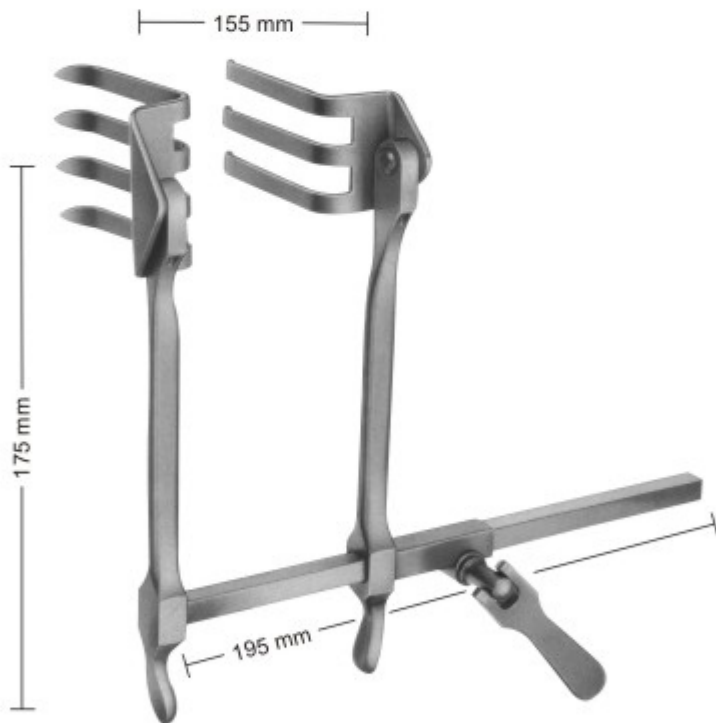

03-5371
SCOVILLE-RICHTER
 Retractor with 1 pair blades reversible type.
 The Retractor bar and shanks may be easily rotated 180° when blades are in situ.



03-5372
 62 x 52 mm
 PR= Pair

62 x 37 mm



03-5373
 47 x 51 mm



03-5374
 30 x 40 mm



03-5375
 37 x 62 mm

Retractors for Cervical Spine



03-5376
CLOWARD modif.
Spreader Only
Consisting of:
Spreader Only
03-5377 1 Blade
03-5378 1 Blade
03-5379 1 Blade
03-5380 1 Blade
03-5381 1 Blade

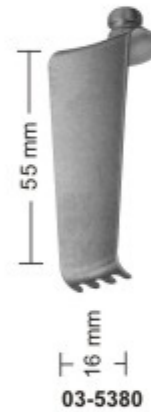

Blades only used for **03-5375**

Retractors for Cervical Vertebral Column

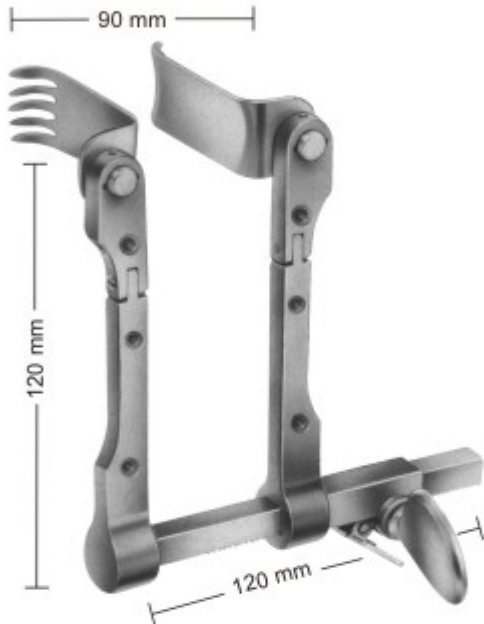

03-5387
CASPAR
Retractor, adjustable, consisting of:
5 medial blades (03-5389 - 03-5393) 5 Lateral
blades. (03-5394 - 03-5398) and the retractor
only By Reversing the Screw,
The Retractor Can be Used From Both Sides

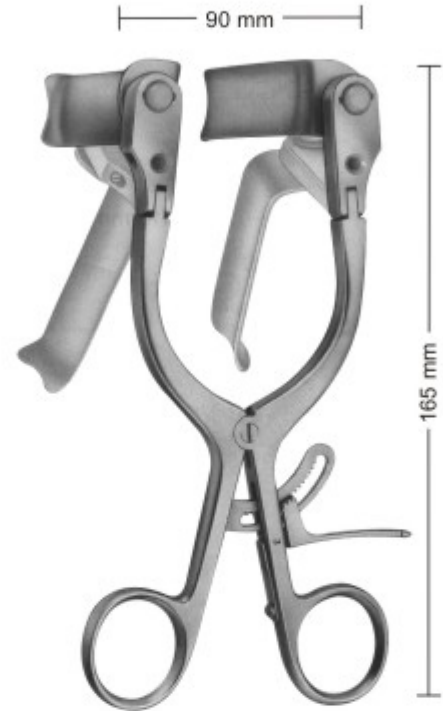

03-5388
CASPAR
Counter retractor, adjustable,
consisting of: 5 blades. (03-5399 - 03-5403)
and the retractor only

To be used preferably for transverse retraction.

To be used preferably for up and down retraction.



03-5389 40 x 23 mm
03-5390 45 x 23 mm
03-5391 50 x 23 mm
03-5392 55 x 23 mm
03-5393 60 x 23 mm
Medial blades

03-5394 40 x 23 mm
03-5395 45 x 23 mm
03-5396 50 x 23 mm
03-5397 55 x 23 mm
03-5398 60 x 23 mm
Lateral blades

03-5399 45 x 23 mm
03-5400 50 x 23 mm
03-5401 55 x 23 mm
03-5402 60 x 23 mm
03-5403 65 x 23 mm
Blunt blades

03-5404 50 x 25 mm
03-5405 60 x 25 mm
Blunt blades,
for harvesting of the
fusion graft from the
iliac crest

03-5406 40 x 25 mm
03-5407 45 x 25 mm
03-5408 50 x 25 mm
03-5409 55 x 25 mm
03-5410 60 x 25 mm
Medial Titan blades
semi transparent to x-ray

03-5411 40 x 25 mm
03-5412 45 x 25 mm
03-5413 50 x 25 mm
03-5414 55 x 25 mm
03-5415 60 x 25 mm
Lateral Titan blades
semi transparent to x-ray

Lamina Spreaders



03-5416
CLOWARD
155 mm



03-5417
CLOWARD
135 mm

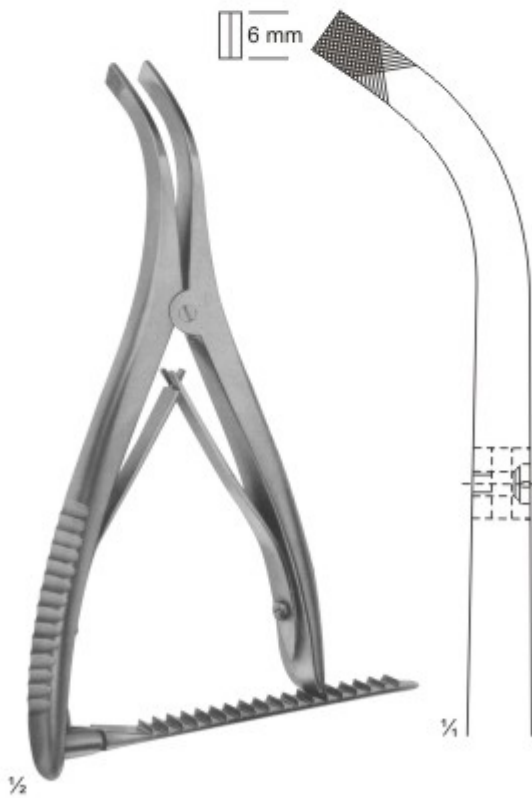

03-5418
INGE
170 mm

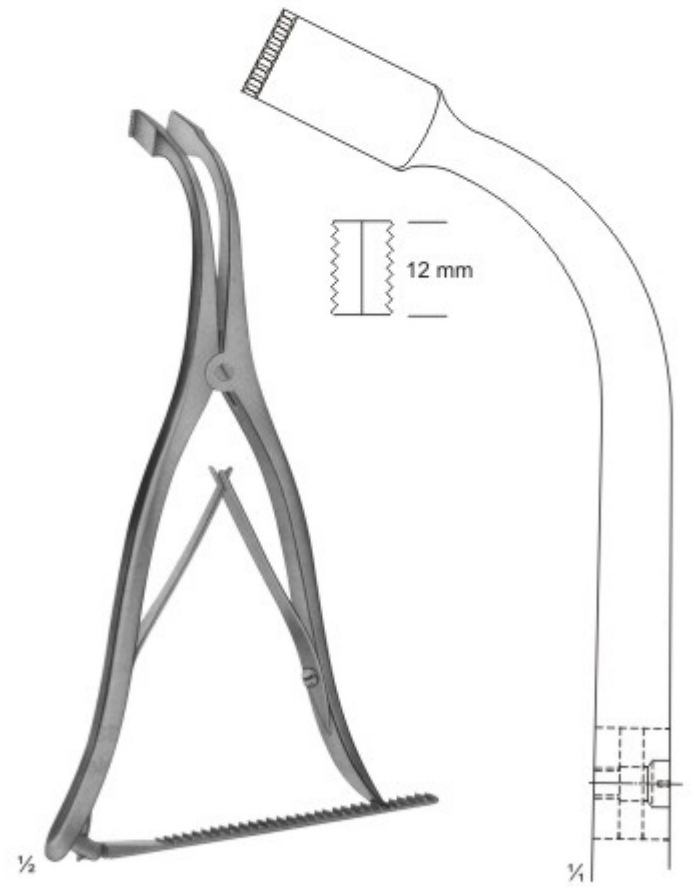

03-5419
INGE
275 mm

Abdominal Retractors

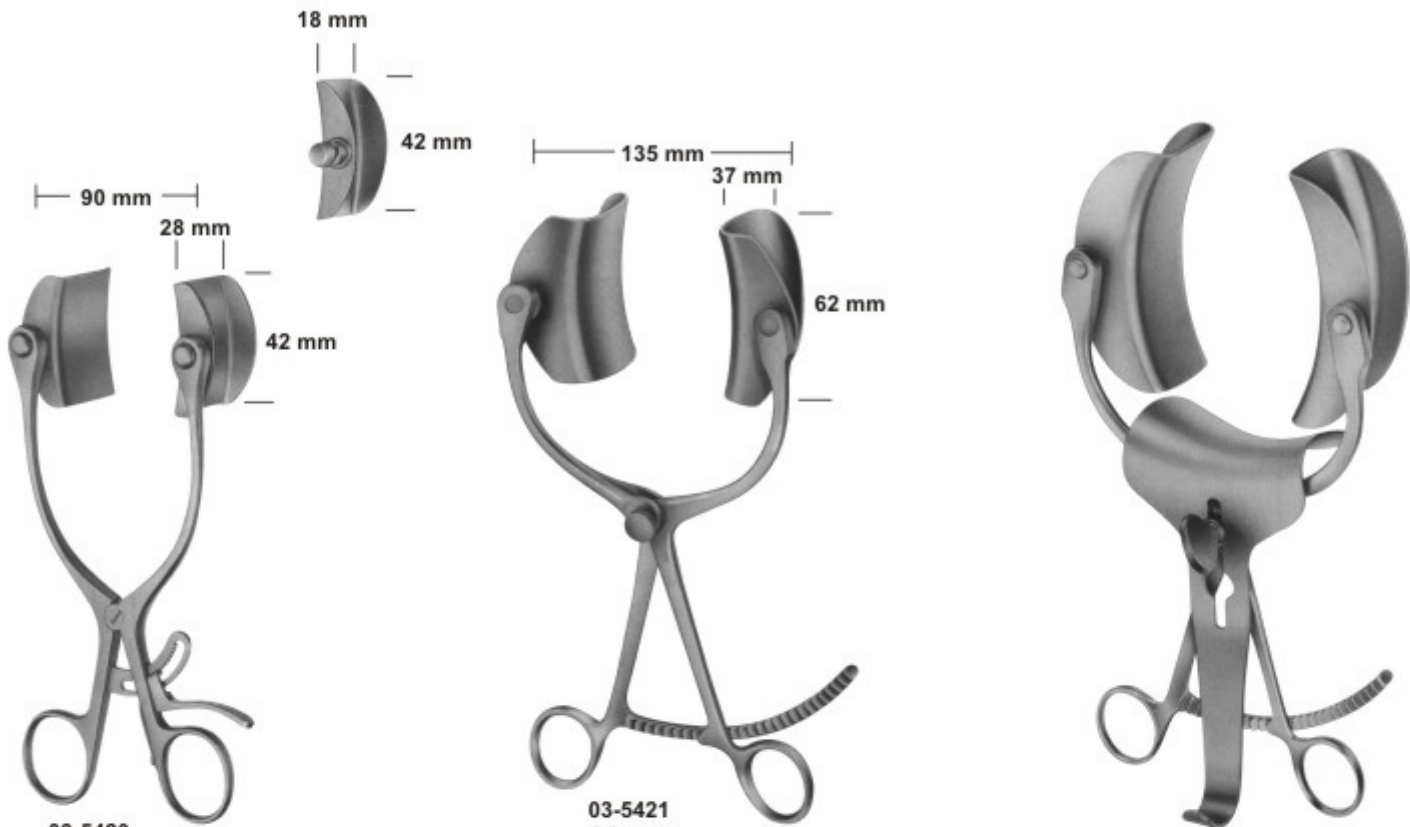

03-5420
BABY-COLLIN
with 2 pair of blades

03-5421
COLLIN
complete

03-5422
COLLIN
complete



03-5423
RICARD
complete
Spreader only
Lateral blade
Center blade



03-5424
HOLZBACH
Complete
Spreader only
Lateral blade 59x80mm
Center blade 74x82mm

Abdominal Baldes



Lateral blades only
 03-5425 37x62 mm
 03-5426 37x80 mm
 03-5427 37x98 mm



03-5428 61x80 mm

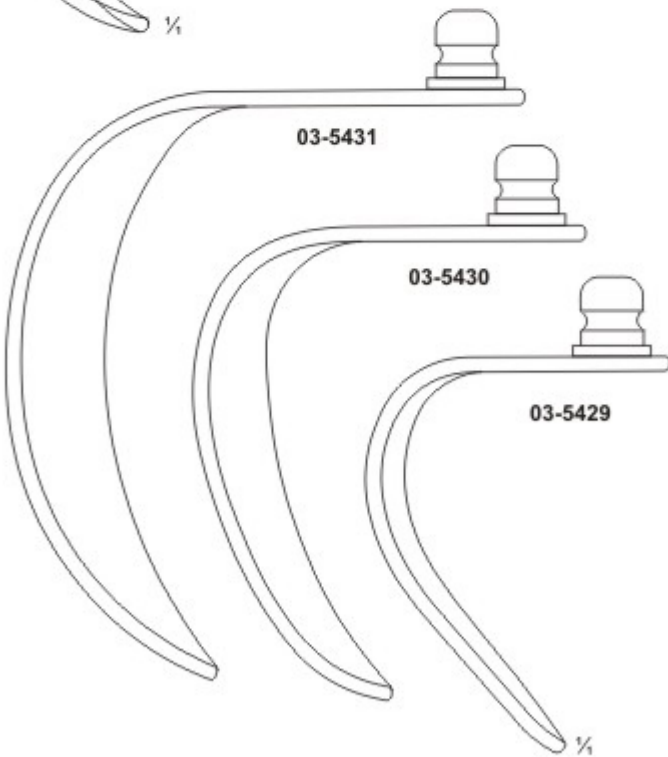

03-5429 48x59 mm
 03-5430 58x80 mm
 03-5431 72x84 mm



Abdominal Retractors



03-5433
GOSSET
Blades: 38 mm deep

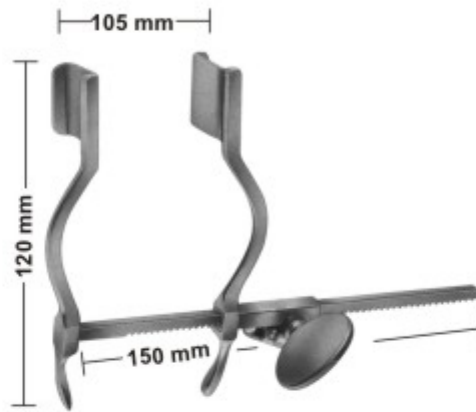

03-5434
HERTZLER
Blades 20 X 25 mm

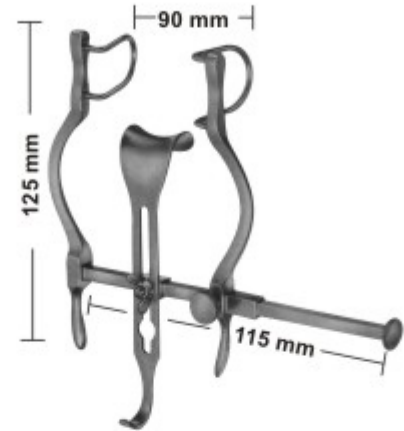

03-5435
BALFOUR-BABY
Lateral blades 27 mm deep
(03-5435) Center blade 21x24 mm

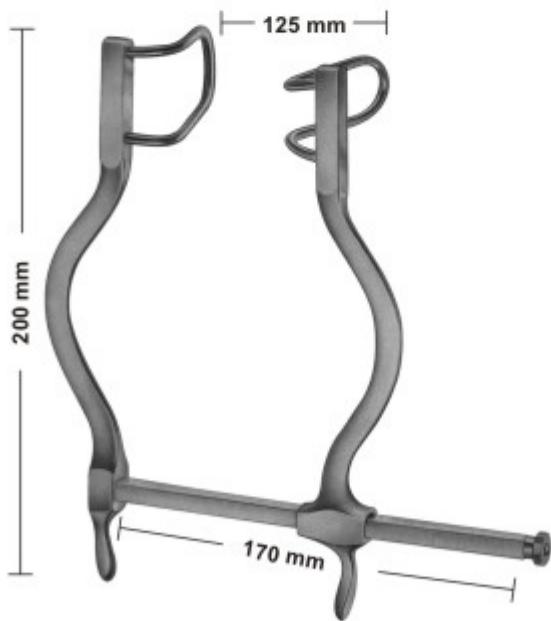

03-5436
GOSSET
Blades: 55 mm deep

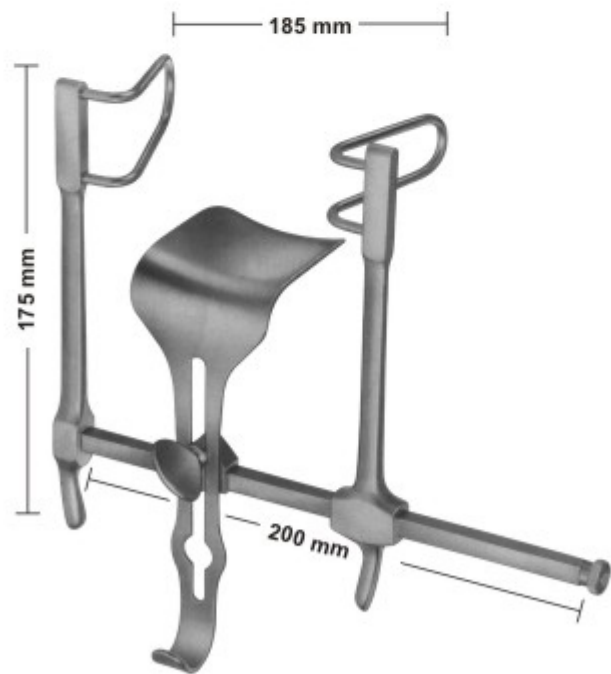

03-5437
GOSSET
Lateral blades 58 mm deep
Center blade
59 x 57 mm

Abdominal Retractors

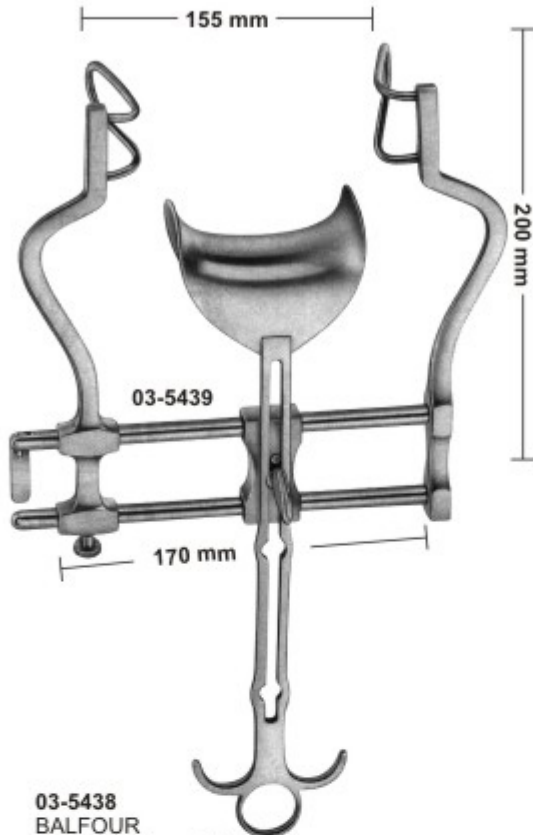

03-5438
BALFOUR
Lateral blades 60 mm deep
(03-5439) Center blade
47 x 80 mm

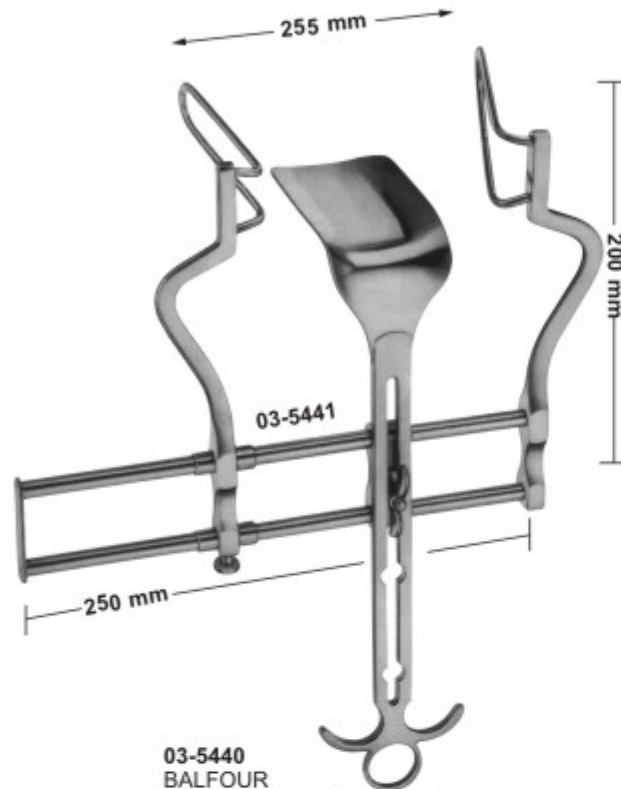

03-5440
BALFOUR
Lateral blades 105 mm deep
(03-5441) Center blade
107x 59 mm



03-5442
Center blade only
54x80 mm

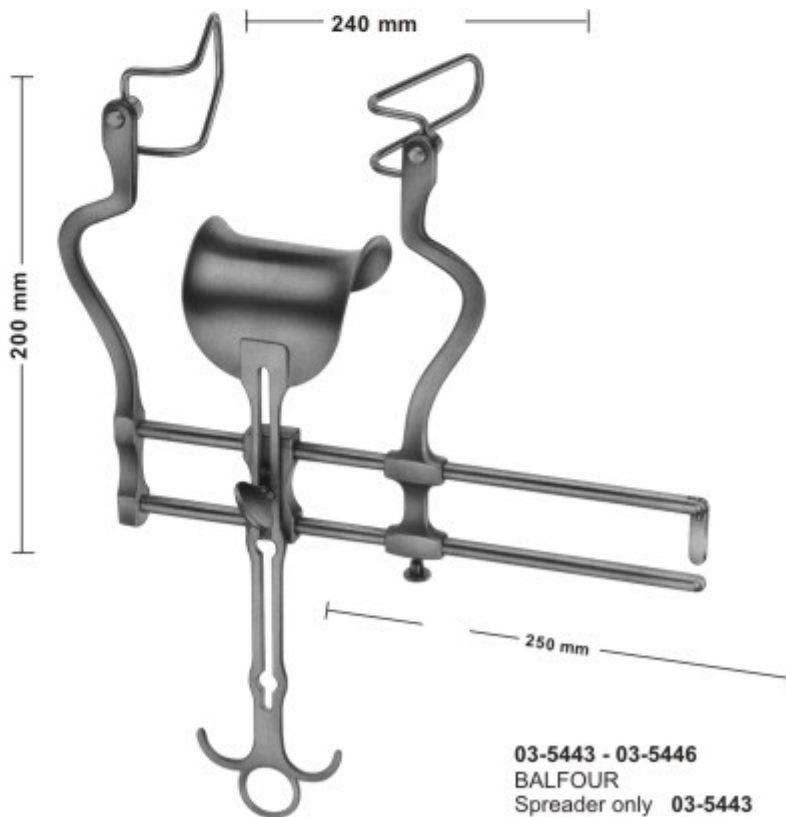

03-5443 - 03-5446

BALFOUR		03-5443	03-5444	03-5445	03-5446
Spreader only					
Lateral blades	50 mm	60 mm	75 mm	90 mm	
Center blade	47 x 80 mm	62x76 mm	80x80 mm	80x80 mm	



Sales Unit of blades:PR = pair

- Lateral blades
- 03-5447** 50 mm deep
- 03-5448** 60 mm deep
- 03-5449** 75 mm deep
- 03-5450** 90 mm deep

Abdominal Retractors

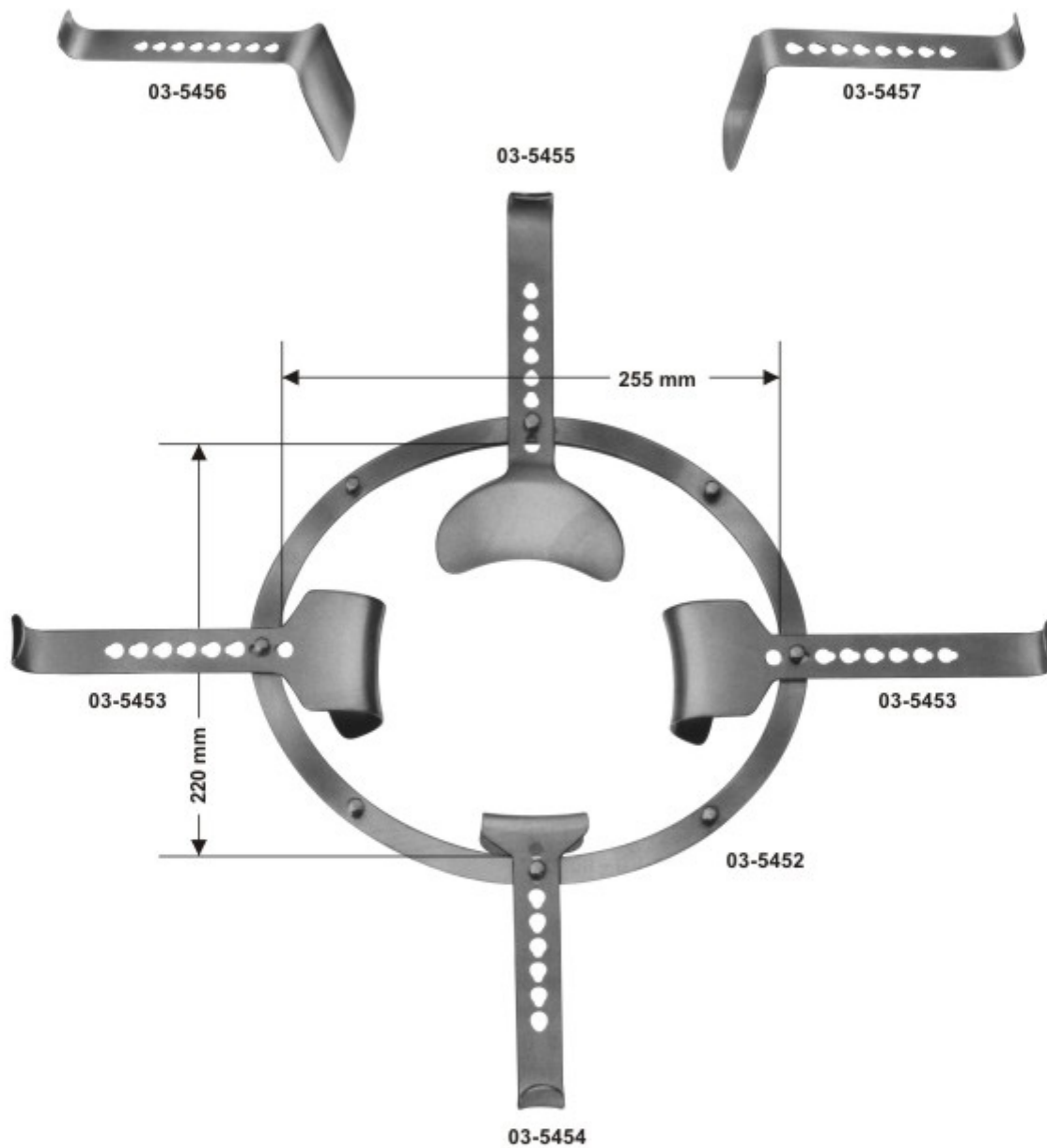

03-5451

SEMM

consisting of:

03-5452 1 frame 225 x 220 mm

03-5453 2 blades 46 x 64 mm

03-5454 1 blade 53 x 54 mm
(for bladder)

03-5455 1 blade 82 x 97 mm
(for intestine)

03-5456 1 blade 98 x 51 mm
(for intestine)

03-5457 1 blade, narrow
107 x 36 mm

Abdominal Retractors

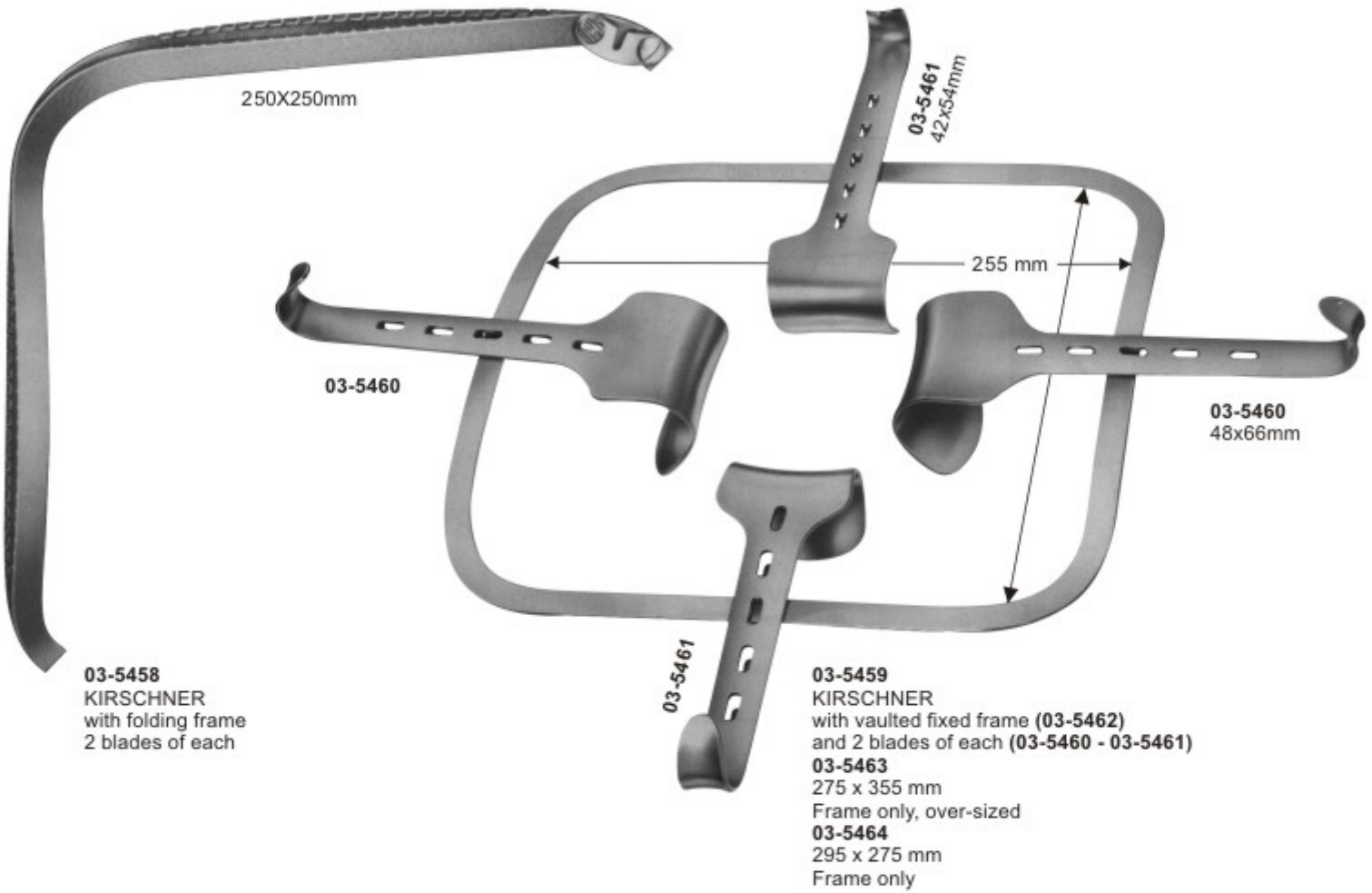

03-5465
KIRSCHNER
64 x 80 mm



03-5466
KIRSCHNER-BALFOUR
80x 82 mm



03-5467 - 03-5469
KIRSCHNER
03-5467 90x 69mm
03-5468 92x 95mm
03-5469 78x 58mm



03-5470 - 03-5472
KIRSCHNER
03-5470 108x42mm
03-5471 91x 55mm
03-5472 121x 55mm

Addition valves for corpulent persons.

Intestinal and Tissue Grasping Forceps

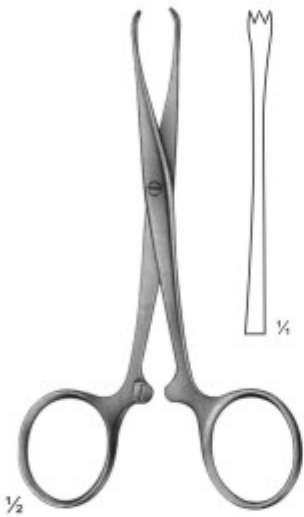

03-5473
CHAPUT
 2 X 3 teeth, sharp
 125 mm,

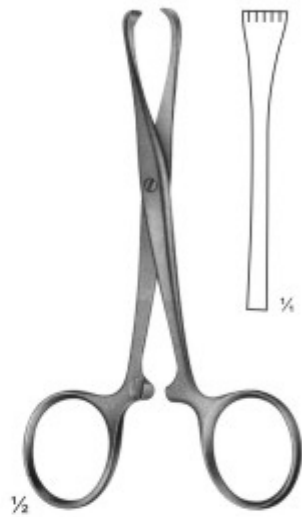

03-5474
TUFFIER
 5 X 6 teeth, sharp
 125 mm,



03-5475
BOYS-ALLIS
 5 X 6 teeth, sharp
 155 mm,



03-5476
BABY-ALLIS
 4 X 5 teeth
 130mm

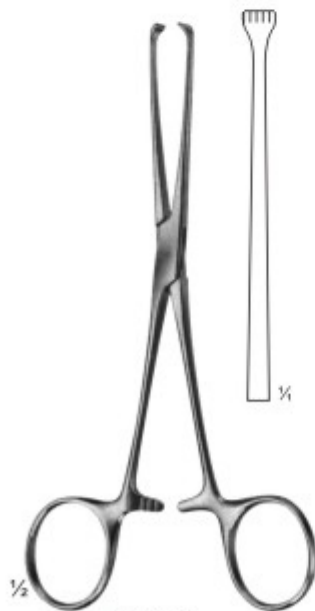

03-5477
ALLIS
 4 X 5 teeth
 155 mm,

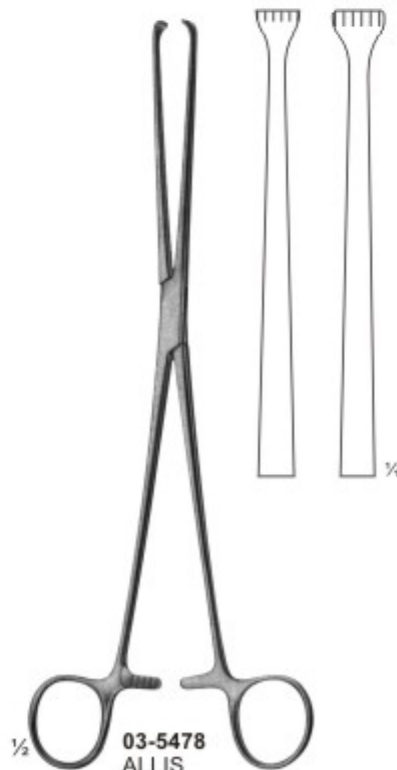

03-5478
ALLIS
 190 mm,
03-5479
JUDD-ALLIS
 255 mm,
 5 X 6 teeth
 Slender pattern

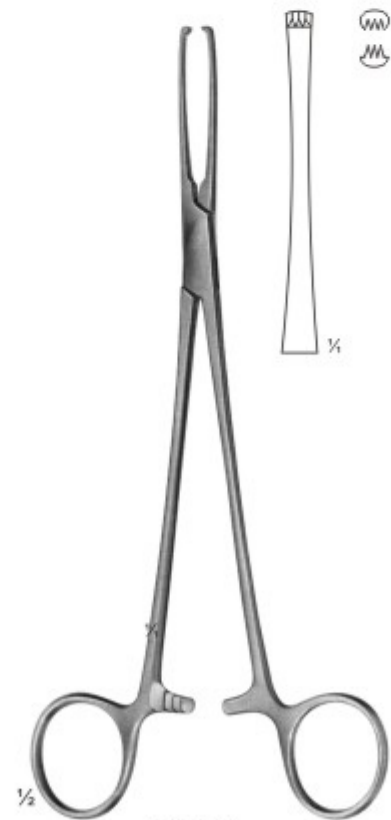

03-5480
JUDD-ALLIS
 3 X 4 teeth
 195 mm,

Intestinal Grasping Forceps



03-5481
BABCOCK
155 mm

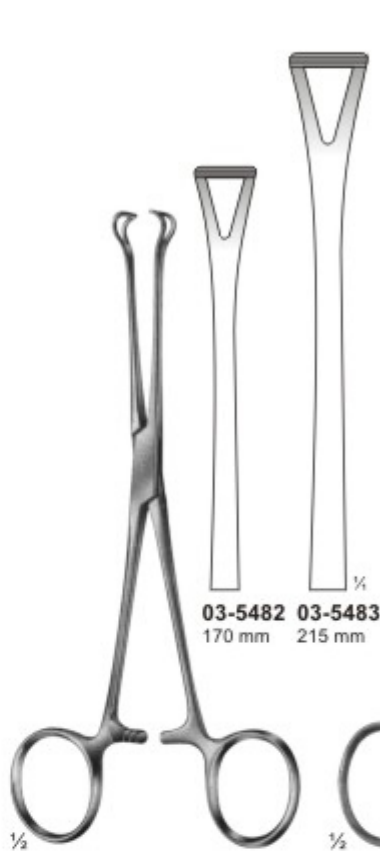

03-5482 03-5483
170 mm 215 mm

03-5482 - 03-5483
BABCOCK

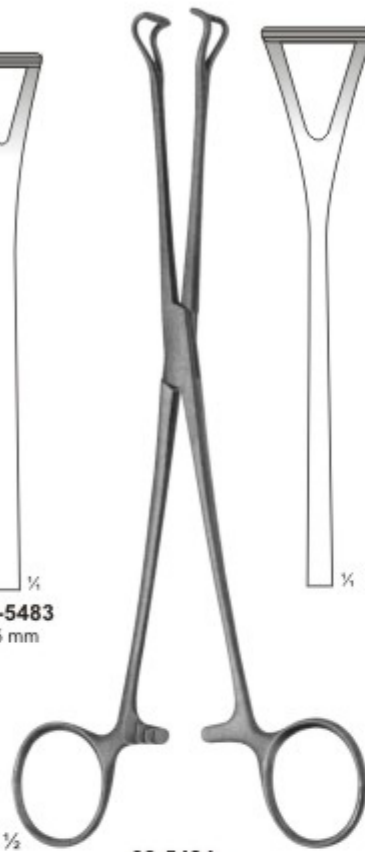

03-5484
BABCOCK
220 mm



03-5485
COLLIN
140 mm,

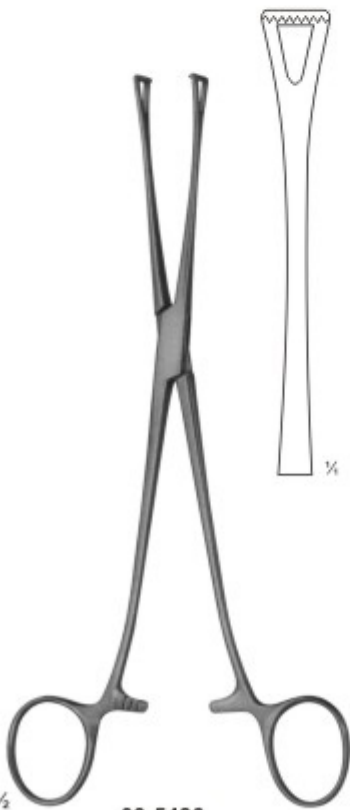

03-5486
LOCKWOOD
200 mm,

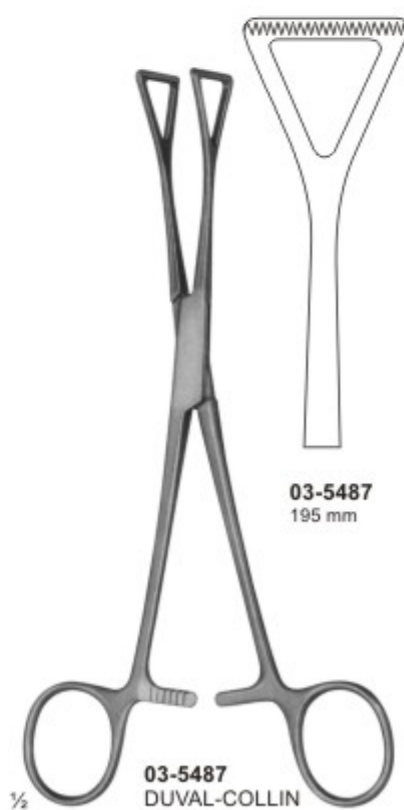

03-5487
DUVAL-COLLIN
195 mm
03-5488
200 mm

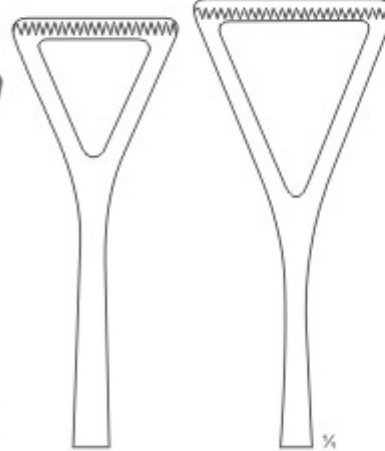

03-5487
195 mm

03-5488
200 mm

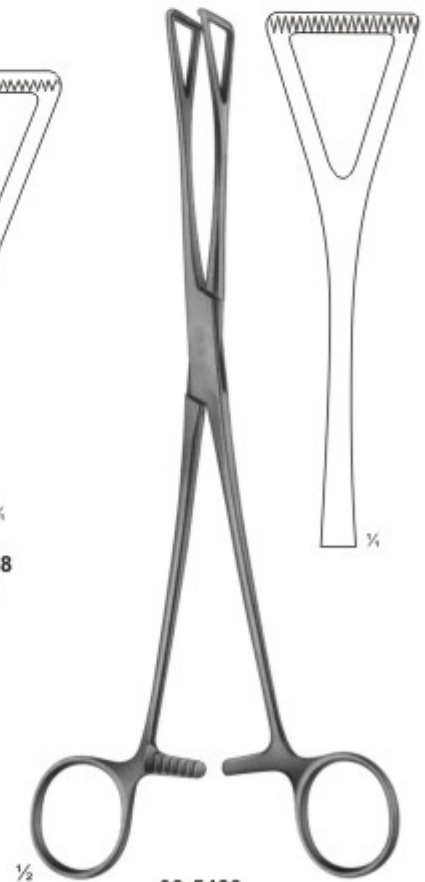

03-5489
DUVAL
230 mm,

Organ - Tissue Grasping, Intestinal and Dissecting Forceps



03-5490 - 03-5492
LANE

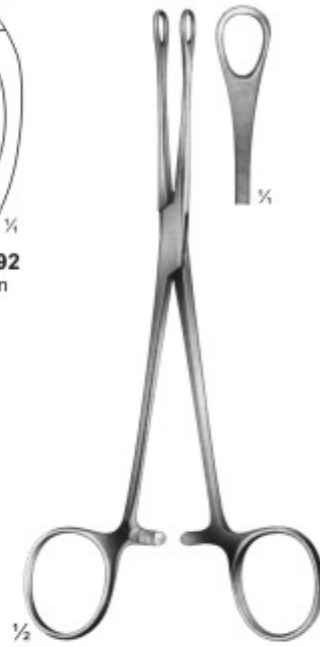

03-5493
WILLIAMS
160 mm



03-5494
DENIS
BROWNE
190 mm



03-5495
DUVAL
140 mm



03-5496 - 03-5497
WANGENSTEEN
03-5496 150 mm
03-5497 230 mm

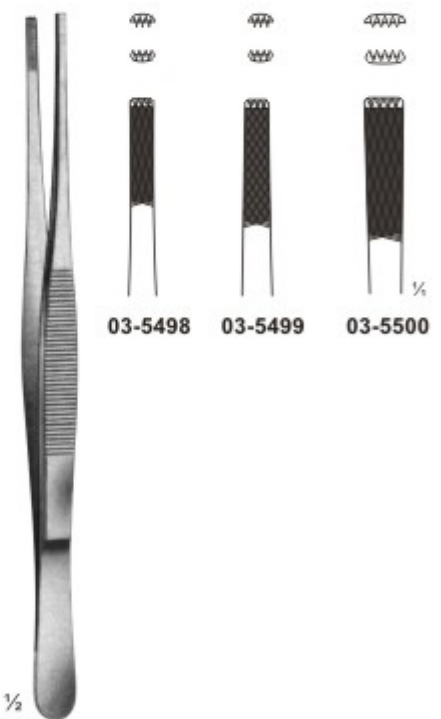

03-5498 - 03-5500
STILLÉ-BARRAYA
03-5498 180mm
03-5499 200mm
03-5500 250mm

Organ - Tissue Grasping & Intestinal Forceps ATRAUMATA

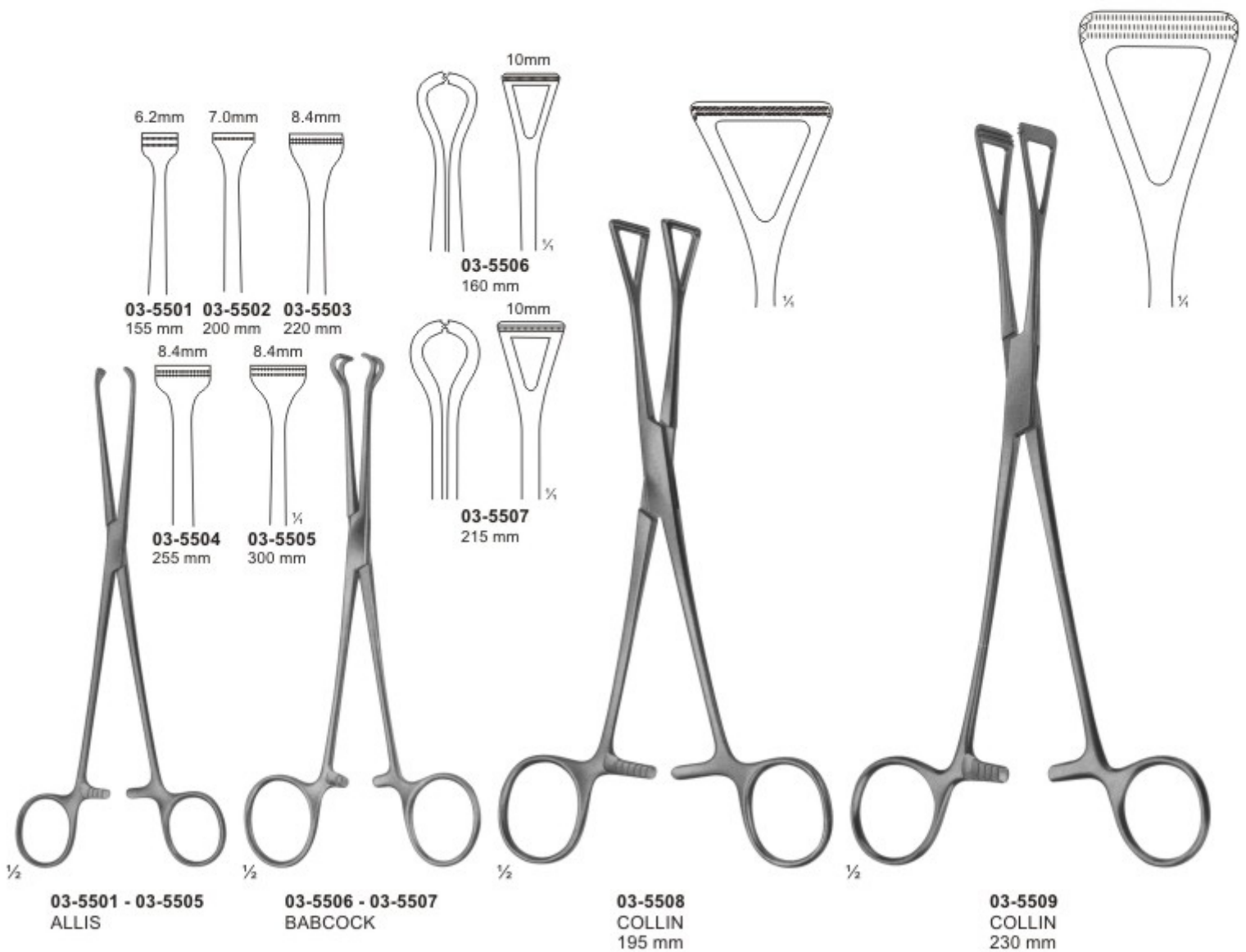

Ultra - Light - Forceps, Dissecting Forceps ATRAUMATA

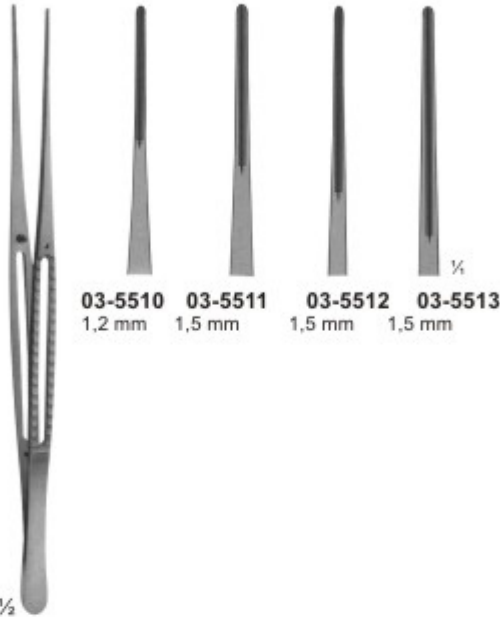

03-5510 - 03-5513
03-5510 150 mm
03-5511 200 mm
03-5512 240 mm
03-5513 300 mm



03-5514 - 03-5517
DE BAKEY
03-5514 150 mm
03-5515 200 mm
03-5516 240 mm
03-5517 300 mm

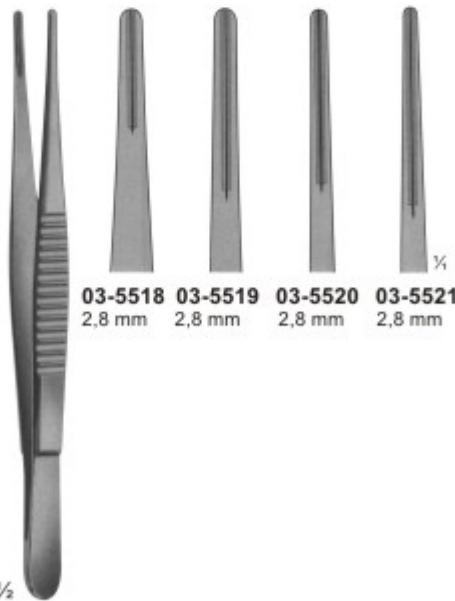

03-5518 - 03-5521
DE BAKEY
03-5518 150 mm
03-5519 200 mm
03-5520 240 mm
03-5521 300 mm



03-5522 - 03-5524
DE BAKEY
03-5522 200 mm
03-5523 240 mm
03-5524 300 mm

Intestinal Clamps for Children

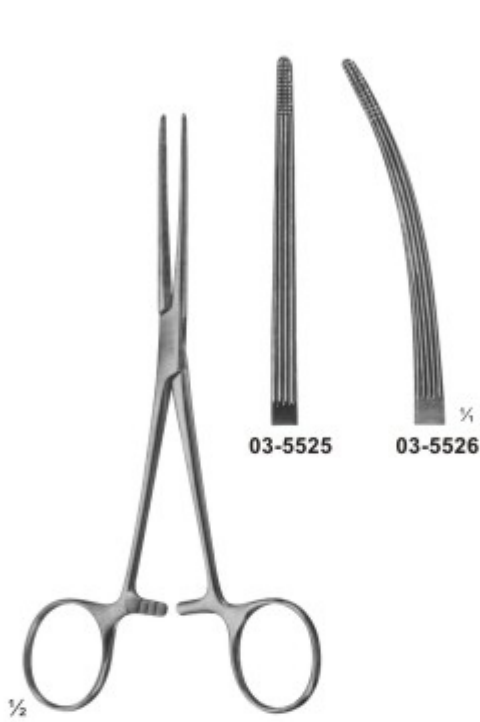

03-5525 - 03-5526
BAINBRIDGE
155 mm



03-5527
ALLEN
155 mm

Atraumata



03-5528 - 03-5529
BABY-KOCHER
very elastic blades
130 mm

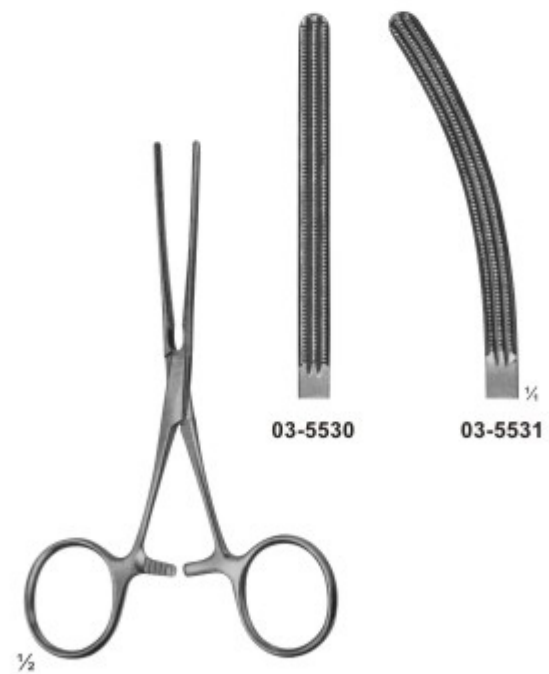

03-5530 - 03-5531
BABY-KOCHER
with elastic blades
130 mm

Intestinal Clamps, Soft Elastic

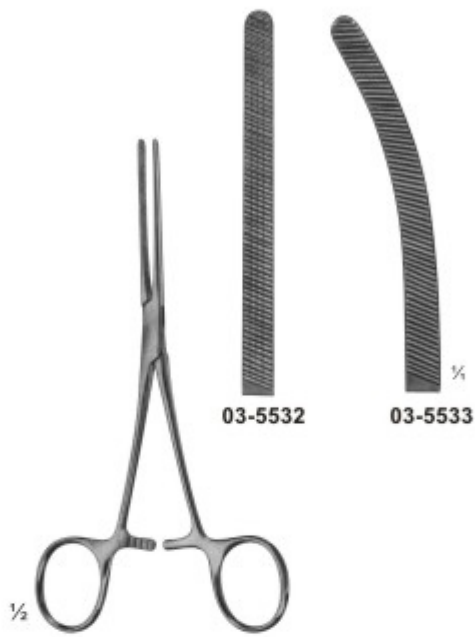

03-5532 - 03-5533
DOYEN
elastic
165 mm

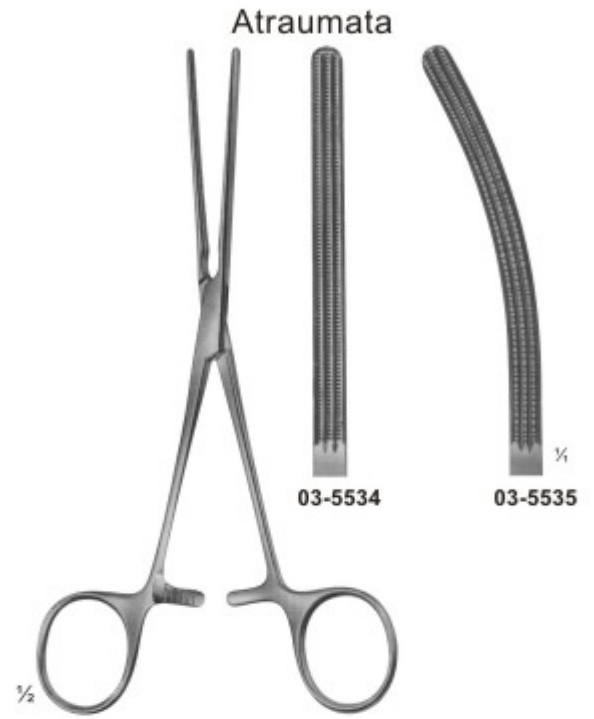

03-5534 - 03-5535
DOYEN
with elastic blades
170 mm

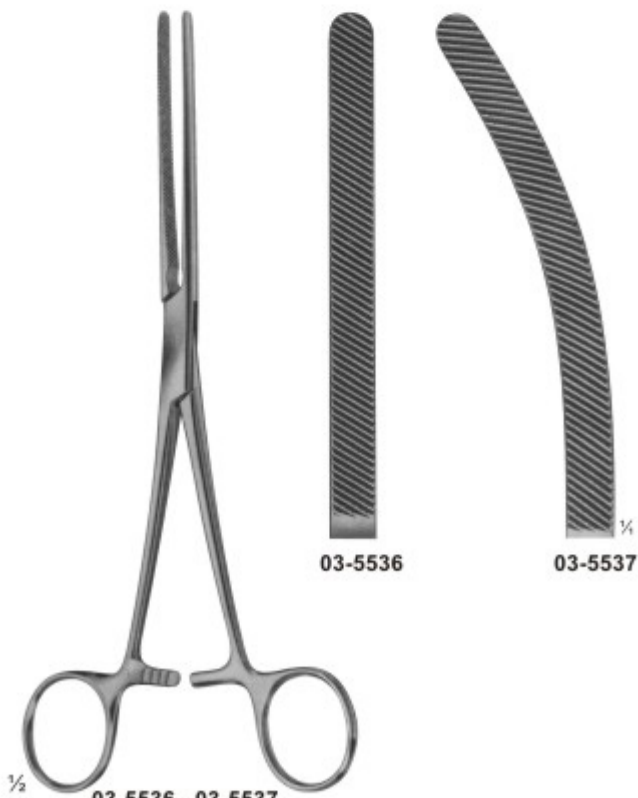

03-5536 - 03-5537
HARTMANN
with elastic blades
200 mm



03-5538 - 03-5539
HARTMANN
with elastic blades
200 mm

Intestinal Clamps, Soft elastic

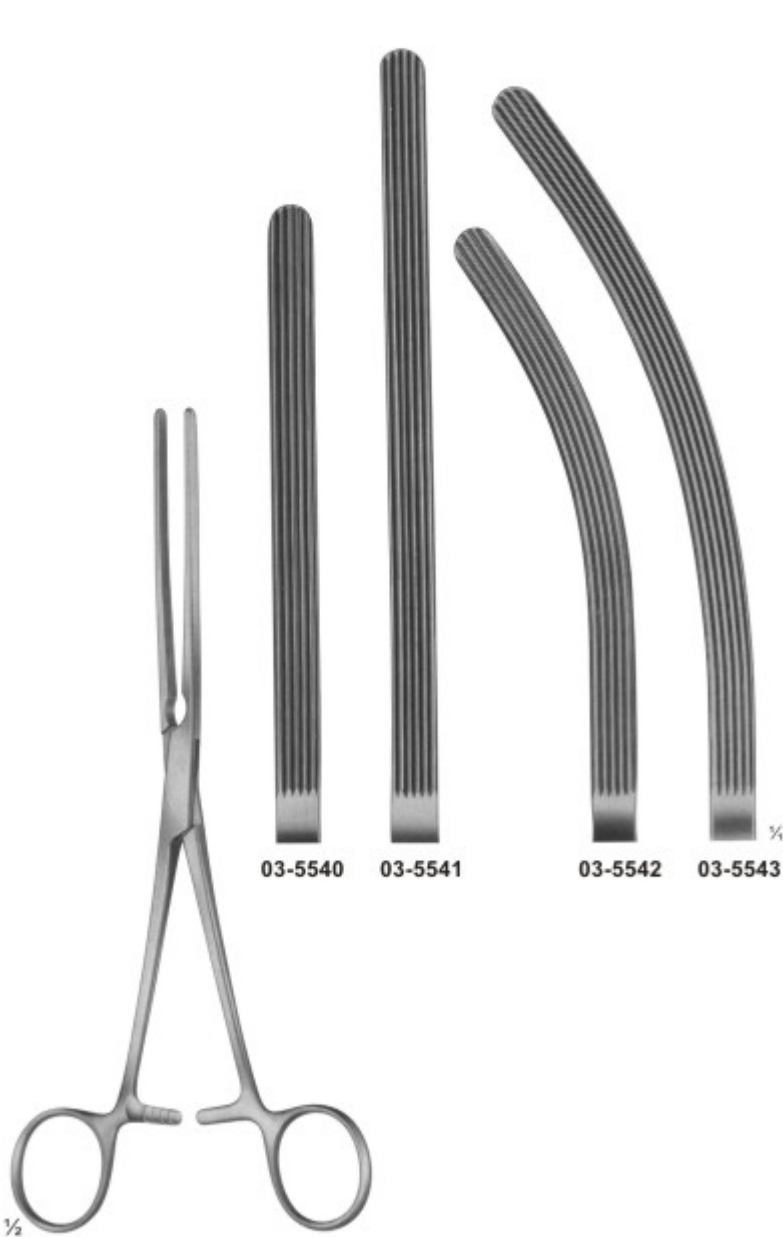

03-5540 - 03-5543
KOCHER
 with elastic blades
03-5540-03-5542 210 mm
03-5541-03-5543 230 mm

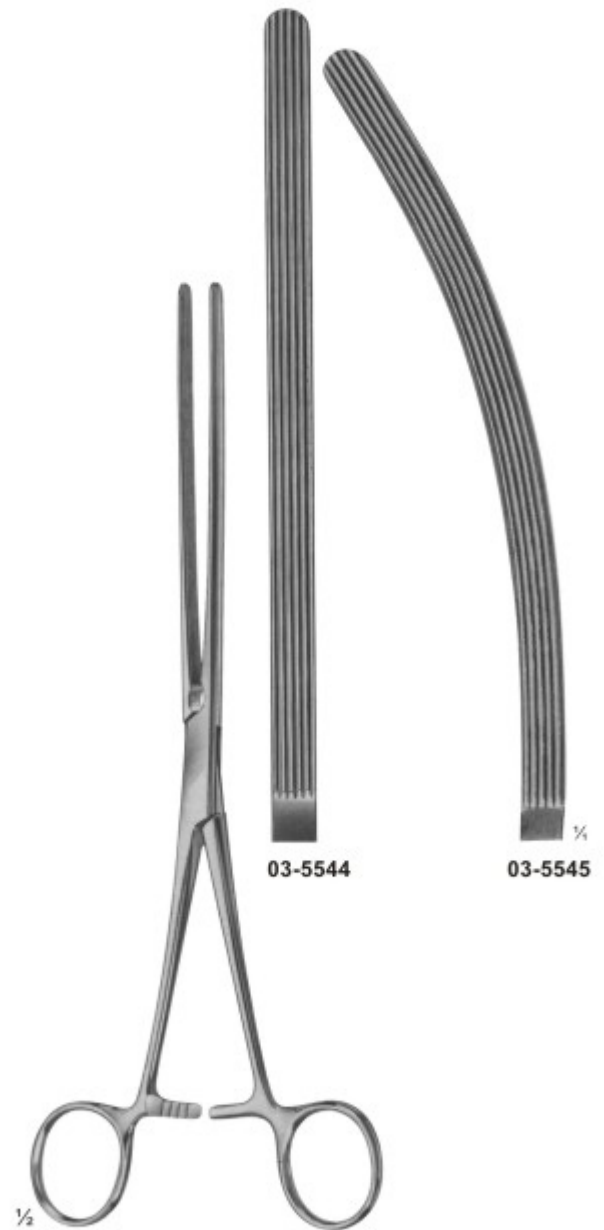

03-5544 - 03-5545
DOYEN
 with elastic blades
 240 mm

Intestinal Clamps, Soft elastic

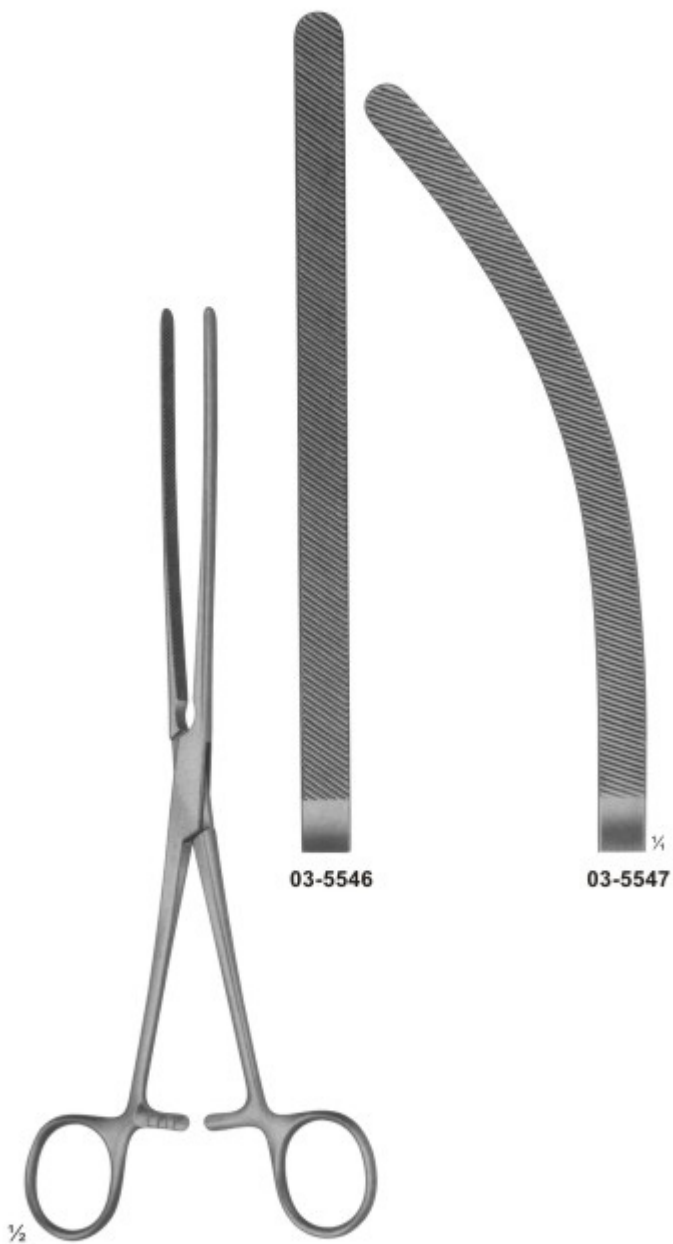

03-5546 - 03-5547
DOYEN
with elastic blades
235 mm

Atraumata

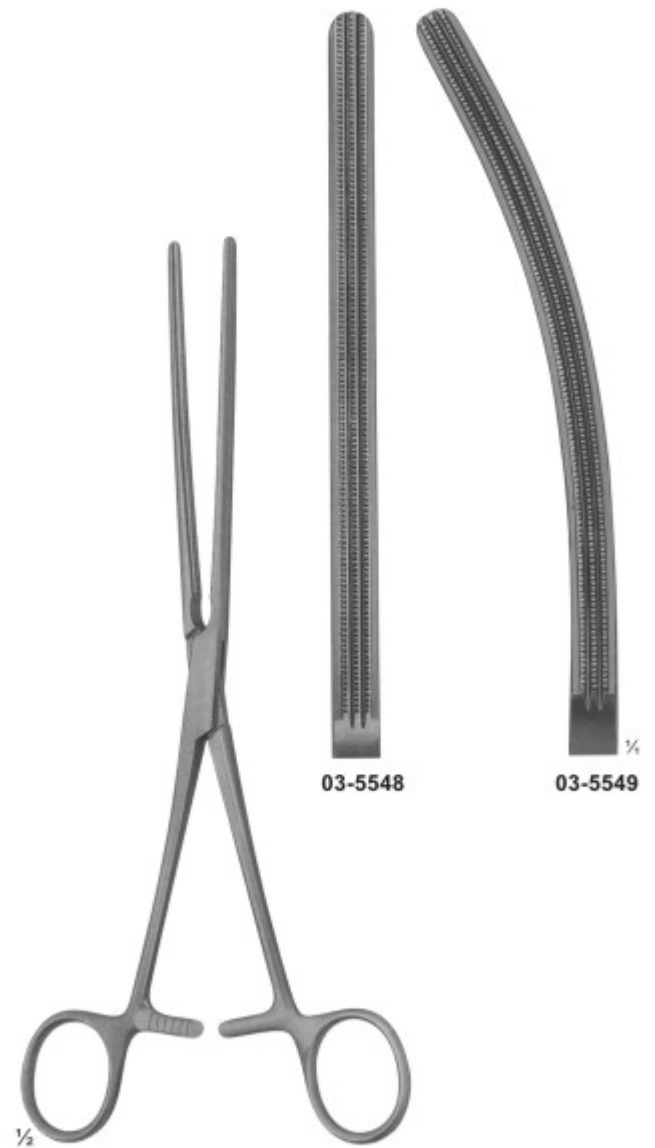

03-5548 - 03-5549
DOYEN
with elastic blades
230 mm

Intestinal Clamps, Soft elastic

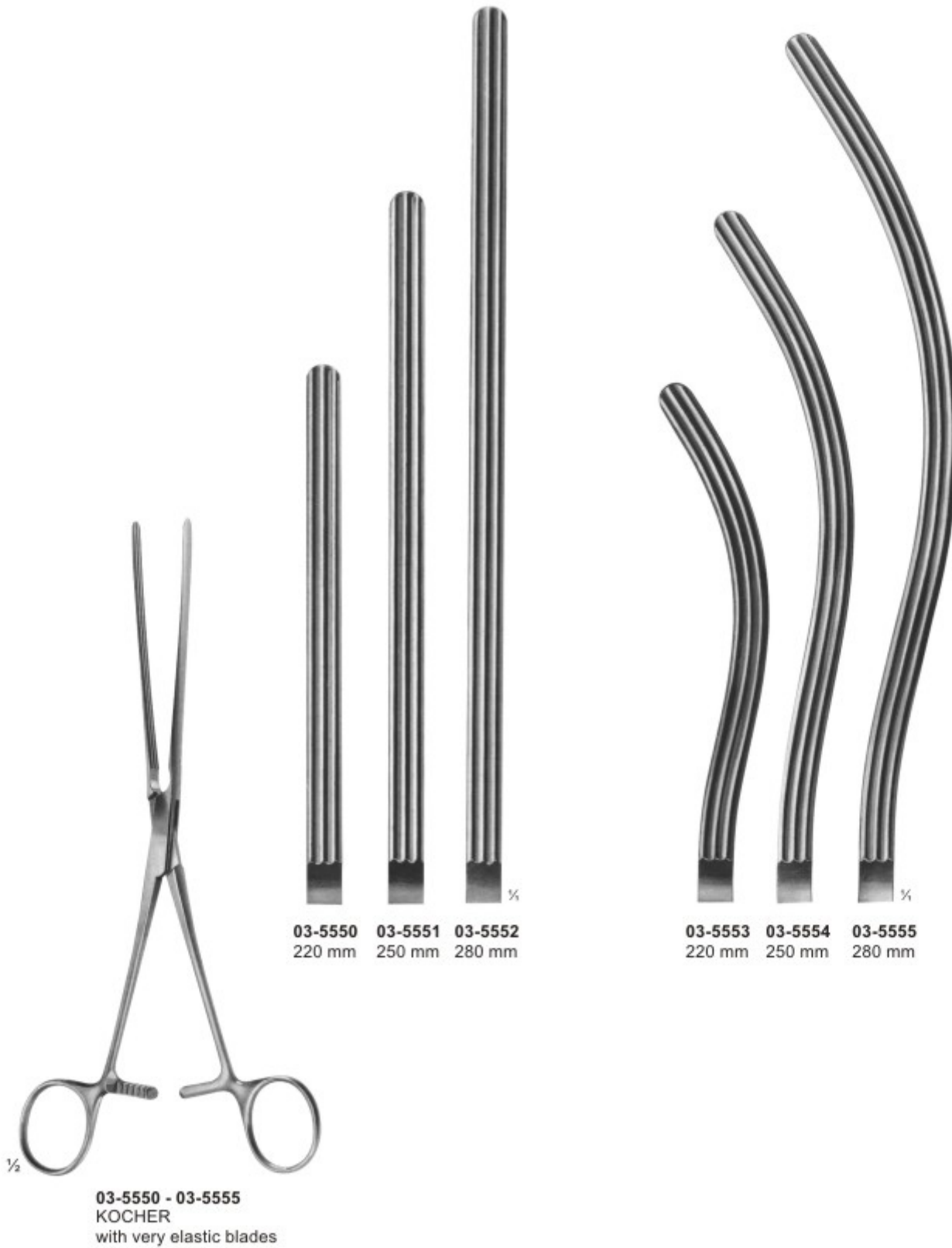

1/2

03-5550 - 03-5555
KOCHER
with very elastic blades

03-5550 220 mm
03-5551 250 mm
03-5552 280 mm

03-5553 220 mm
03-5554 250 mm
03-5555 280 mm

Intestinal Clamps, Soft elastic

Atraumata

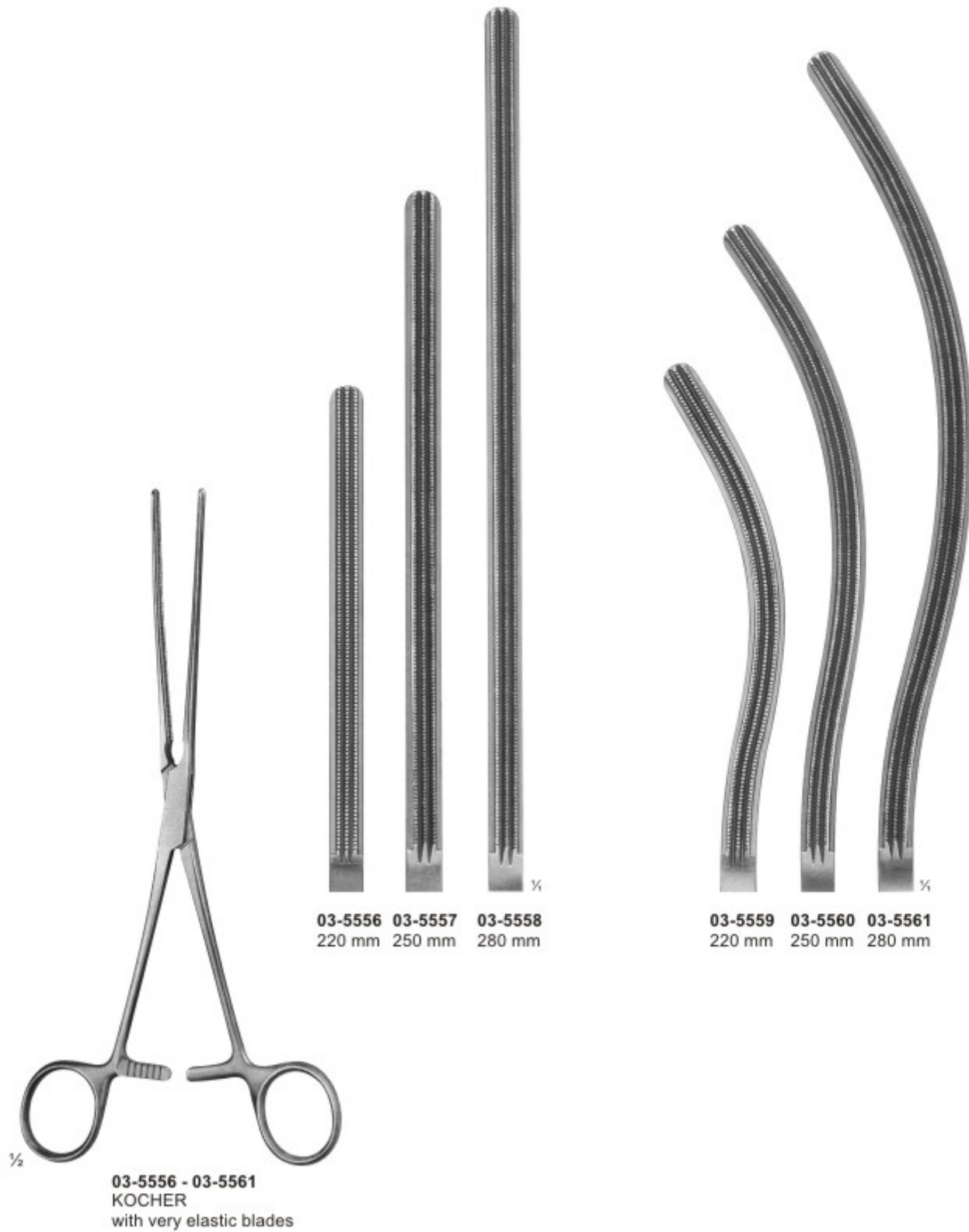

Intestinal Clamps

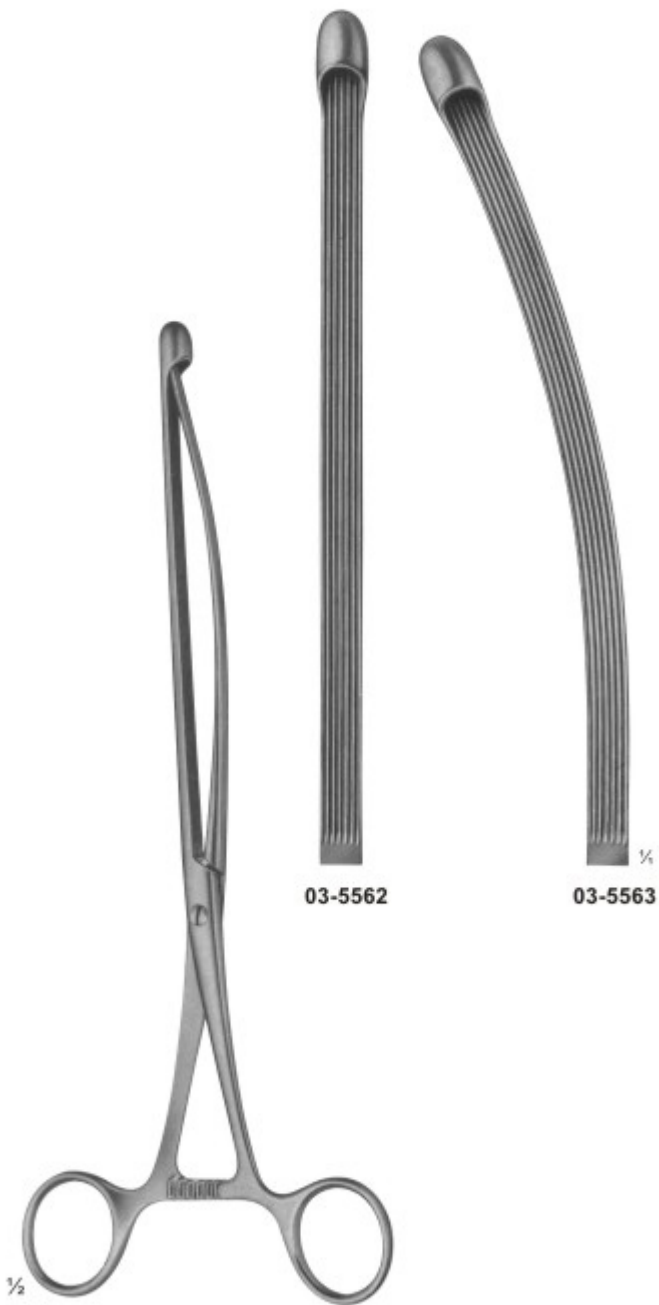

03-5562 - 03-5563
NUSSBAUM
with elastic blades
250 mm

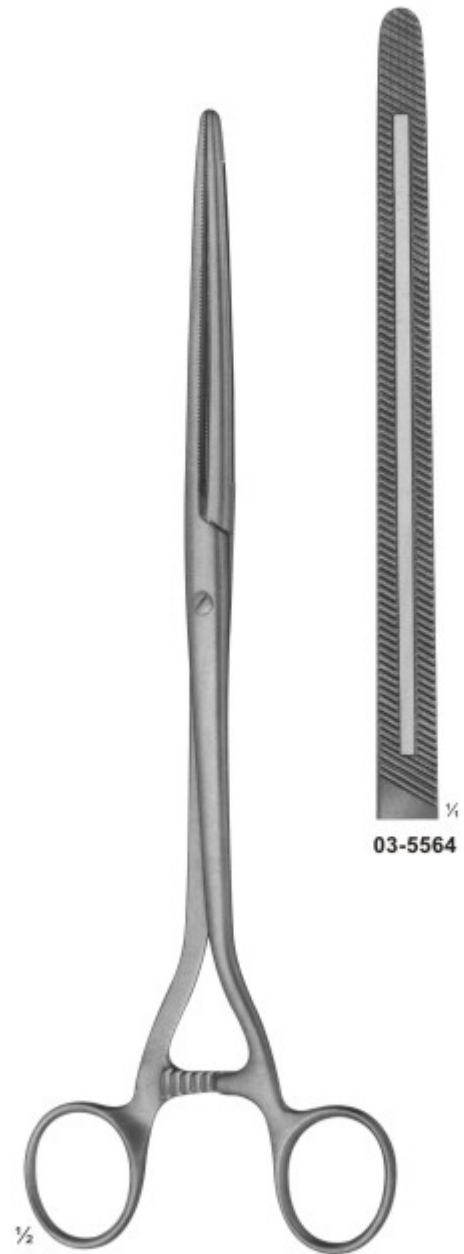

03-5564
MOYNIHAN
280 mm

Intestinal Clamps

Atraumata

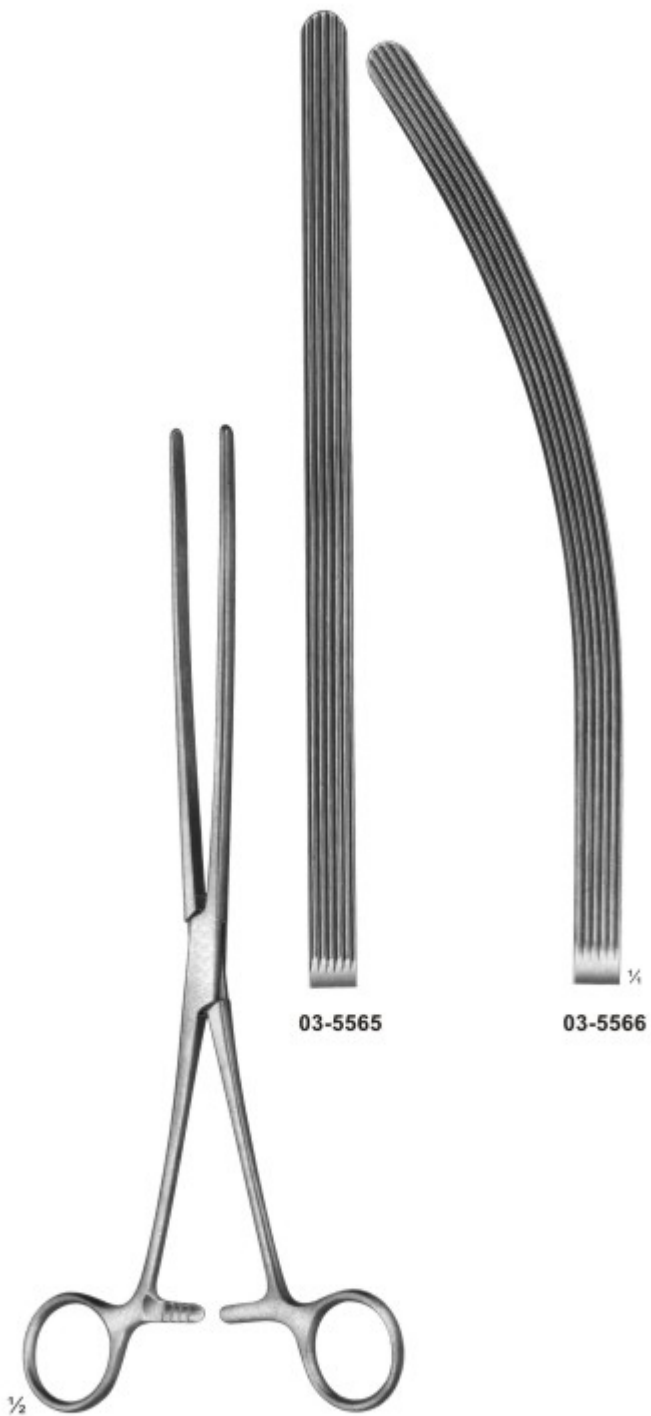

03-5565 - 03-5566
MAYO-ROBSON
hard elastic
250 mm

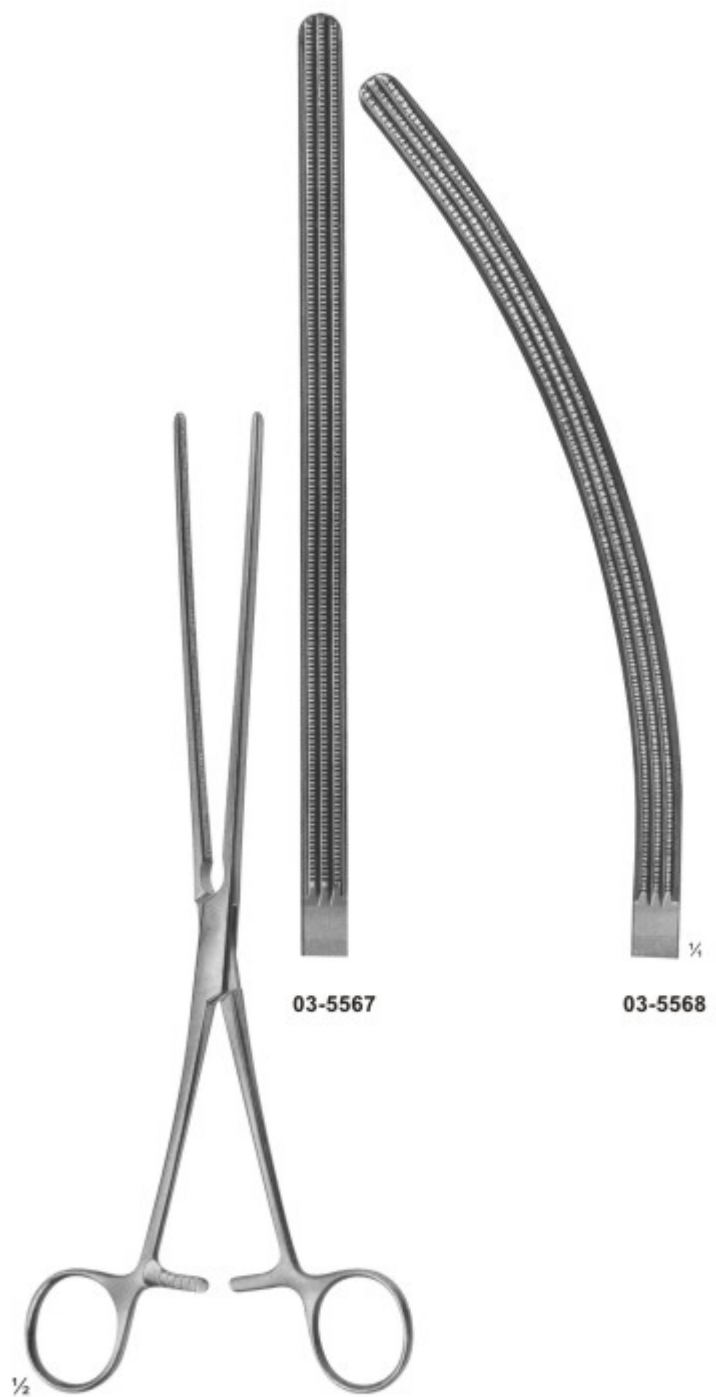

03-5567 - 03-5568
MAYO-ROBSON
250 mm

Gastro-Intestinal Forceps, twin



03-5569
LANE
300 mm

03-5570
LANE
300 mm

Stomach Clamps

Atraumata



Intestinal and Pylorus Clamps



1/2
03-5574
PAYR
Intestinal clamp
light pattern,
for children
180 mm

1/2
03-5575
PAYR
200 mm

1/2
03-5576
PAYR
275 mm

1/2
03-5577
PAYR
Pylorus clamp
315 mm

Anastomosis Forceps

Atraumata



03-5578
PARKER-KERR
anastomosis forceps
for colon resection
250 mm

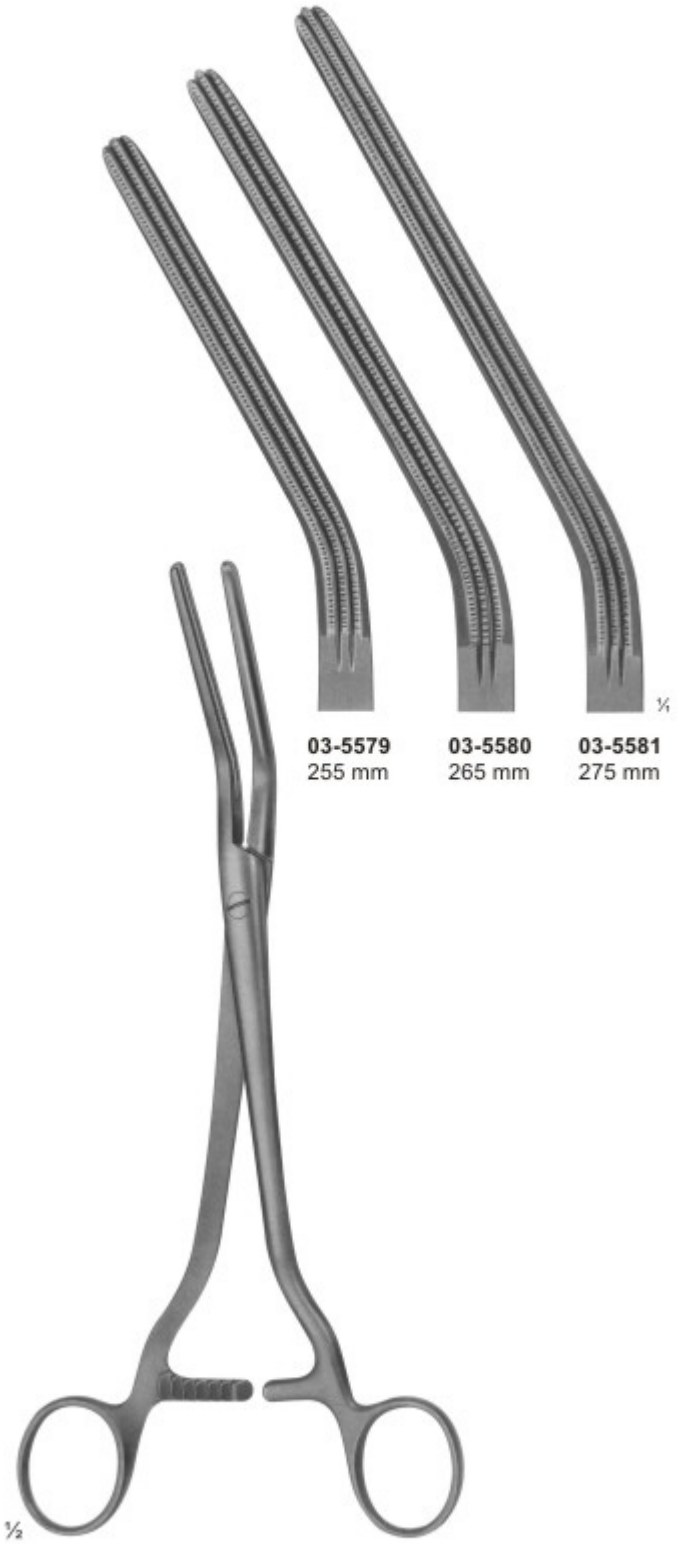

03-5579
255 mm

03-5580
265 mm

03-5581
275 mm

03-5579 - 03-5581
DICK
pressure clamps

Sigmoid Anastomosis Forceps



Atraumata Sigmoid Anastomosis Forceps

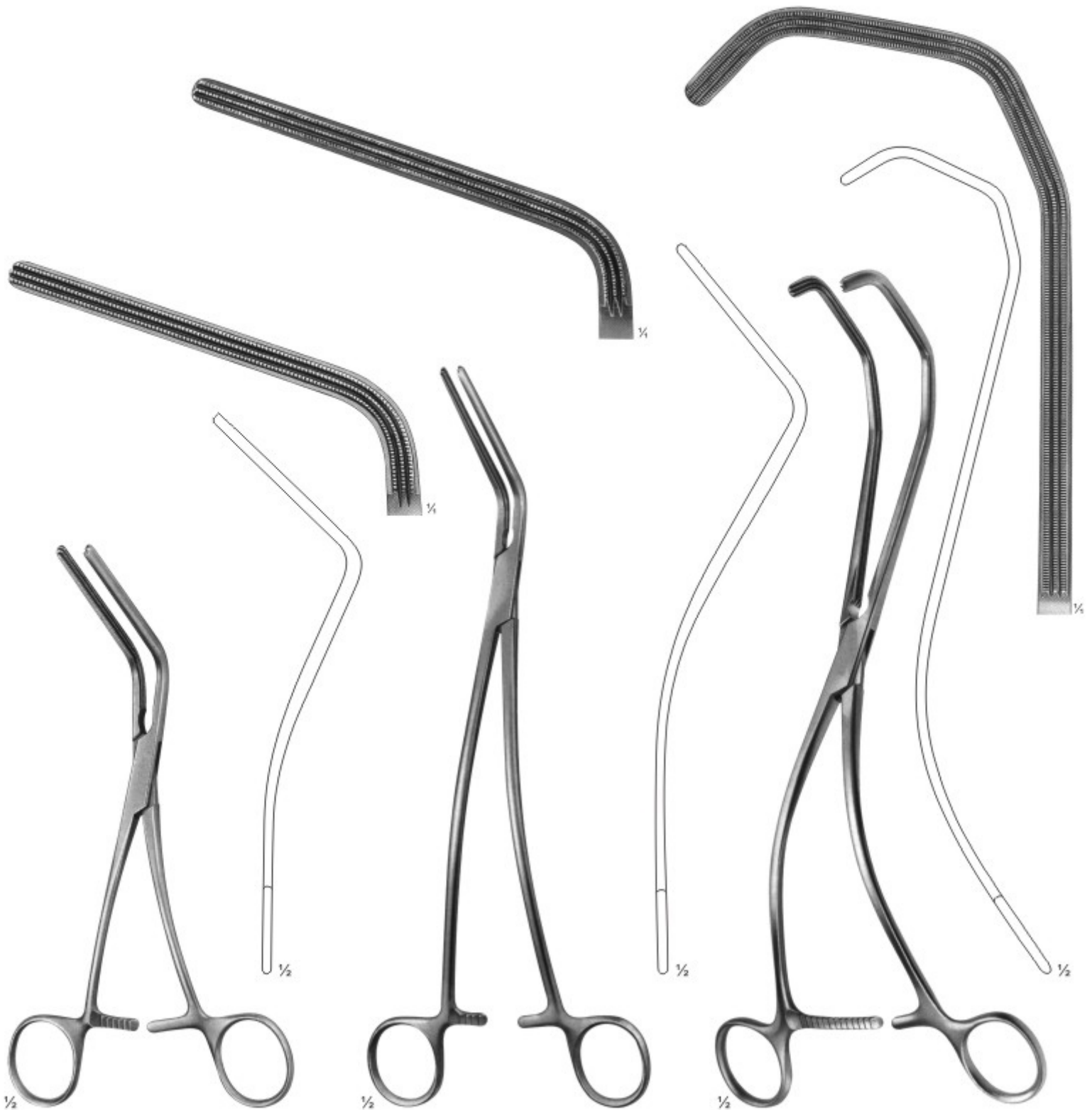

03-5585
MORRIS
175 mm

03-5586
DE BAKEY
(MORRIS modif.)
240 mm

03-5587
KERSTING
270 mm

Rectal Specula

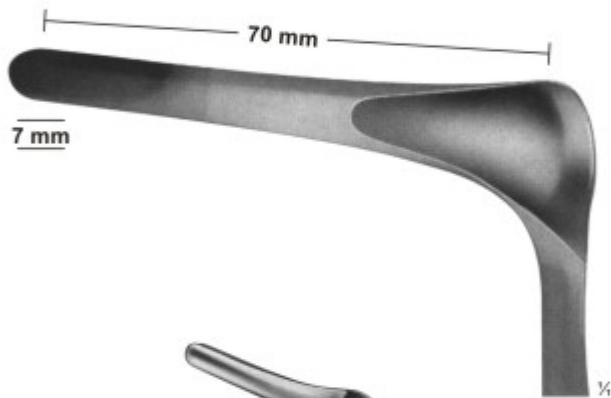

½
03-5588
KILLIAN
for children
145 mm



½
03-5589
SIMS
160 mm



½
03-5590
SIMS
160 mm

Rectal Specula

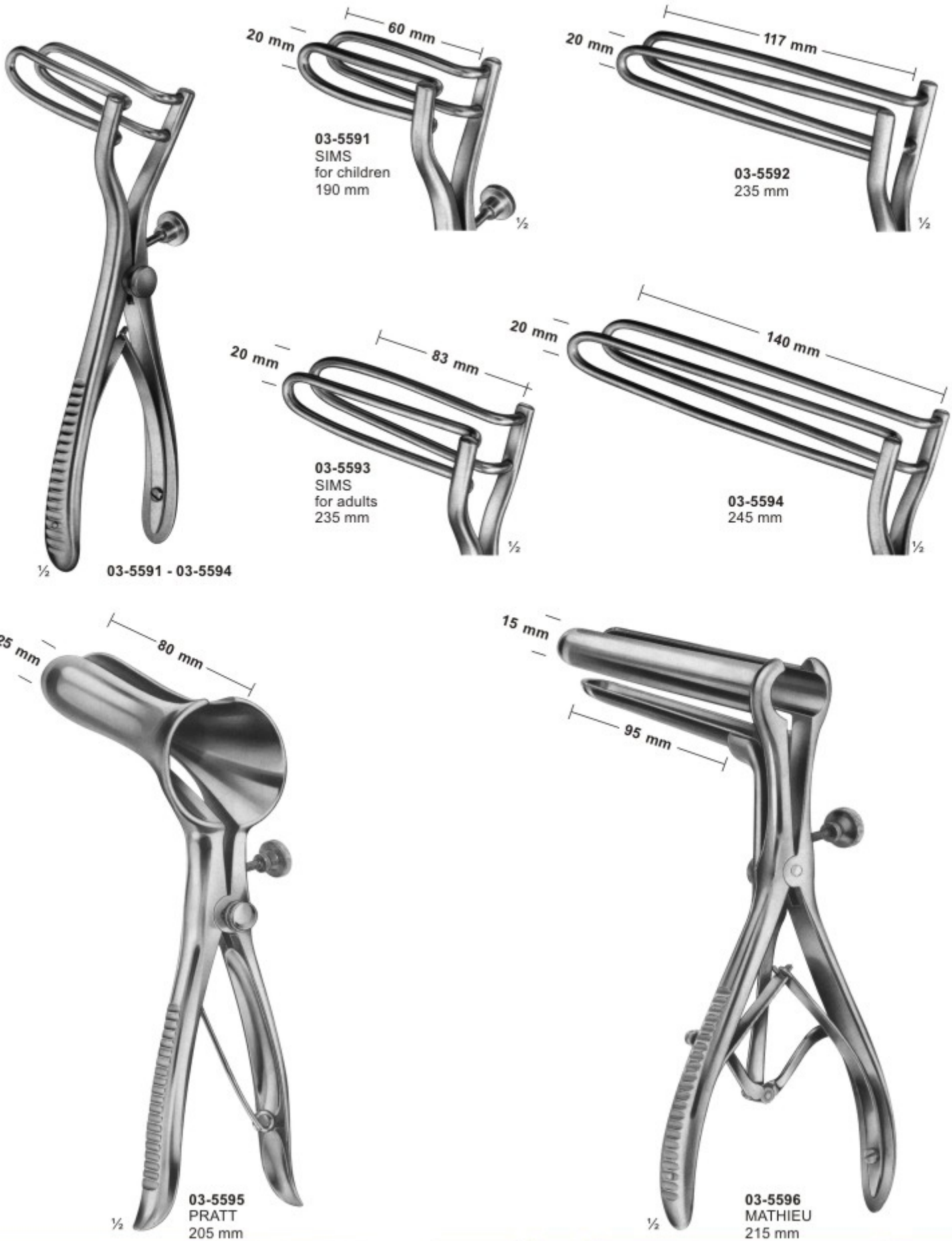

Anuscopy-Sphincteroscopes, Proctoscopes



03-5597
IVES-FANSLER
Anuscope
145 mm
Ø 24mm



03-5598
KELLY
Sphincteroscope
160 mm
Ø 21mm



03-5599
KELLY
Sphincteroscope
160 mm
Ø 27mm

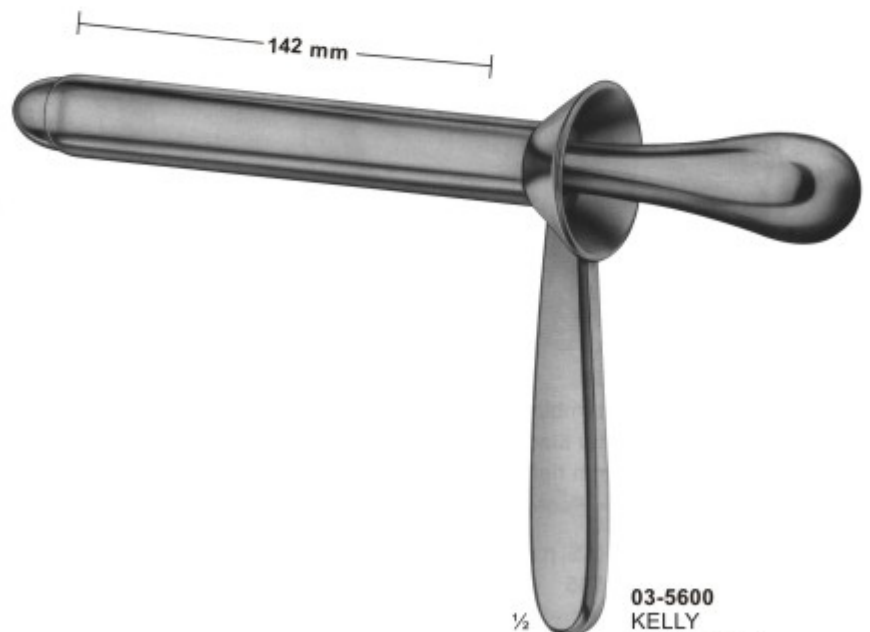

03-5600
KELLY
Proctoscope
140 mm
Ø 22mm

Biopsy forceps for rectum

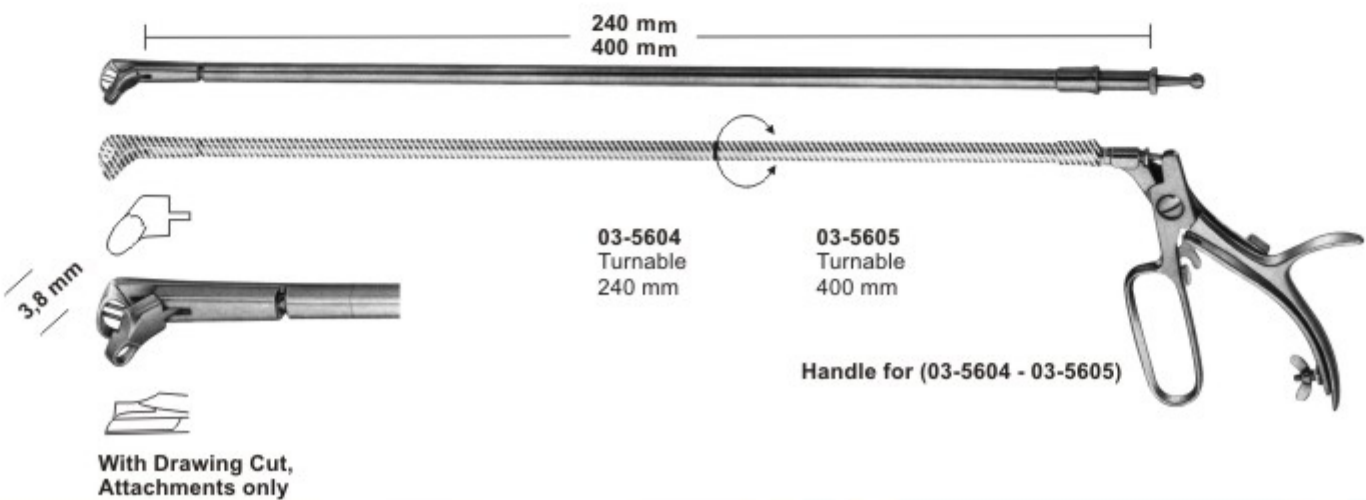
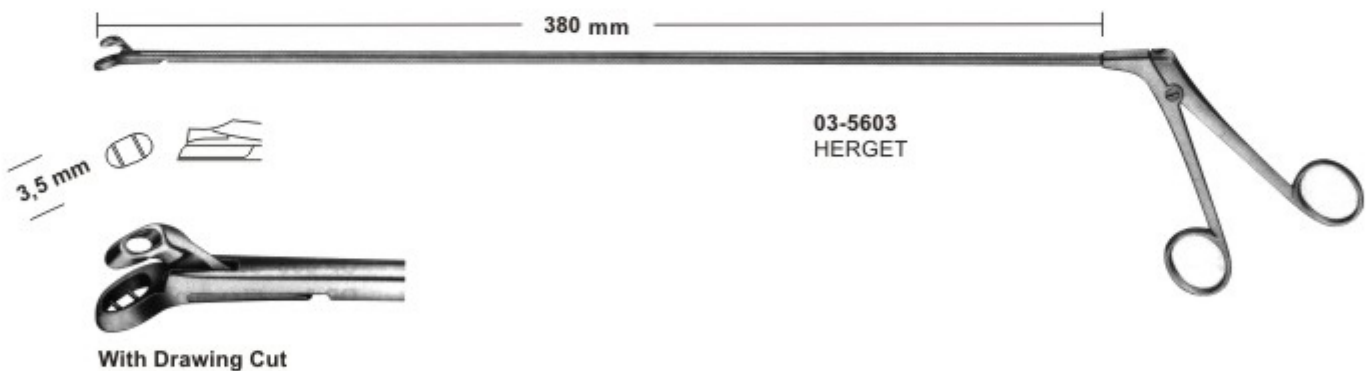
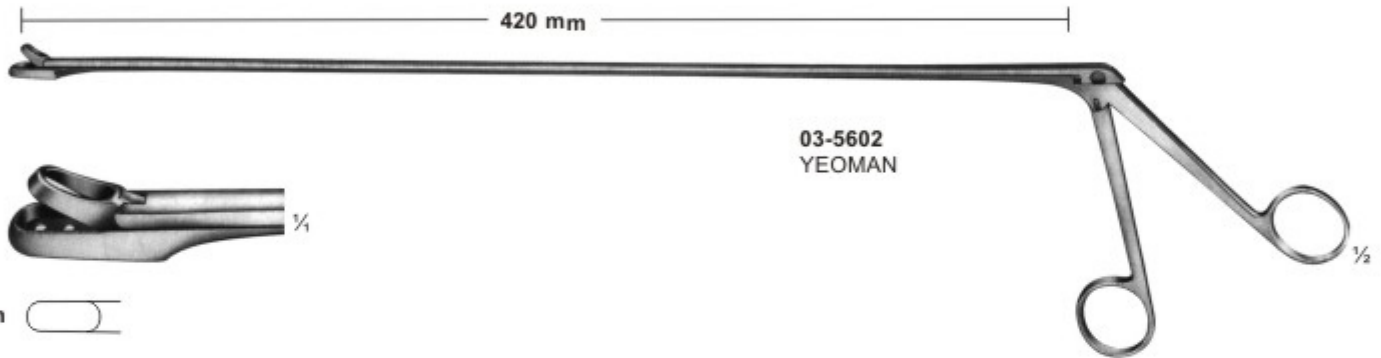
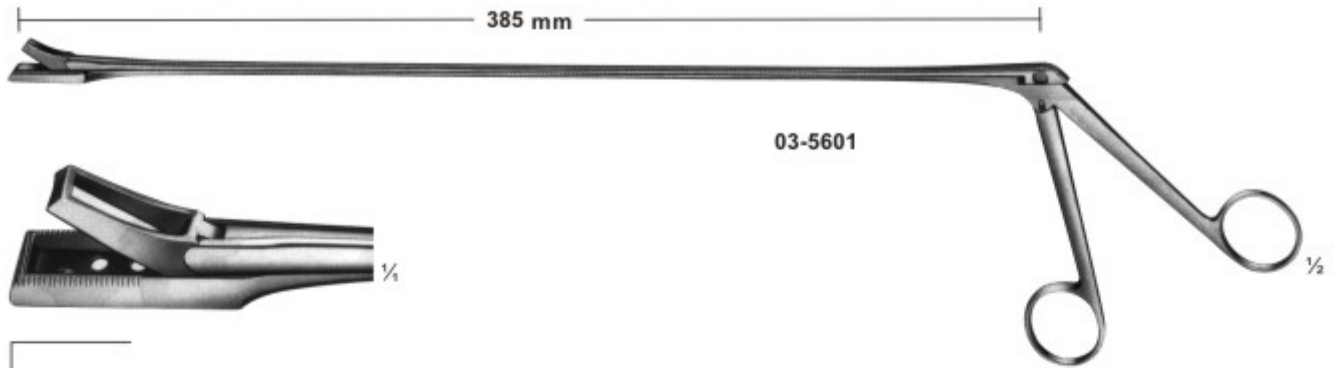

Biopsy Forceps & Swab Holders

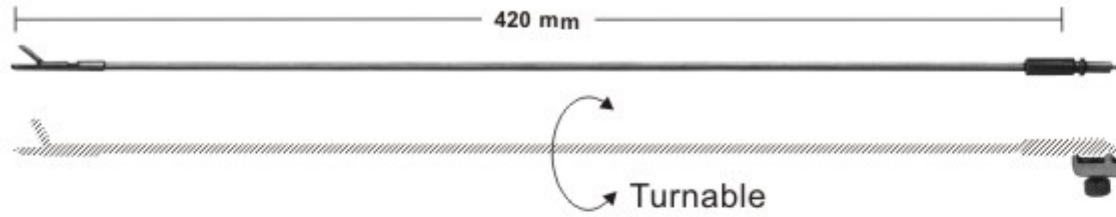

3,5 mm   ¼ 03-5606

3,5 mm   ¼ 03-5607

4,0 mm   ¼ 03-5608

4,0 mm   ¼ 03-5609

Biopsy Forceps

03-5606 - 03-5609
Handle for

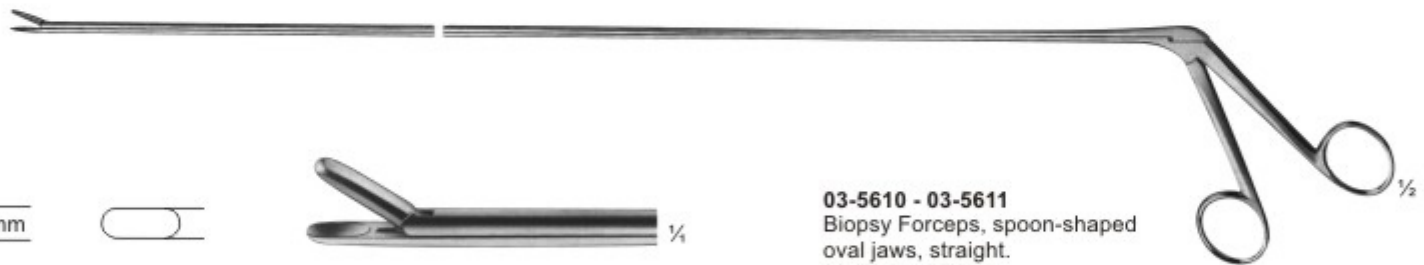

03-5610 - 03-5611
Biopsy Forceps, spoon-shaped
oval jaws, straight.
03-5610 350mm
03-5611 500mm

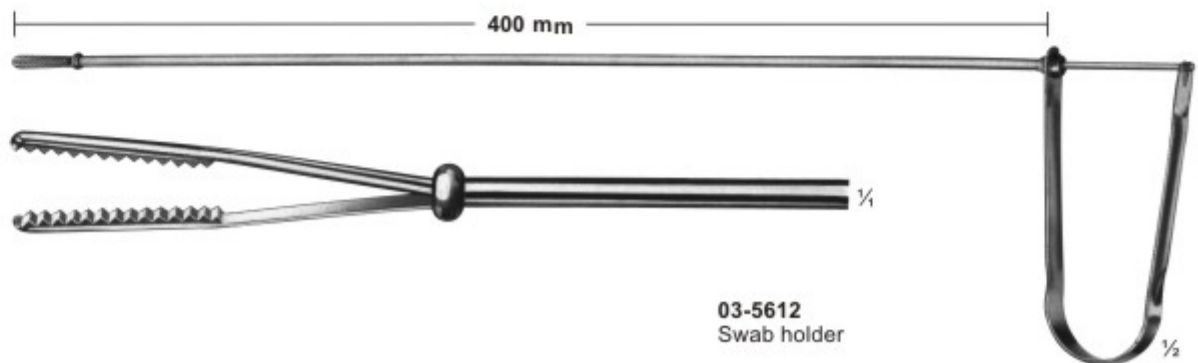

Haemorrhoidal Forceps



03-5613 - 03-5614
LUER

03-5613
220 mm

03-5614
245 mm

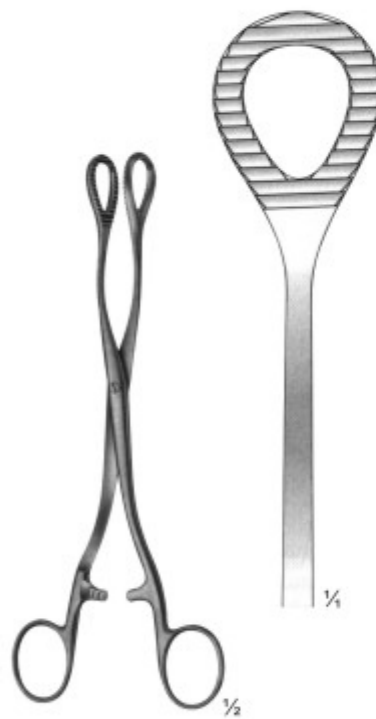

03-5615
HEYWOOD-SMITH
200 mm



03-5616
HEYWOOD-SMITH
modif
215 mm

Haemorrhoidal Forceps

Atraumata

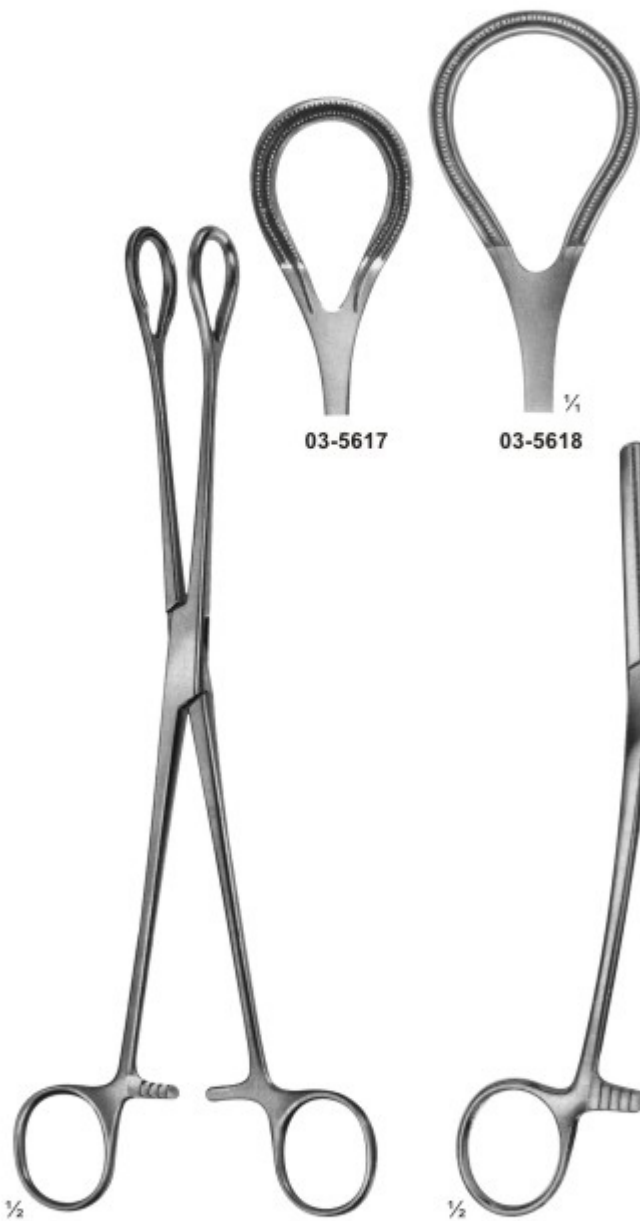

03-5617
250 mm
03-5618
270 mm

Pressure Clamp

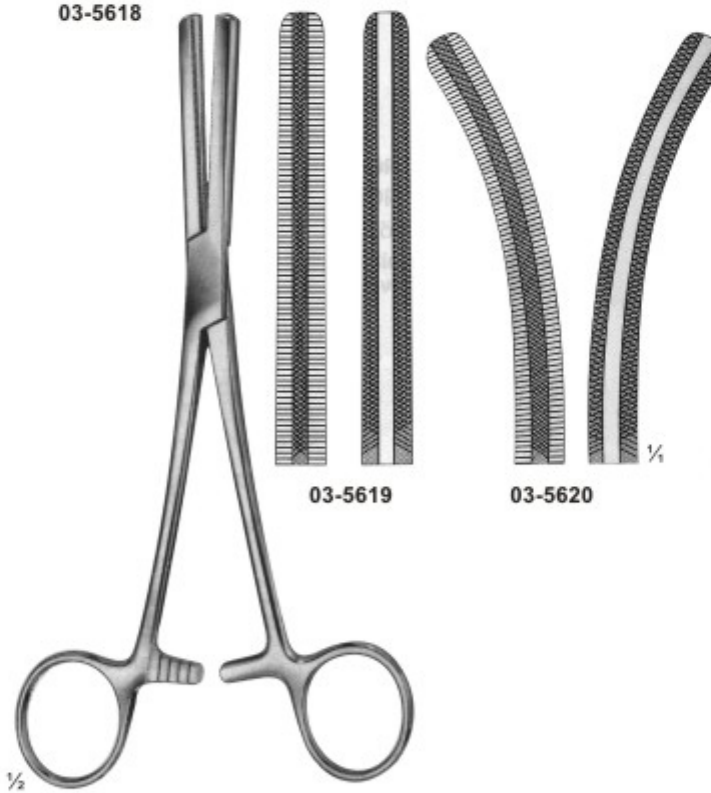

03-5619 - 03-5620
FERGUSSON
200 mm



03-5621
RUDD
Haemorrhoidal ligator
with loading
attachment and 100
ligature rubber rings
315 mm

Gall Duct Forceps



03-5622
LOWER
180 mm



03-5623
LAHEY (SWEET)
190 mm



03-5624
LAHEY
220 mm



03-5625
DESJARDINS
Gall duct-and cystic forceps
210 mm



03-5626
NISSEN
Gall duct-and cystic forceps
215 mm

Gall Duct Forceps and Choledochus Forceps

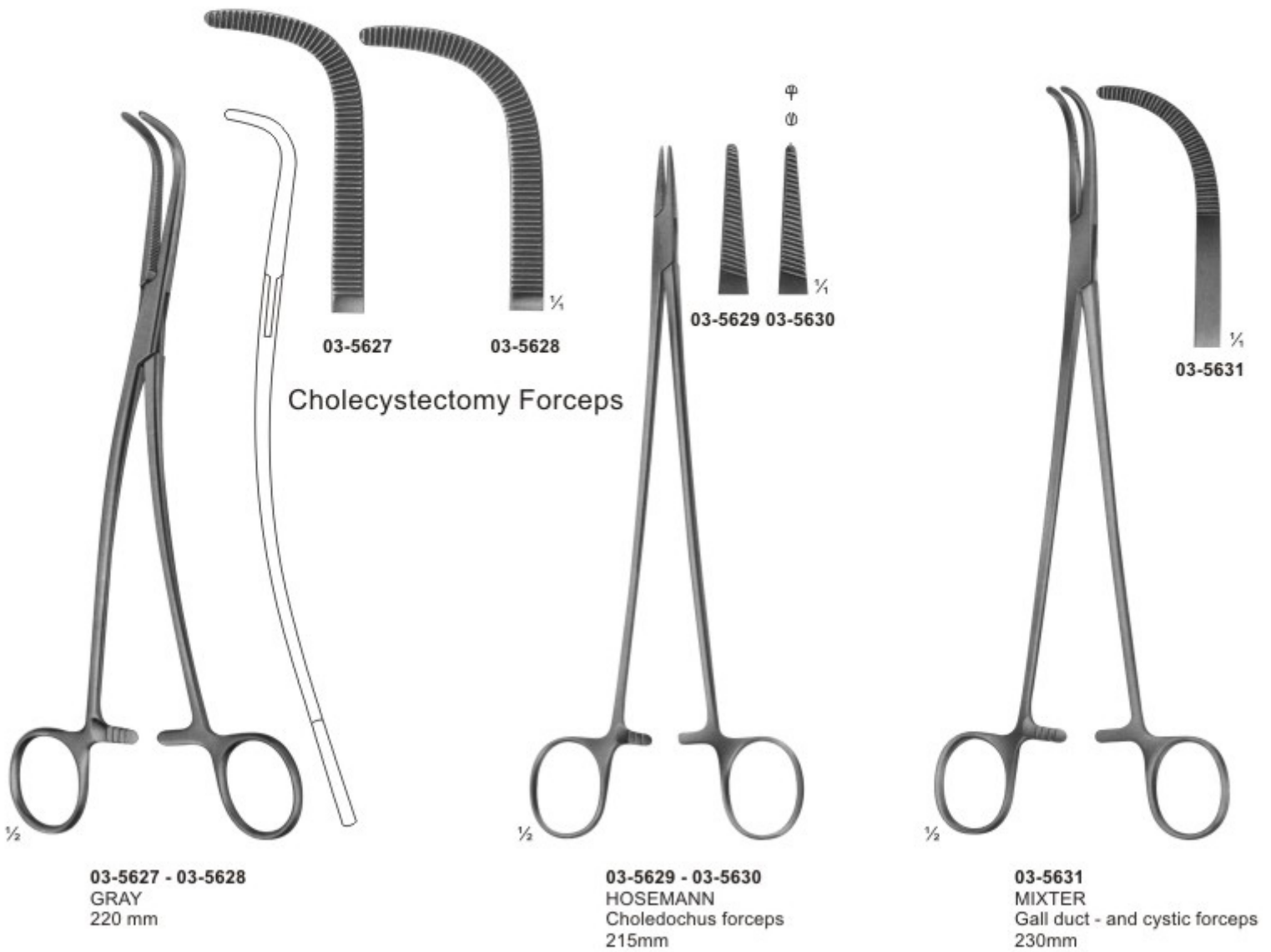

Gall Bladder Forceps and Gall Duct Scissors

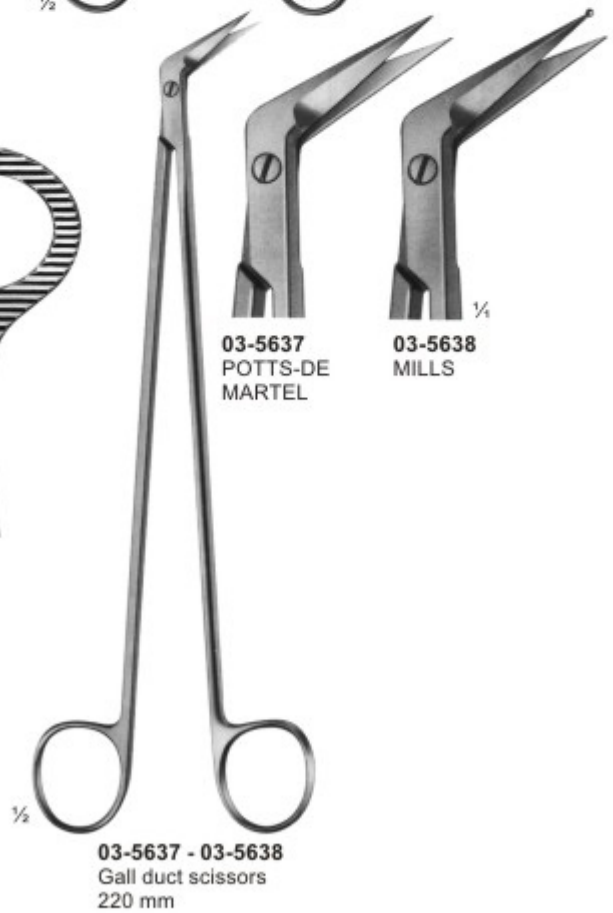
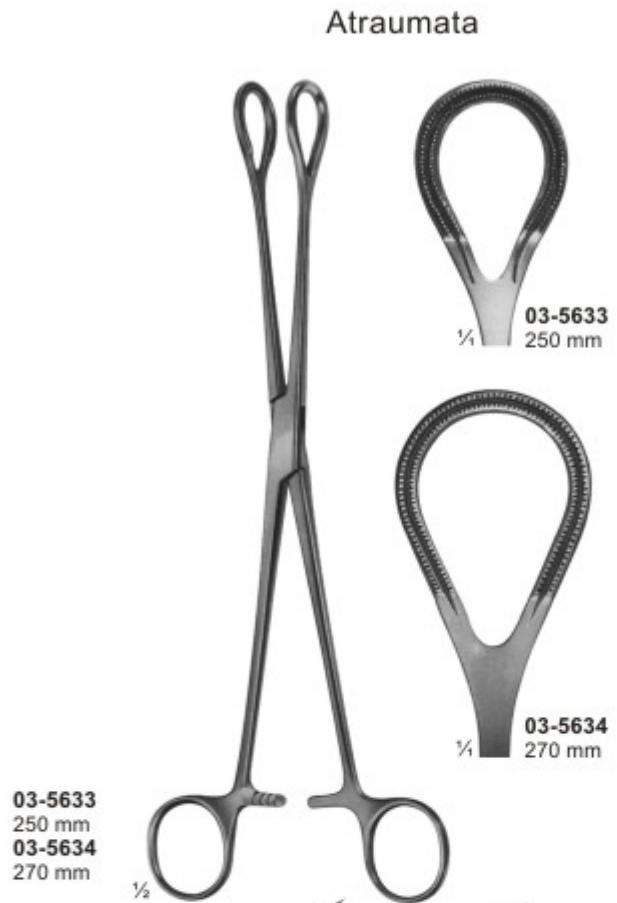
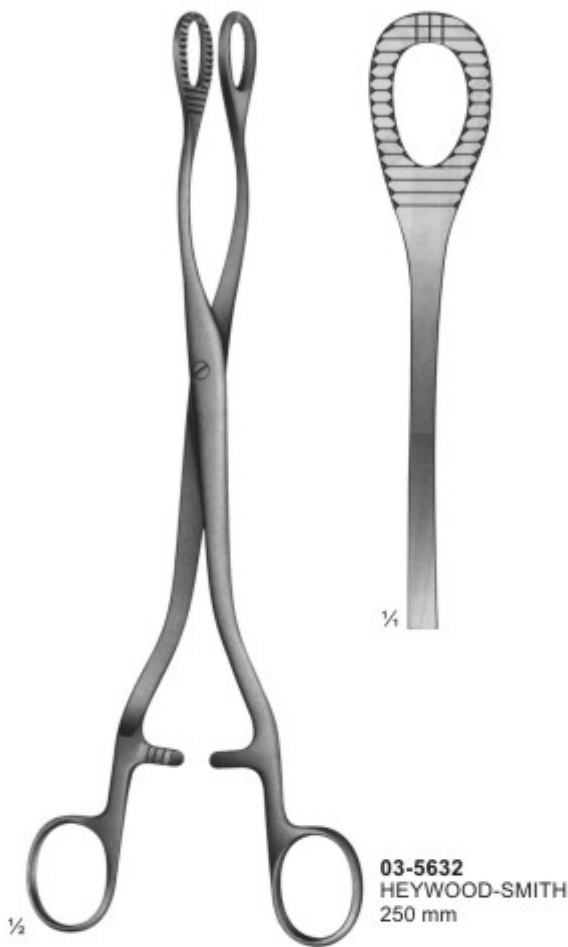

Gall Duct Dilators & Gall Stone Scoops

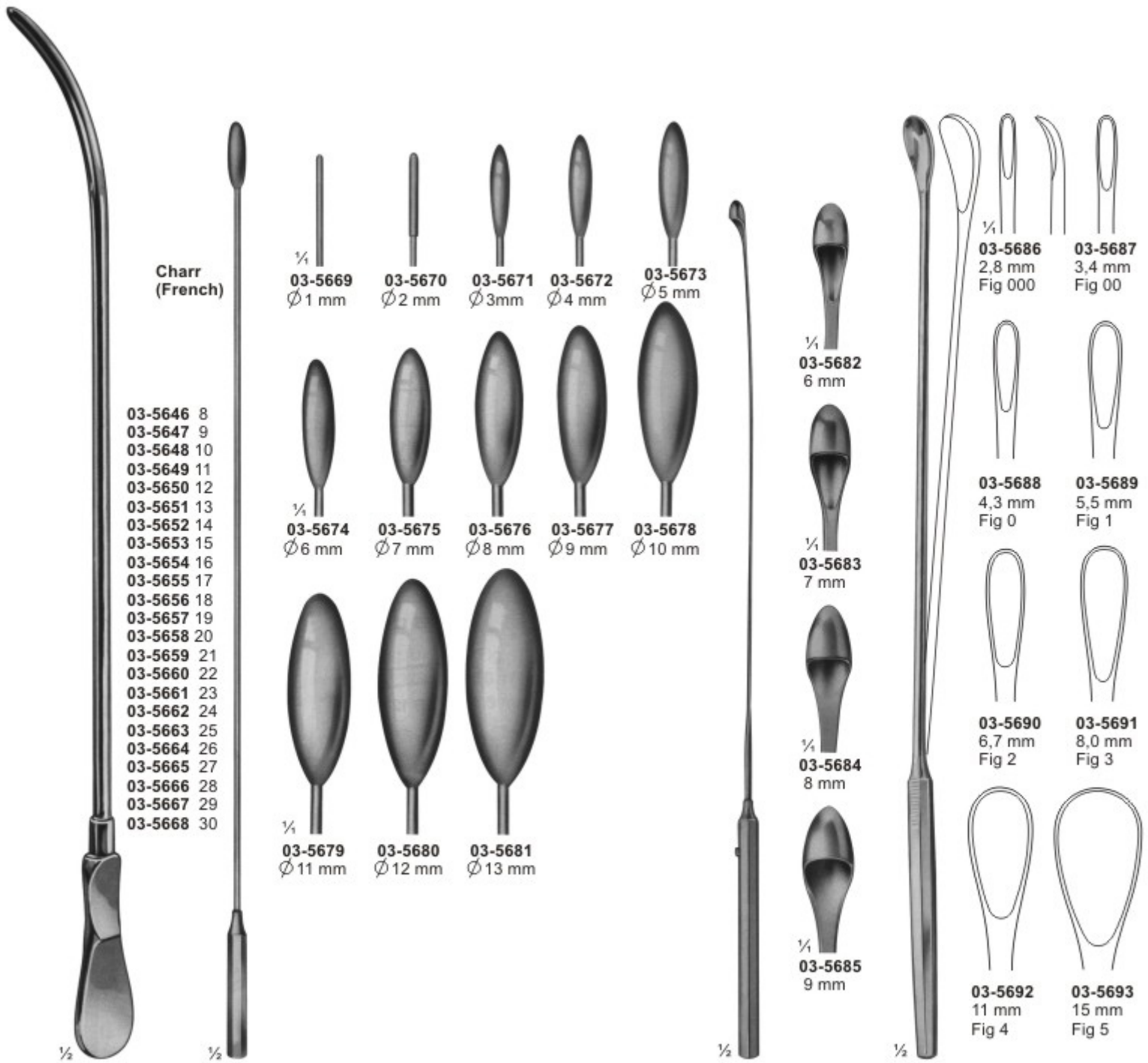

03-5646 - 03-5668
DITTEL
Metal bougies and dilating sounds, stiff 345 mm

03-5669 - 03-5681
BAKES
Common bile duct dilators, malleable
03-5669-03-5673 315mm
03-5674-03-5681 320mm
Set of 9 pieces (**03-5671-03-5679**) in canvas roll

03-5682 - 03-5685
DESJARDINS
Probes and catch with flexible shaft 300 mm

03-5686 - 03-5693
LUER-KOERTE
modif with malleable shaft 310 mm

Gall Stone Forceps

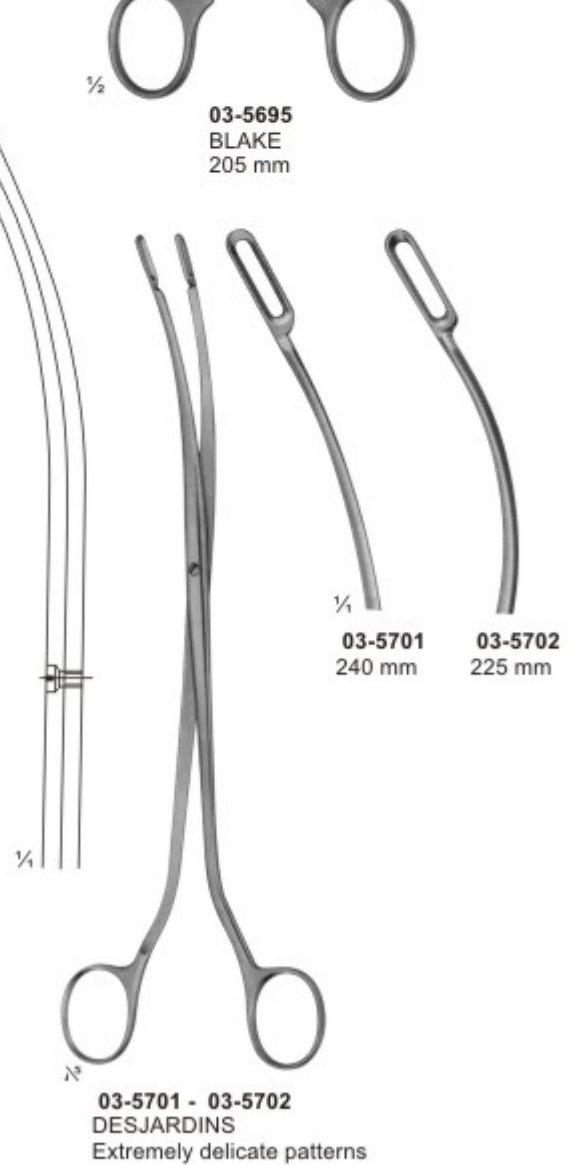
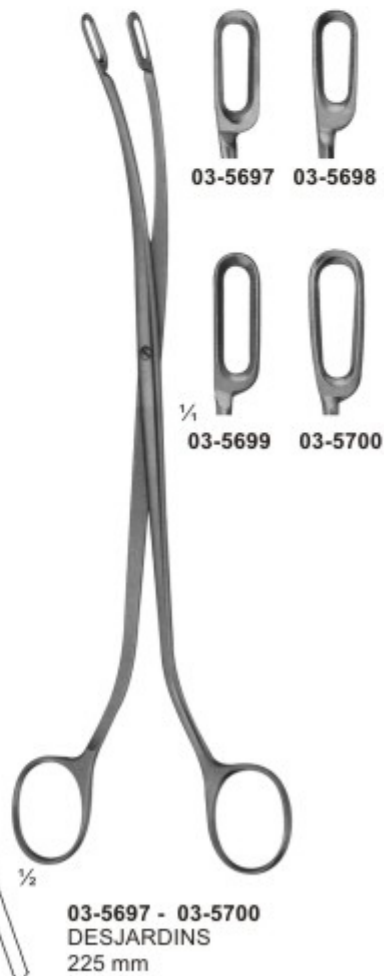
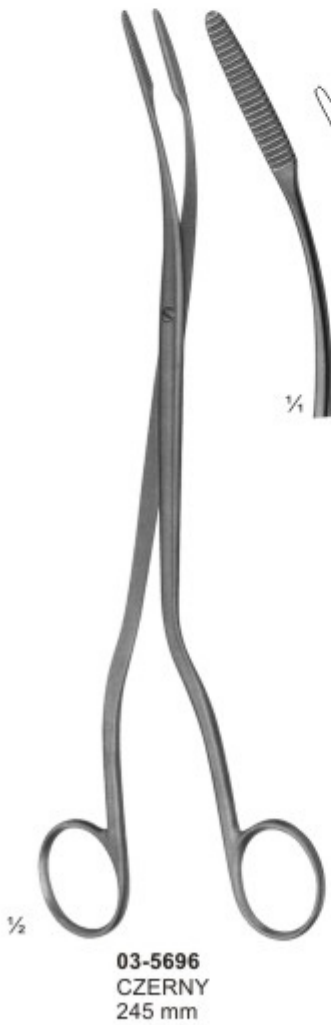

Kidney Clamps

Atraumata

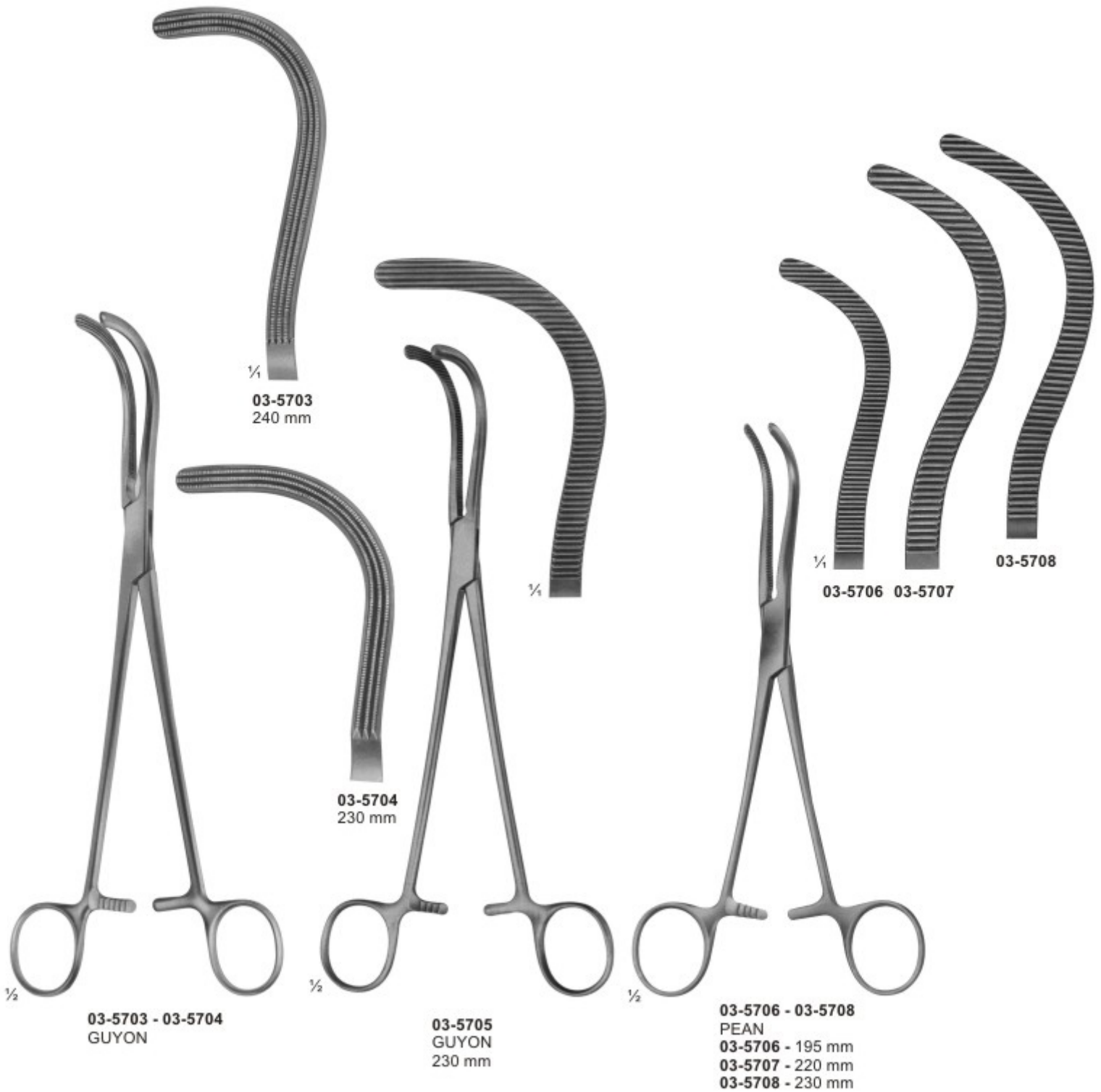

Kidney and Pedicle Clamps

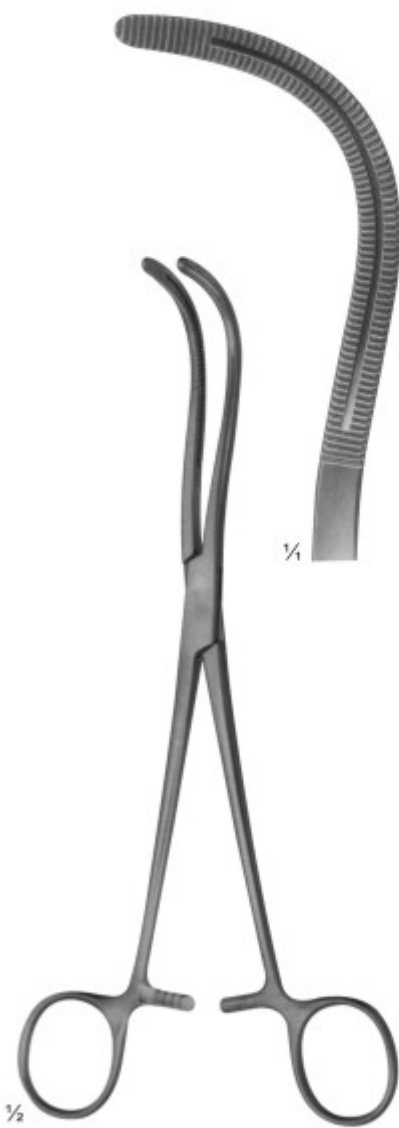

03-5709
STILLE
220 mm

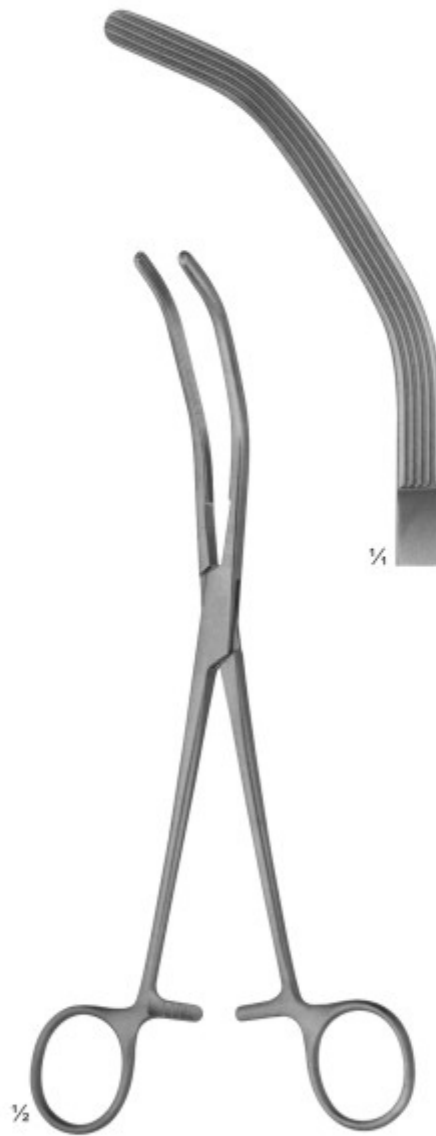

03-5710
HERRICK
225 mm



03-5711
WERTHEIM
225 mm

Kidney Elevating Forceps



03-5712
COLLIN
285 mm



03-5713
DARTIGUES
255 mm

Kidney Stone Forceps



03-5714 - 03-5717
RANDALL
225 mm



03-5718 - 03-5719
RANDALL
190 mm

Bladder Retractors

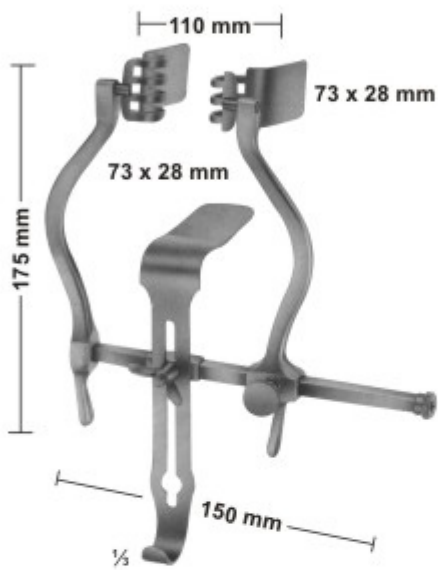

03-5720
JUDD-MASSON
Bladder-and suprapubic
retractor

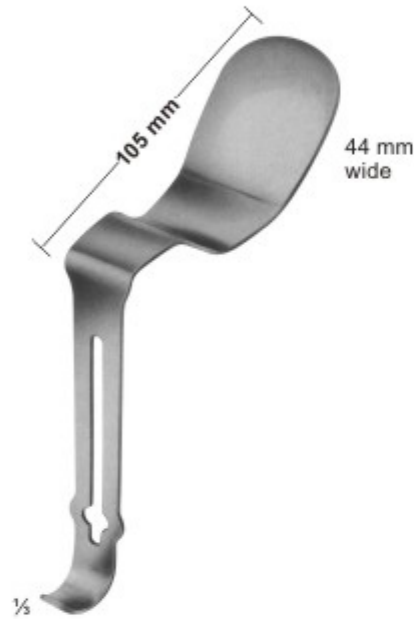

03-5721
MILLIN
Center blade for (05-6993)
retro pubic prostatectomy



03-5722
MILLIN
Bladder retractor
03-5722 Spreader only
03-5723 Blades 57x25mm
03-5724 Blades 82x25mm
03-5725 Center blade 105x45mm



03-5726
LEGUEU
Bladder retractor
Center blade
80 x 31 mm



03-5727
LEGUEU
Bladder spatula
260 mm



03-5728
KOCHER
Bladder spatula
235 mm

Genito-Urinary Instruments



03-5729
MATHIEU
Foreign body forceps
Length of shaft
190 mm

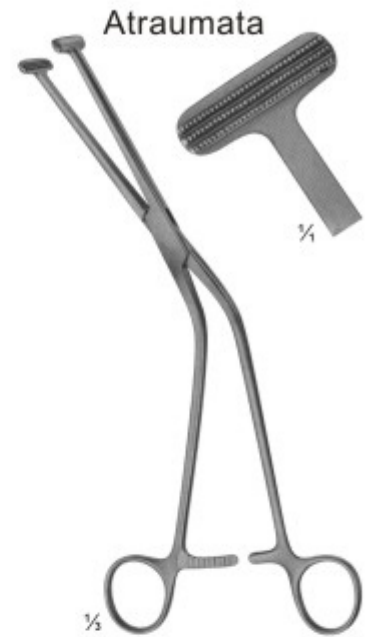

03-5730
MILLIN
Lobe grasping
forceps
235 mm

Atraumata

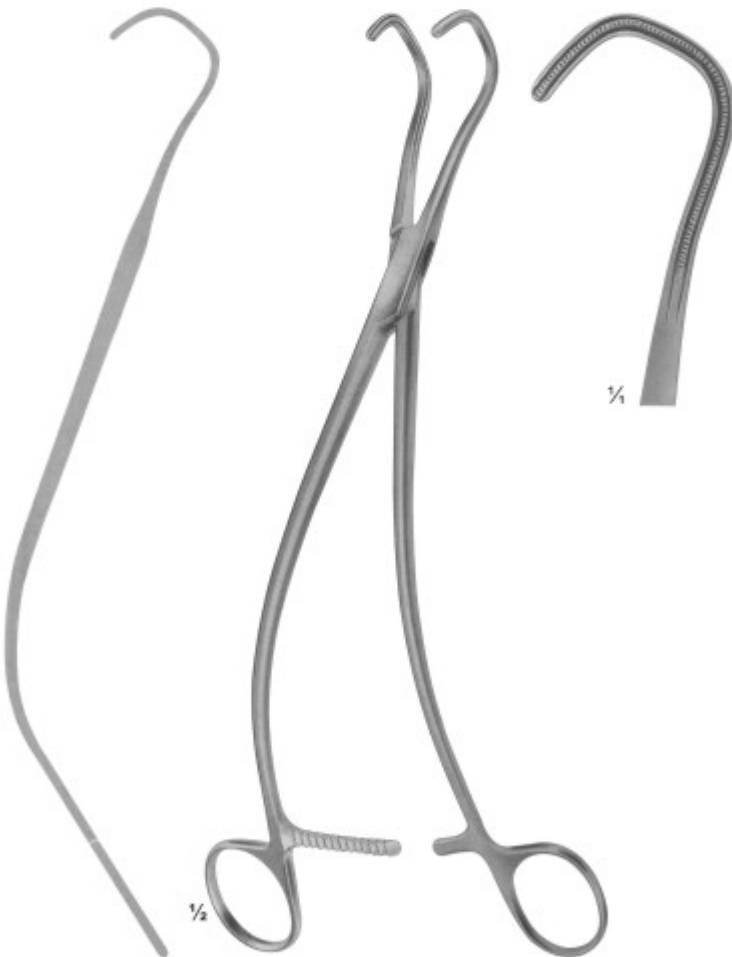

03-5731
Ureter forceps
240 mm

Atraumata

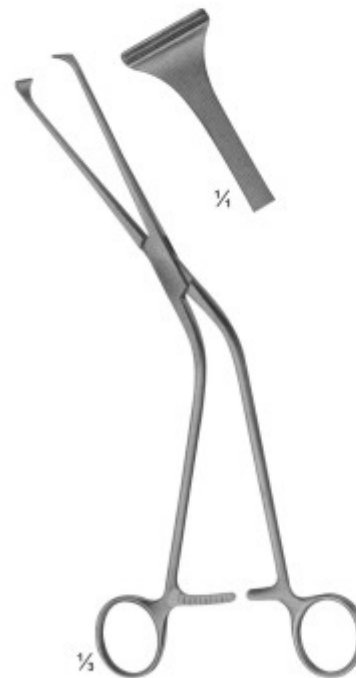

03-5732
MILLIN
Lobe grasping
forceps
245 mm



03-5733
MILLIN
Bladder neck spreader
285 mm

Genito-Urinary Instruments



03-5734
GUYON
Catheter guide
(introducer)
365 mm

**Charr.
(French)**

- 03-5735 6
- 03-5736 7
- 03-5737 8
- 03-5738 9
- 03-5739 10
- 03-5740 11
- 03-5741 12
- 03-5742 13
- 03-5743 14
- 03-5744 15
- 03-5745 16
- 03-5746 18
- 03-5747 20

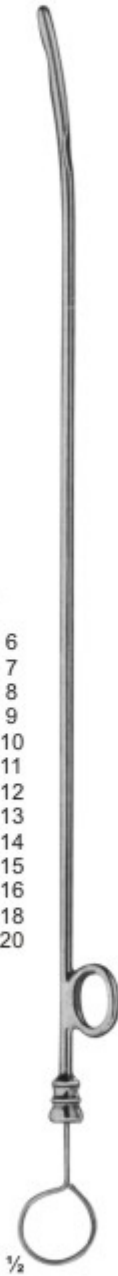

03-5735 - 03-5747
Female catheters,
metal
160 mm

**Charr.
(French)**

- 03-5748 8
- 03-5749 9
- 03-5750 10
- 03-5751 11
- 03-5752 12
- 03-5753 13
- 03-5754 14
- 03-5755 15
- 03-5756 16
- 03-5757 17
- 03-5758 18
- 03-5759 19
- 03-5760 20
- 03-5761 21
- 03-5762 22
- 03-5763 23
- 03-5764 24
- 03-5765 25
- 03-5766 26
- 03-5767 27
- 03-5768 28
- 03-5769 29
- 03-5770 30



03-5748 - 03-5770
DITTEL
Urethral bougies
and dilating sounds
345 mm

- 03-5771 Ben. 24/Charr. 12
- 03-5772 Ben. 25
- 03-5773 Ben. 26/Charr. 13
- 03-5774 Ben. 27
- 03-5775 Ben. 28/Charr. 14
- 03-5776 Ben. 29
- 03-5777 Ben. 30/Charr. 15
- 03-5778 Ben. 31
- 03-5779 Ben. 32/Charr. 16
- 03-5780 Ben. 33
- 03-5781 Ben. 34/Charr. 17
- 03-5782 Ben. 35
- 03-5783 Ben. 36/Charr. 18
- 03-5784 Ben. 37
- 03-5785 Ben. 38/Charr. 19
- 03-5786 Ben. 39
- 03-5787 Ben. 40/Charr. 20
- 03-5788 Ben. 41
- 03-5789 Ben. 42/Charr. 21
- 03-5790 Ben. 43
- 03-5791 Ben. 44/Charr. 22
- 03-5792 Ben. 45
- 03-5793 Ben. 46/Charr. 23
- 03-5794 Ben. 47
- 03-5795 Ben. 48/Charr. 24
- 03-5796 Ben. 49
- 03-5797 Ben. 50/Charr. 25
- 03-5798 Ben. 51
- 03-5799 Ben. 52/Charr. 26
- 03-5800 Ben. 53
- 03-5801 Ben. 54/Charr. 27
- 03-5802 Ben. 55
- 03-5803 Ben. 56/Charr. 28
- 03-5804 Ben. 57
- 03-5805 Ben. 58/Charr. 29
- 03-5806 Ben. 59
- 03-5807 Ben. 60/Charr. 30

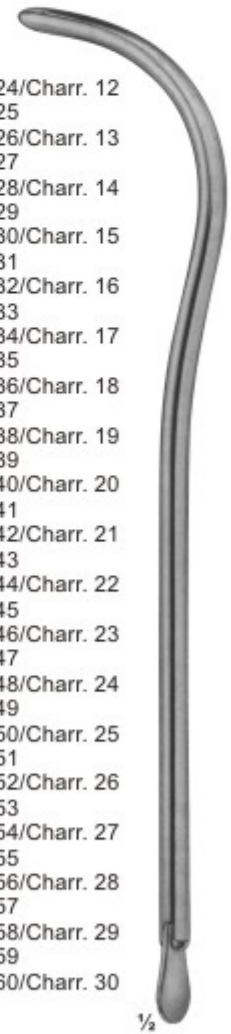

03-5771 - 03-5807
GUYON
Urethral bougies
and dilating sounds,
without filiform guides,
with thread in tip
255 mm

Genito-Urinary Instruments & Circumcision Clamps



03-5808
GUYON
 Set of urethral bougies and dilating sounds, in metal case, with lift out rack and bottom rack, containing 21 urethral and dilating sounds, metal.



03-5809 - 03-5811
WINKELMANN
03-5809 ∅ 12mm
03-5810 ∅ 16mm
03-5811 ∅ 20mm

Circumcision Clamps

Assisted by two haemostats or ligatures the foreskin is pushed over the bellshaped protection - rod and the glans is placed into it. By now, the wing - nut is tightened as close as possible, so the foreskin in annular compressed. The foreskin is cut of with a scalpel, right next to the compression ring. The circumcision clamp remains a few minutes to avoid bleeding. In case that any large vein, specially the frenular artery, is cut through, a ligature must be set. The advantage of the method described is the cosmetically favourable scar which is left after rejection of the small necrotized portion.

Trocars



Luer Lock

03-5812
KLIMA ROSEGGER
35 X 1,8 mm
Sternal puncture needle

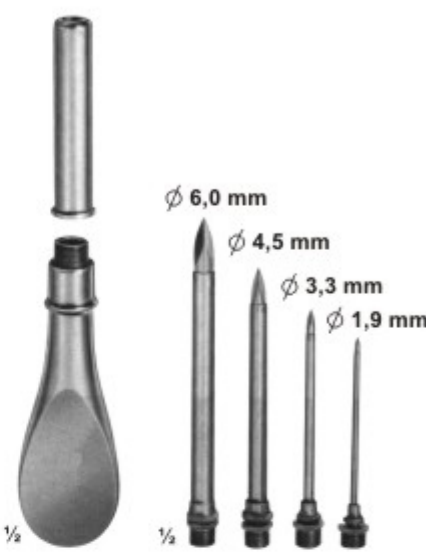

03-5813
Universal trocar
with 4 tips

Ø 6,0 mm
Ø 4,5 mm
Ø 3,3 mm
Ø 1,9 mm



03-5814 - 03-5818
NELSON

	Inside diam	Outside diam
03-5814	2,2 mm	3,0 mm
03-5815	3,0 mm	4,0 mm
03-5816	4,0 mm	5,0 mm
03-5817	5,0 mm	6,0 mm
03-5818	5,5 mm	6,5 mm

for hydrocele and abdominal puncture



03-5819 - 03-5822

	Inside diam	Outside diam
03-5819	2,2 mm	3,0 mm
03-5820	3,0 mm	4,0 mm
03-5821	4,0 mm	5,0 mm
03-5822	5,0 mm	6,0 mm

for abdominal puncture,
with stop-cock and lateral drain

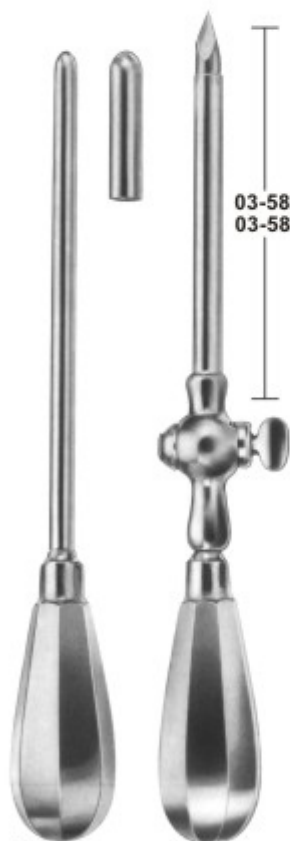

03-5823 100 mm
03-5824 110 mm

03-5823 - 03-5824
BUELAU

	Inside diam	Outside diam
03-5823	6,5 mm	8,0 mm
03-5824	9,0 mm	10,0 mm

Empyema trocar

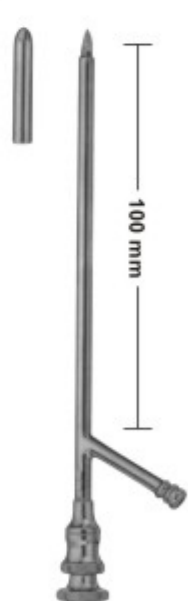

03-5825 - 03-5828
OCHSNER

	Inside diam	Outside diam
03-5825	3,0 mm	4,0 mm
03-5826	3,6 mm	4,6 mm
03-5827	4,3 mm	5,3 mm
03-5828	5,0 mm	6,0 mm

Gall bladder trocars



Record Cone 1

03-5829
PIERCE
Antrum trocar
Ø 4,0 mm



Luer Lock Cone

03-5830
COAKLEY
Antrum trocar
Ø 3,0 mm

Vaginal specula

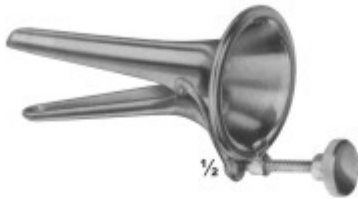

04-6001
COLLIN
for children
53 x 10 mm

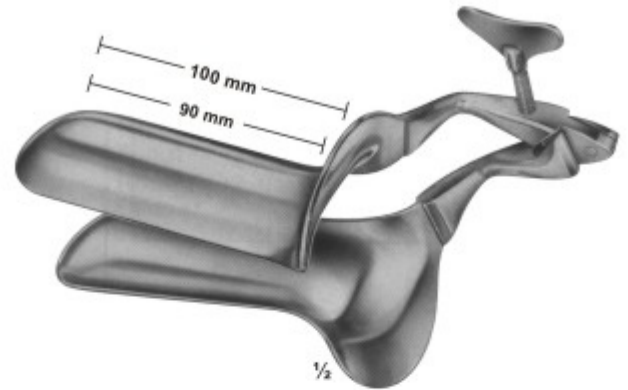

04-6002 - 04-6005
COLLIN

04-6002	100/90mm	28 mm
04-6003	100/90mm	32 mm
04-6004	105/95mm	35 mm
04-6005	115/105mm	40 mm

 Total length/working length width

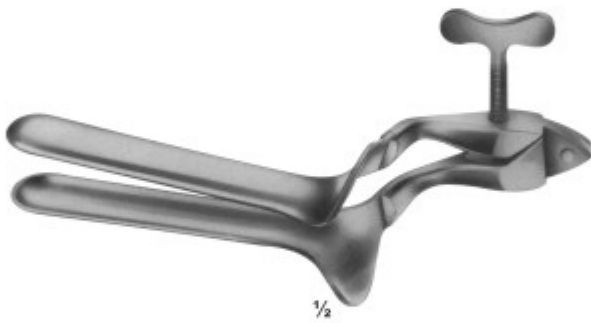

04-6006
COLLIN
for virgins
95/85 x 18 mm



04-6007
CUSCO
for virgins
75 x 17 mm

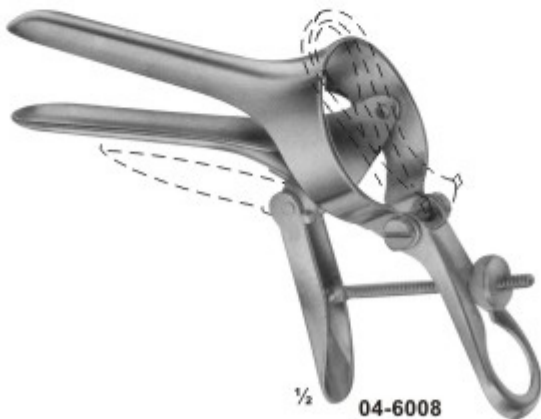

04-6008
CUSCO
for virgins
75 x 17 mm



04-6009 - 04-6011
CUSCO
Swiss patterns features:
long and narrow

04-6009	92X23-25 mm
04-6010	100x25-27 mm
04-6011	110x27-30 mm

Vaginal Specula



04-6012 - 04-6015
CUSCO
STANDARD
04-6012 80X24 mm
04-6013 80X32 mm
04-6014 90X36 mm
04-6015 110X37 mm

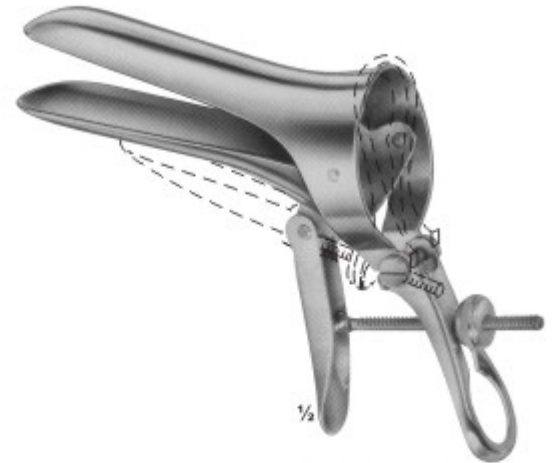

04-6016 - 04-6019
CUSCO
04-6016 80X24 mm
04-6017 80X32 mm
04-6018 90X36 mm
04-6019 110X37 mm



Flat (duck beak)

04-6020 - 04-6022
CUSCO
04-6020 80X32 mm
04-6021 90X37 mm
04-6022 115X37 mm



04-6023 - 04-6024
SEYFFERT
04-6023 100X17 mm
04-6024 110X33 mm
230 mm



With double ratchet, closing and opening of ratchet by pressure of thumb

04-6025
SEMM
for children and virgins
180 mm
90X14-18mm

Vaginal Specula, Sets, Upper & Lower Blades



04-6026 - 04-6028
GRAVE
04-6026 75X20 mm
04-6027 95X30 mm
04-6028 105X33 mm



04-6029 - 04-6030
PEDERSON
04-6029 100X22 mm
04-6030 120X25 mm

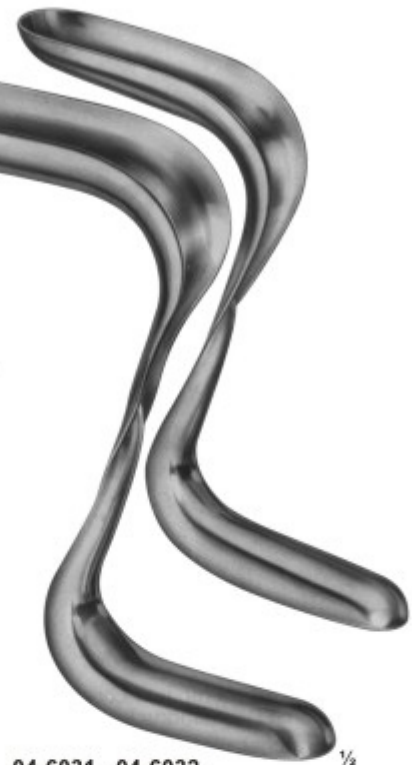

04-6031 - 04-6032
BRIESKY
04-6031 72X25 mm / 77X30 mm 140mm
04-6032 75X30 mm / 92X38 mm 170mm



04-6033 - 04-6035
SIMS
04-6033 70X26 mm / 75 X30 mm
125 mm
04-6034 75X30 mm / 80X35 mm
150 mm
04-6035 80X36 mm / 90X40mm
175mm



04-6036 - 04-6038
SEIDL
04-6036 80X8 mm
04-6037 80X10 mm
04-6038 90X14 mm
For children and infants
170 mm



04-6039
KRISTELLER
70X15 mm, (170 mm)
For children



04-6040 - 04-6042
KRISTELLER
04-6040 70X27 mm
04-6041 75X30 mm
04-6042 90X36 mm
175 mm

Vaginal Specula-Sets, upper and lower blades



Vaginal Specula-upper and lower blades

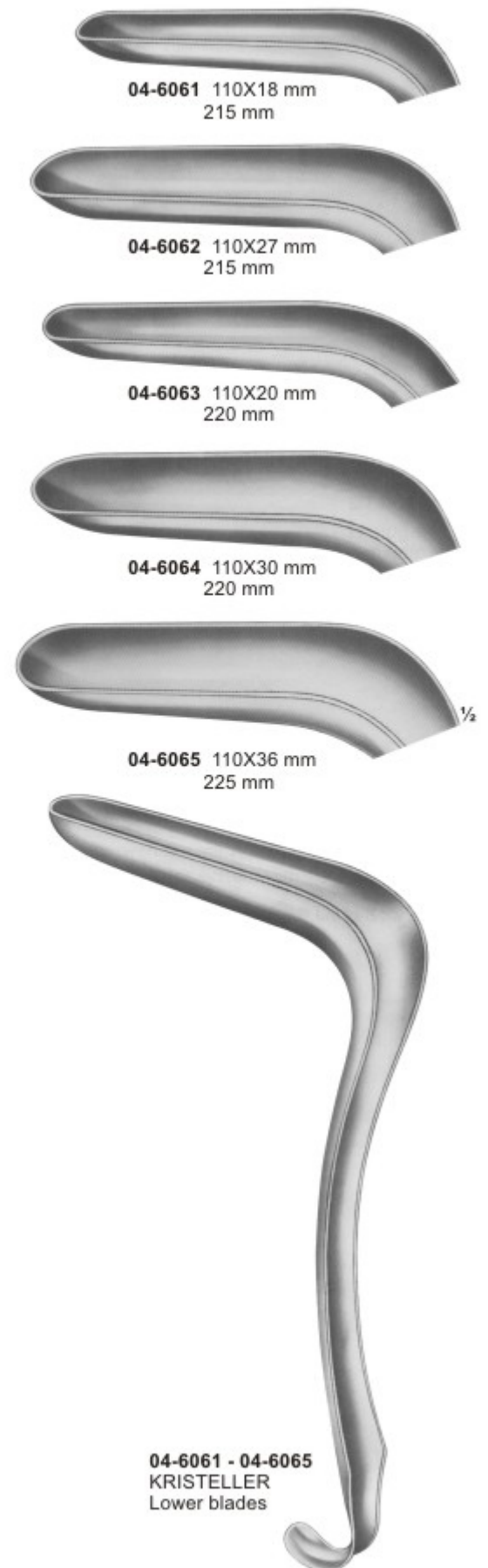
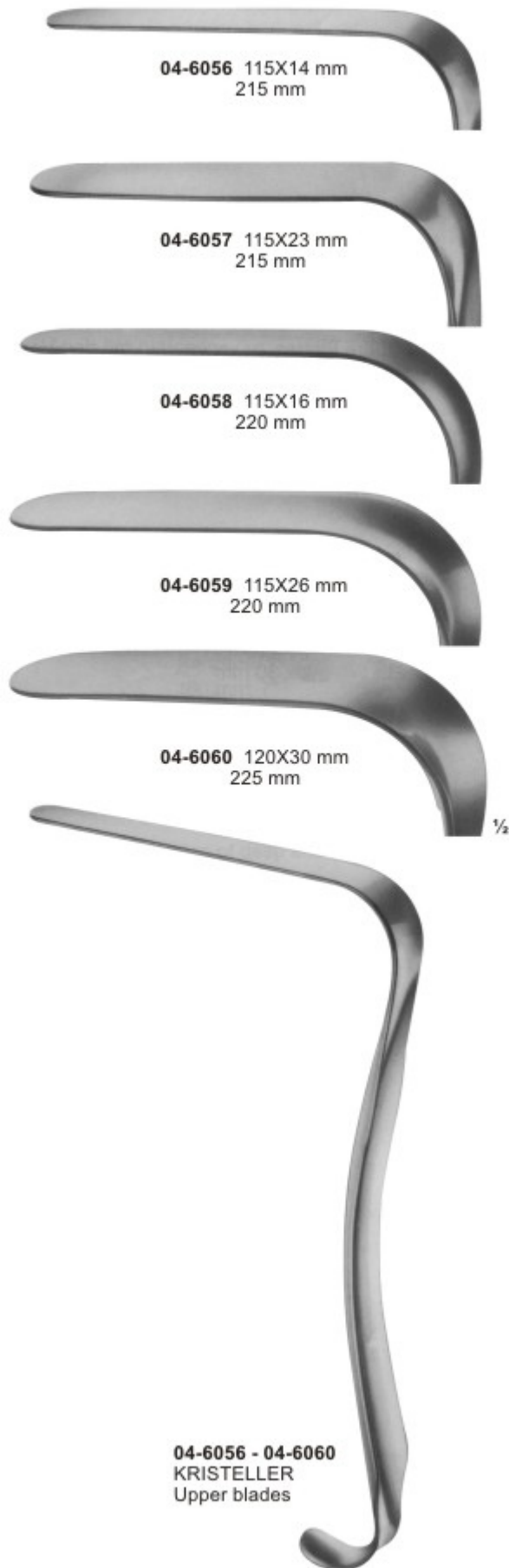

Vaginal Specula



04-6066
80 X 28 mm



04-6069
76 X 38 mm



04-6067
85 X 35 mm



04-6070
89 X 38 mm



04-6068
85 X 40 mm



04-6071
102 X 38 mm



Slightly Concave

1/2

04-6066 - 04-6068
KRISTELLER
205 mm



Slightly Concave

1/2

04-6069 - 04-6071
JACKSON
175 mm

Vaginal Specula-for children & virgins

Vario Retractor

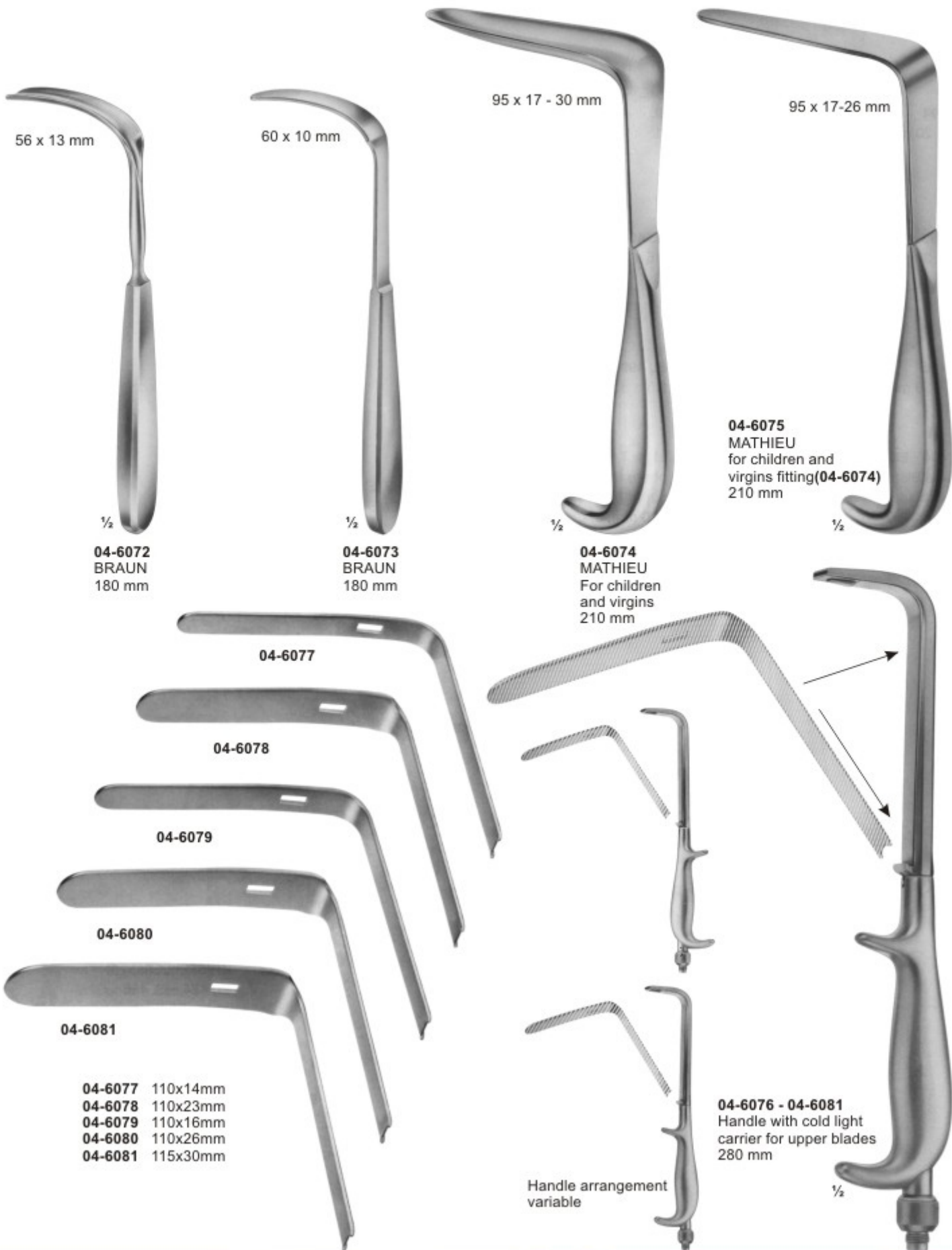

Vaginal Specula-for children and virgins



04-6082 - 04-6084
DOYEN
235 mm

Length of blades	Width of blades			DOYEN
	35 mm	45 mm	60 mm	
60 mm	04-6085	04-6088	04-6091	04-6085 - 04-6094 DOYEN 240mm
90 mm	04-6086	04-6089	04-6092	
120 mm	04-6087	04-6090	04-6093	
160 mm		04-6090A	04-6094	

Vaginal Specula / Retractors



04-6095 - 04-6099
BREISKY
WIENER MODELL/
VIENNA PATTERN
04-6095 100 X 20 mm
04-6096 100 X 25 mm
04-6097 100 X 30 mm
04-6098 100 X 35 mm
04-6099 100 X 40 mm
300 mm

04-6100 - 04-6104
BREISKY
WIENER MODELL/
VIENNA PATTERN
04-6100 130 X 20 mm
04-6101 130 X 25 mm
04-6102 130 X 30 mm
04-6103 130 X 35 mm
04-6104 130 X 40 mm
320 mm

04-6107
removable strainer only

04-6105 - 04-6106
WEISSBARTH
04-6105 80 X 28 mm
04-6106 85 X 42 mm
210 mm

04-6108
DOYEN
lateral speculum
80 x 30 mm
250 mm

Vaginal & Wound Retractor / Vaginal Specula



04-6109 - 04-6110
SIMON
115 X 22 mm
275 mm



04-6110
115 X 26 mm
275 mm

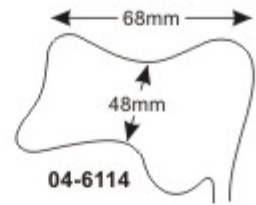

04-6114

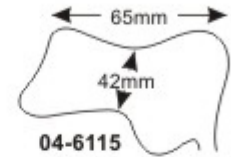

04-6115

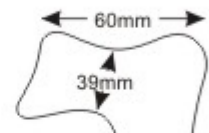

04-6116

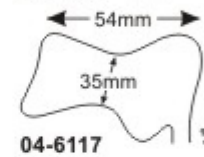

04-6117



04-6111
AUVARD
65 X 38 mm - 28 mm
1,530 kg = 3 lbs
with fixed weight
230 mm

04-6112 - 04-6113
AUVARD
04-6112 75 X 42-40 mm
04-6113 105 X 43-40 mm
1,470 kg = 3 lbs
with detachable weight
230 mm



04-6114 - 04-6117
MARTIN
with hook shaped
handle for hanging
in weights
270 mm



Vaginal Speculas

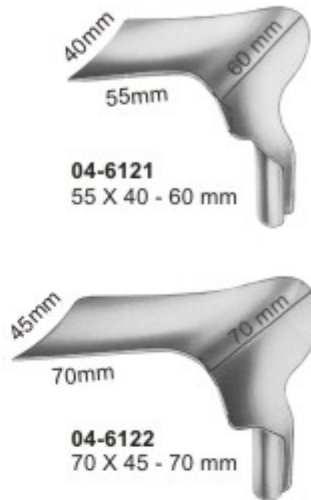

The mentioned blades (04-6118 - 04-6122 and 04-6125 - 04-6132) can be exchanged. They fit handle (04-6123), as well as handles (04-6133 and 04-6134).

04-6118 - 04-6124
SCHERBACK
Set consisting of:
handle 04-6123
weight 04-6124
4 blades 04-6118 - 04-6121



04-6133
BOZEMANN
Set consisting of:
2 handle (04-6133 - 04-6134)
8 blades(04-6125 - 04-6132)

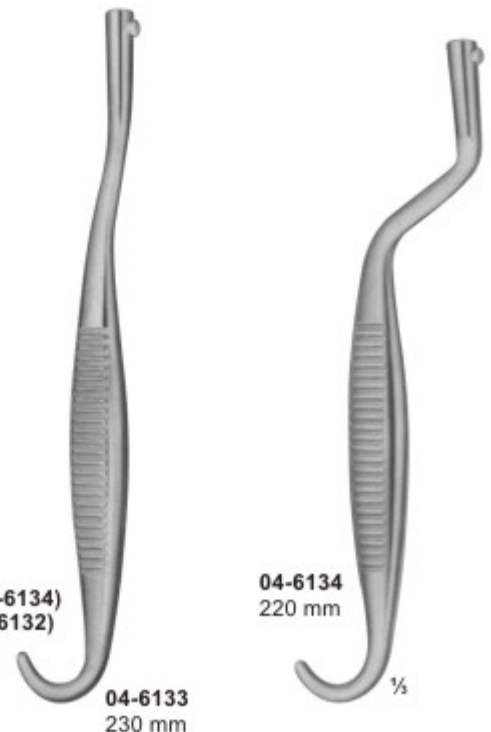

Vaginal Retractors



1/2
04-6135
JOLL (FRIEDMAN)
155 mm



1/2
04-6136
RICHTER
170 mm



1/2
04-6137
GELPI
135 mm



1/2
04-6138
GELPI
175 mm

Uterine Dilators



1/2

04-6139 - 04-6181
HEGAR
with very conical point
185 mm

04-6139	1	mm	04-6161	23	mm
04-6140	2	mm	04-6162	24	mm
04-6141	3	mm	04-6163	25	mm
04-6142	4	mm	04-6164	26	mm
04-6143	5	mm	04-6165	1	1/2mm
04-6144	6	mm	04-6166	2	1/2mm
04-6145	7	mm	04-6167	3	1/2mm
04-6146	8	mm	04-6168	4	1/2mm
04-6147	9	mm	04-6169	5	1/2mm
04-6148	10	mm	04-6170	6	1/2mm
04-6149	11	mm	04-6171	7	1/2mm
04-6150	12	mm	04-6172	8	1/2mm
04-6151	13	mm	04-6173	9	1/2mm
04-6152	14	mm	04-6174	10	1/2mm
04-6153	15	mm	04-6175	11	1/2mm
04-6154	16	mm	04-6176	12	1/2mm
04-6155	17	mm	04-6177	13	1/2mm
04-6156	18	mm	04-6178	14	1/2mm
04-6157	19	mm	04-6179	15	1/2mm
04-6158	20	mm	04-6180	16	1/2mm
04-6159	21	mm	04-6181	17	1/2mm
04-6160	22	mm			



1/2

04-6182 - 04-6190
HEGAR
205 mm

04-6182	1+2	mm
04-6183	3+4	mm
04-6184	5+6	mm
04-6185	7+8	mm
04-6186	9+10	mm
04-6187	11+12	mm
04-6188	13+14	mm
04-6189	15+16	mm
04-6190	17+18	mm

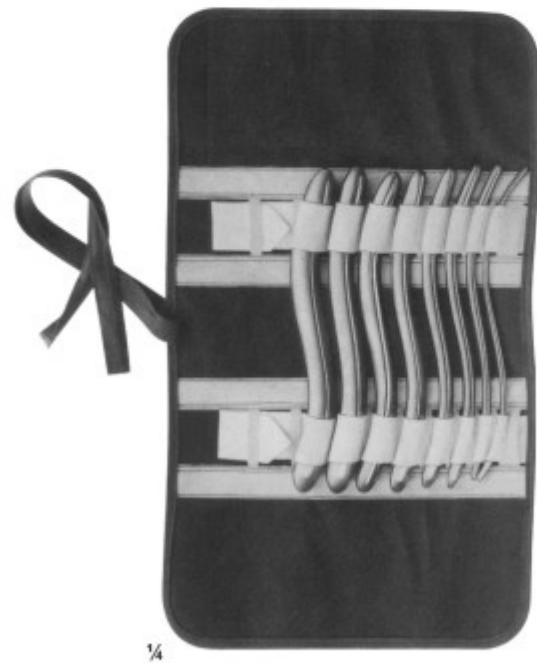

1/4

04-6191
HEGAR
Uterine dilator set, in canvas roll
with 8 dilators.

Uterine Dilators - Complete Sets



04-6192
HEGAR
Dilator set consisting of:
14 Dilators,
(04-6193) 1 Rack for dilators (4 - 12 mm)
(04-6194) 1 Rack for Dilators (13 - 17 mm)
(04-6195) 1 Metal case only,
with hinged lid, stainless 200 X 100 X 35 mm

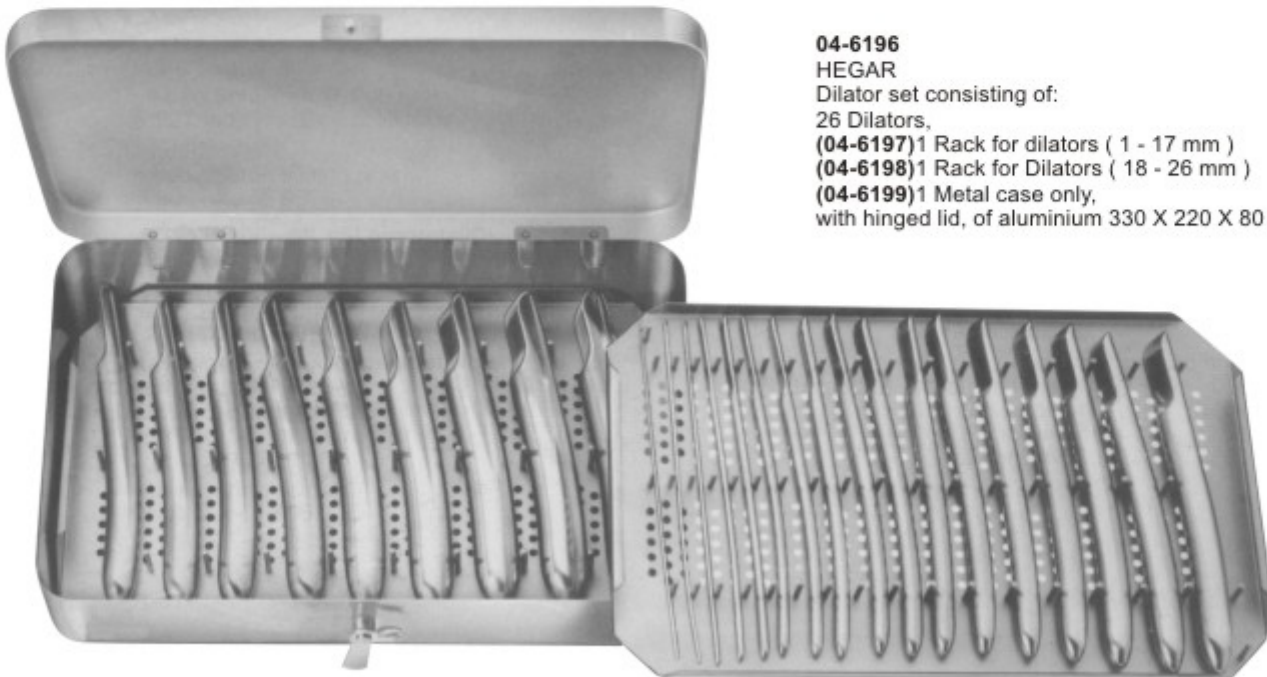

04-6196
HEGAR
Dilator set consisting of:
26 Dilators,
(04-6197) 1 Rack for dilators (1 - 17 mm)
(04-6198) 1 Rack for Dilators (18 - 26 mm)
(04-6199) 1 Metal case only,
with hinged lid, of aluminium 330 X 220 X 80 mm

Endospecula For Cervix

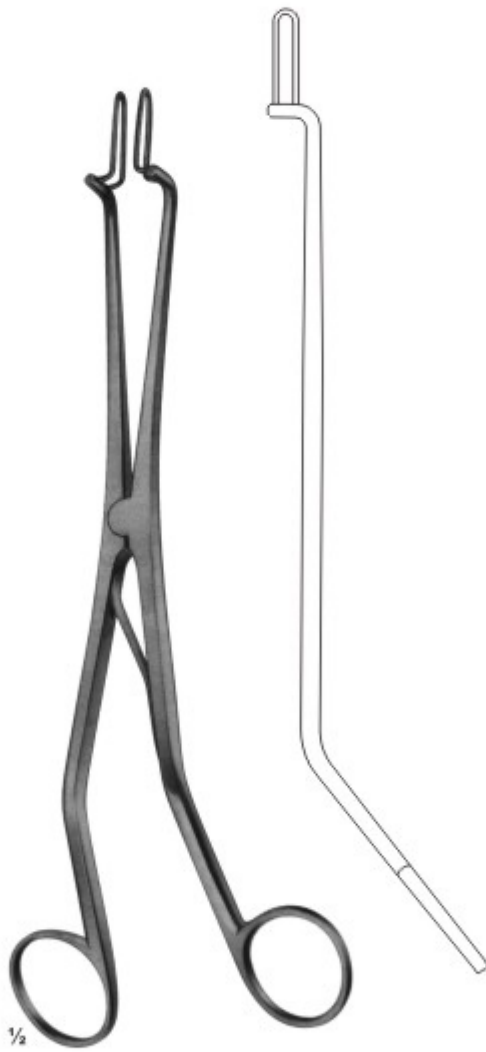

04-6200
KOGAN
Endospecula for cervix
and urethra, without ratchet
240 mm



04-6201
KOGAN
Endospecula for cervix
and urethra, with
scale-ratchet and fixing screws
240 mm

Uterine Probes

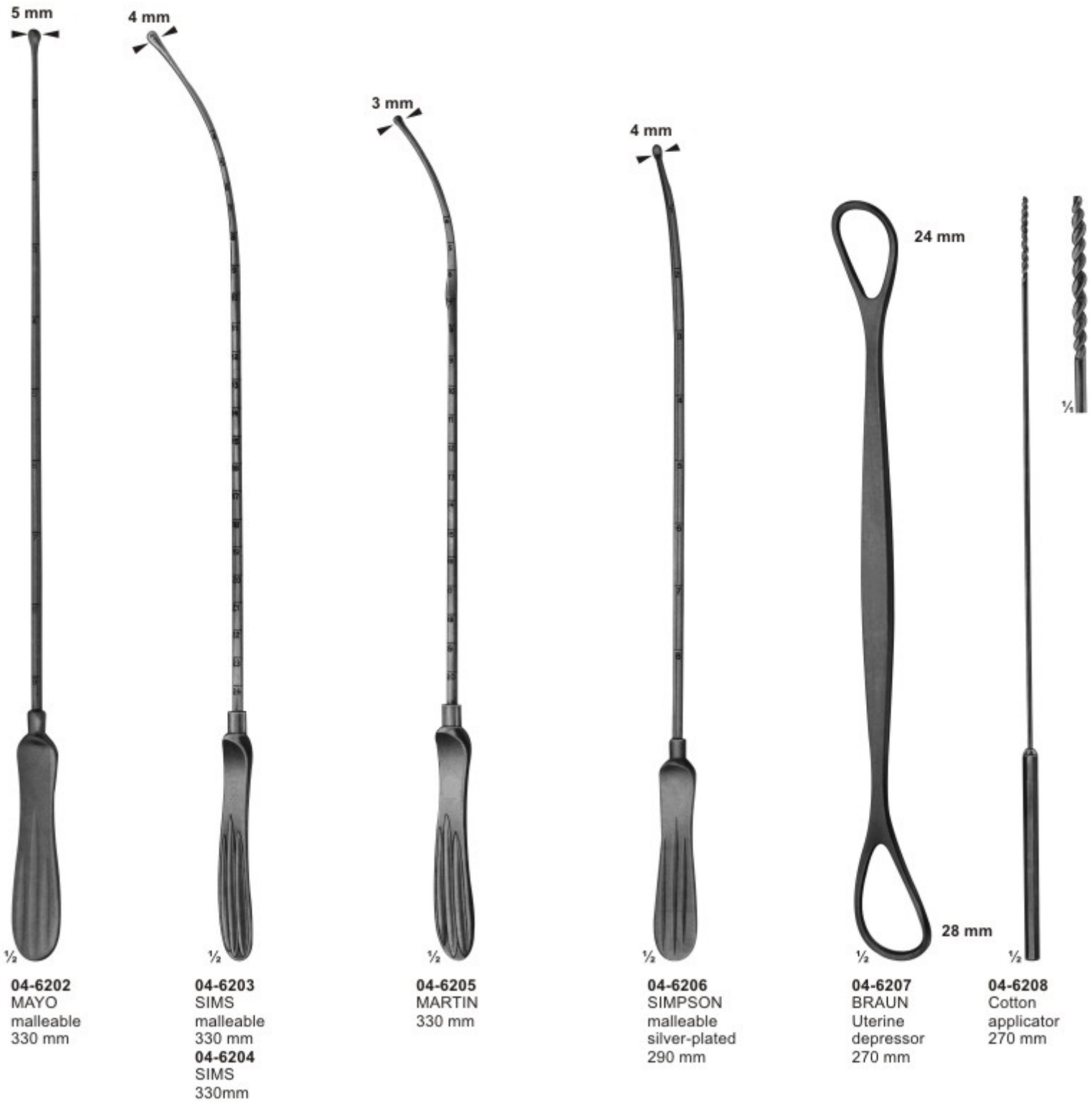

Uterine Dressing Forceps



04-6209
PELKMANN
260 mm



04-6210
PELKMANN
260 mm

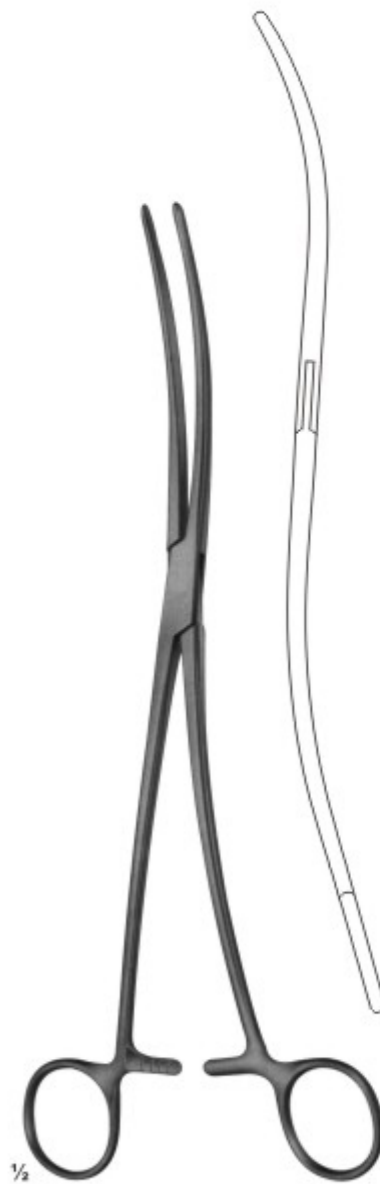

04-6211
BOZEMANN
250 mm

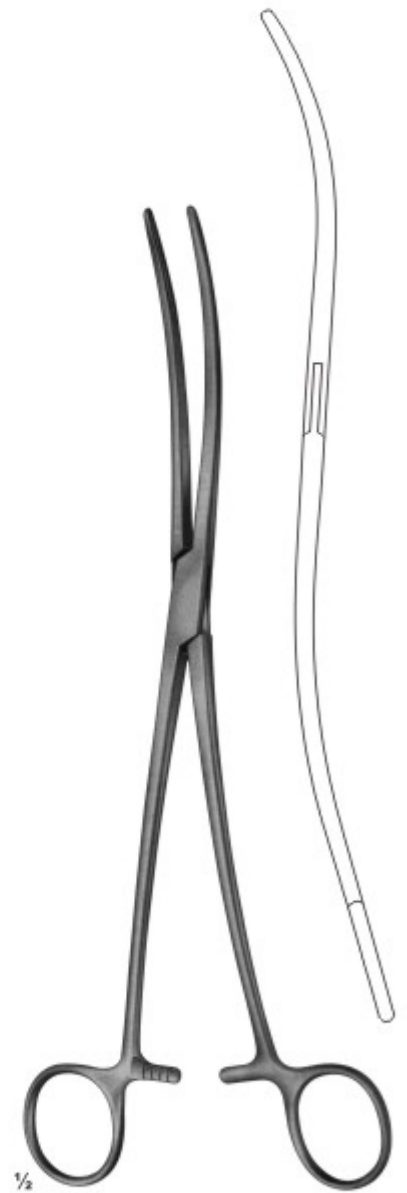

04-6212
BOZEMANN
255 mm

Jaws with longitudinal groove

Uterine Dressing Forceps

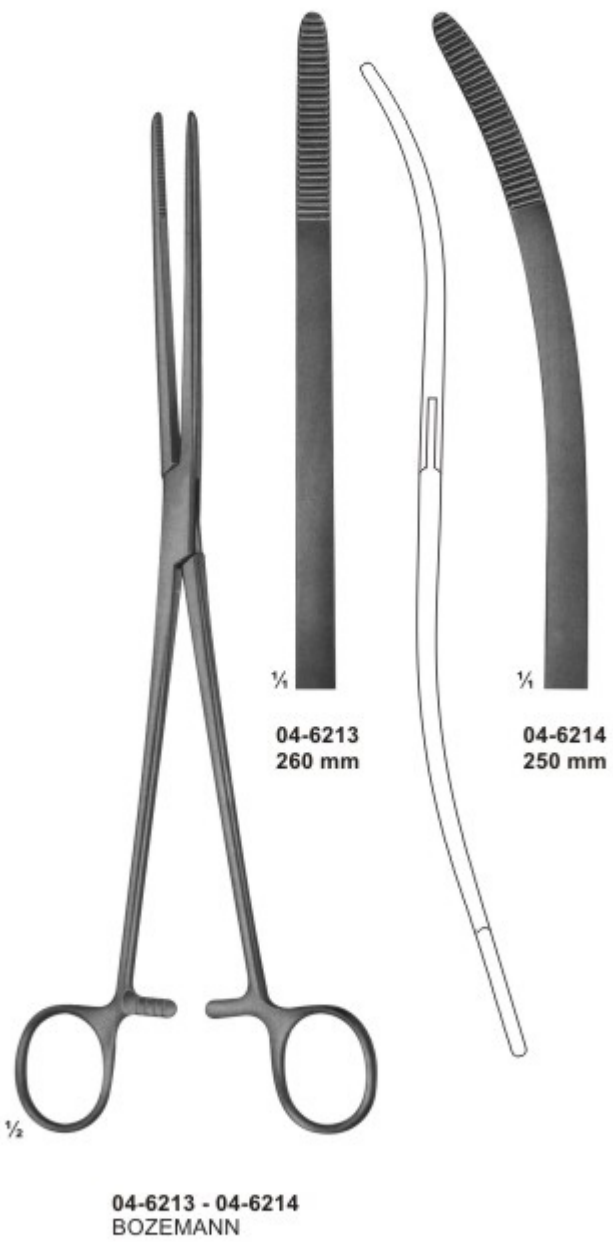

Uterine Tenaculum Forceps

Standard



04-6216
BRAUN
slender type
250 mm



04-6217
SCHROEDER
250 mm



04-6218
POZZI
heavy type
255 mm

Uterine Tenaculum Forceps



04-6219
MARTIN
265 mm

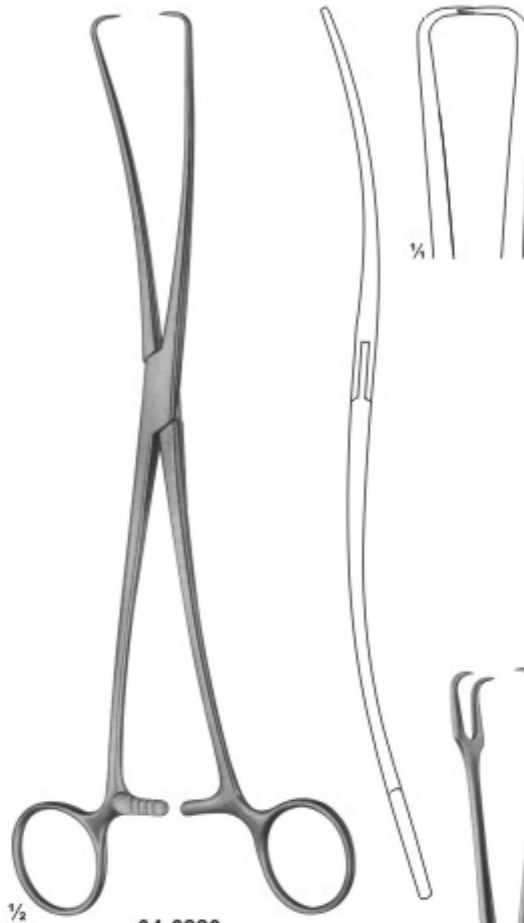

04-6220
DUPLAY
250 mm

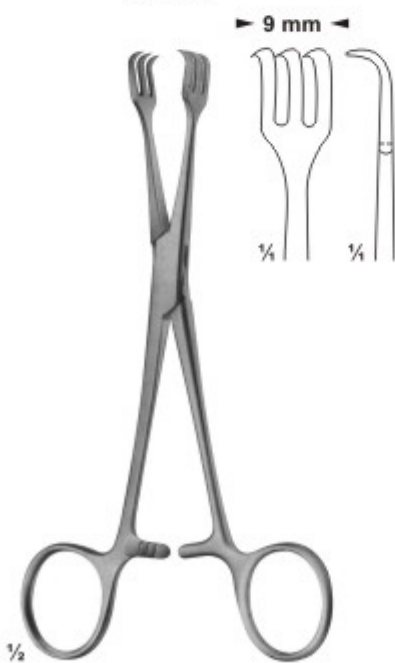

04-6221
LAHEY
155 mm

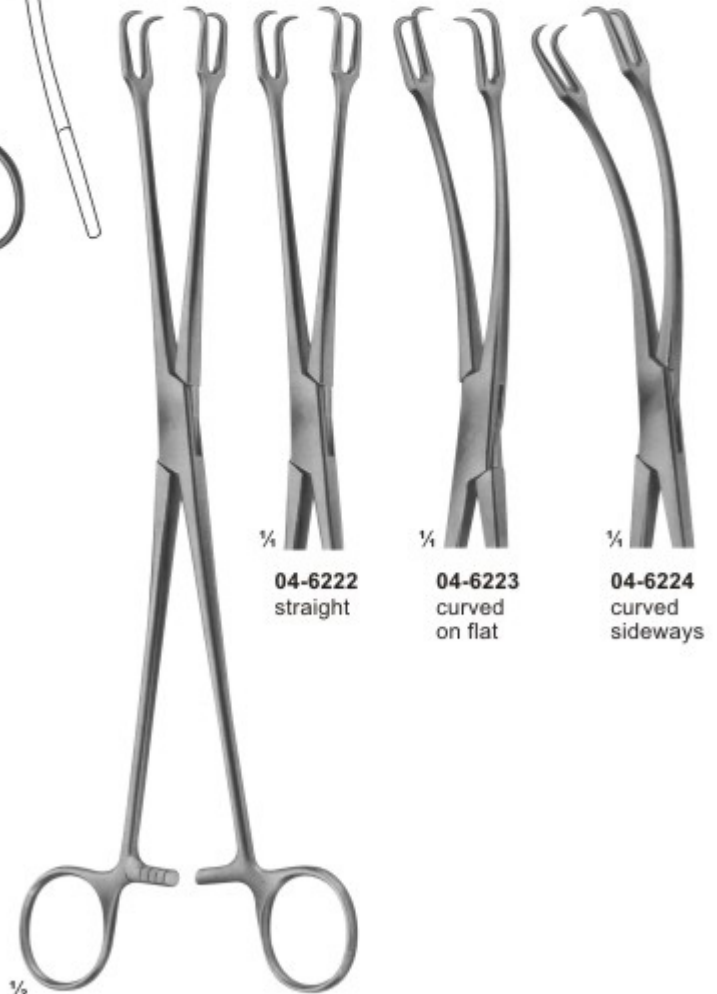

04-6222
straight

04-6223
curved
on flat

04-6224
curved
sideways

04-6222 - 04-6224
SCHROEDER
250 mm

Uterine Tenaculum Forceps

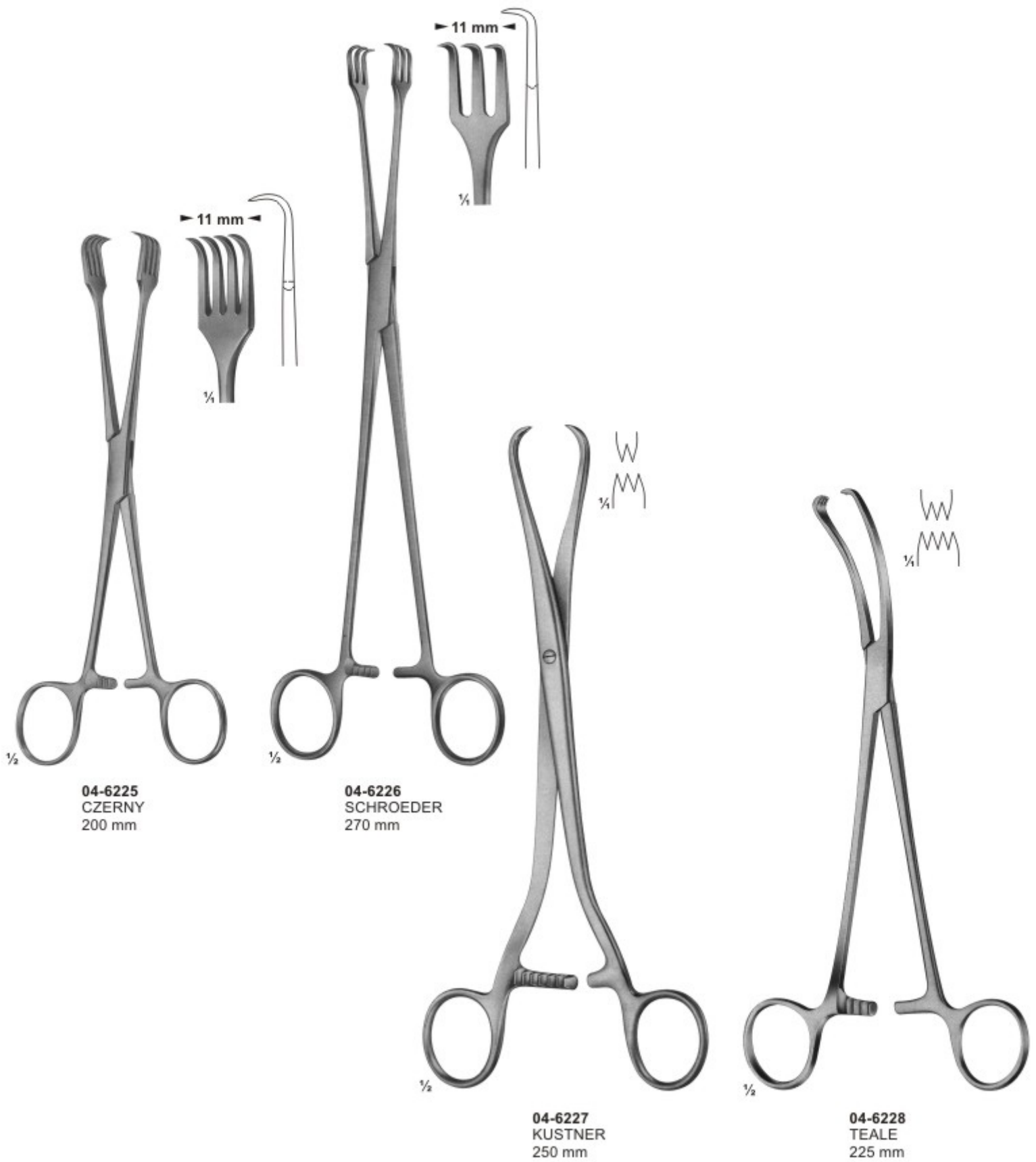

Uterine Tenaculum Forceps

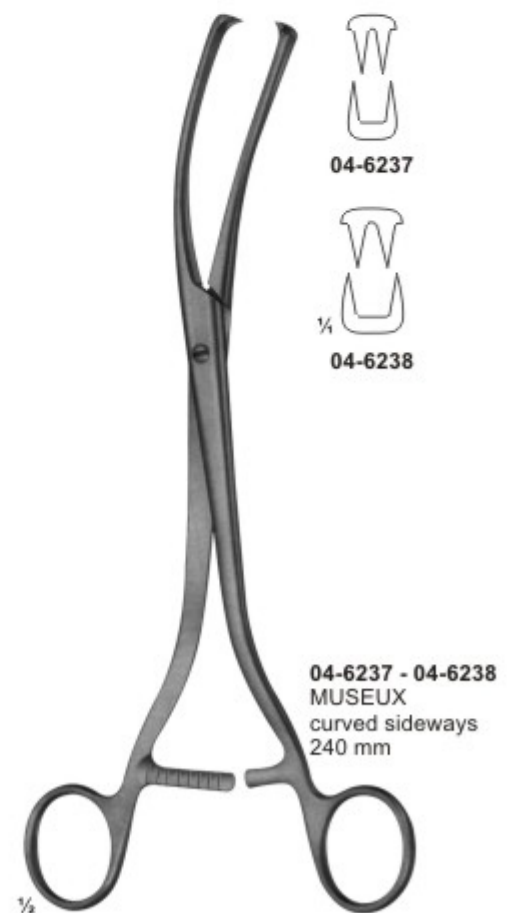
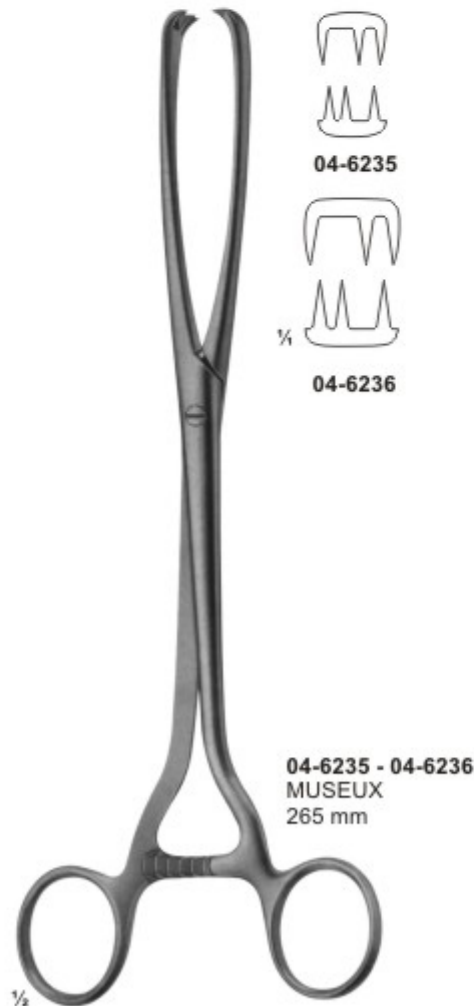
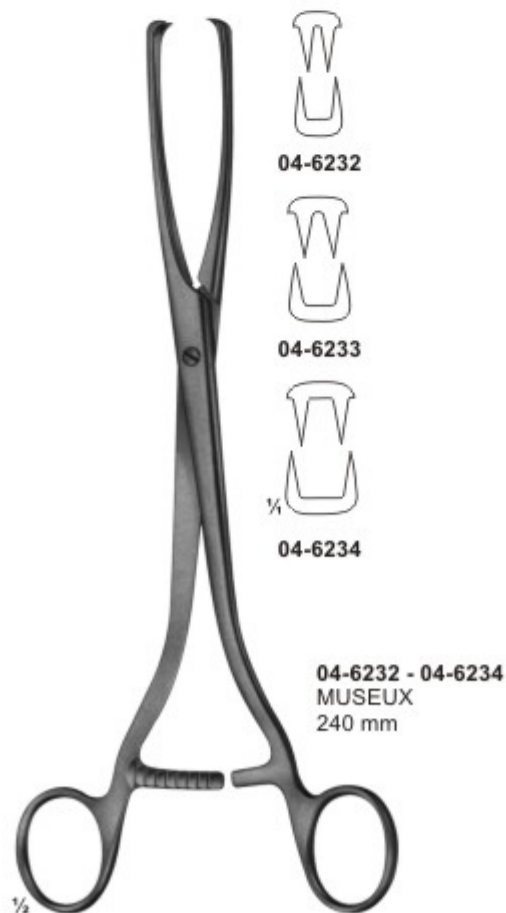

Polypus-and Ovum Forceps

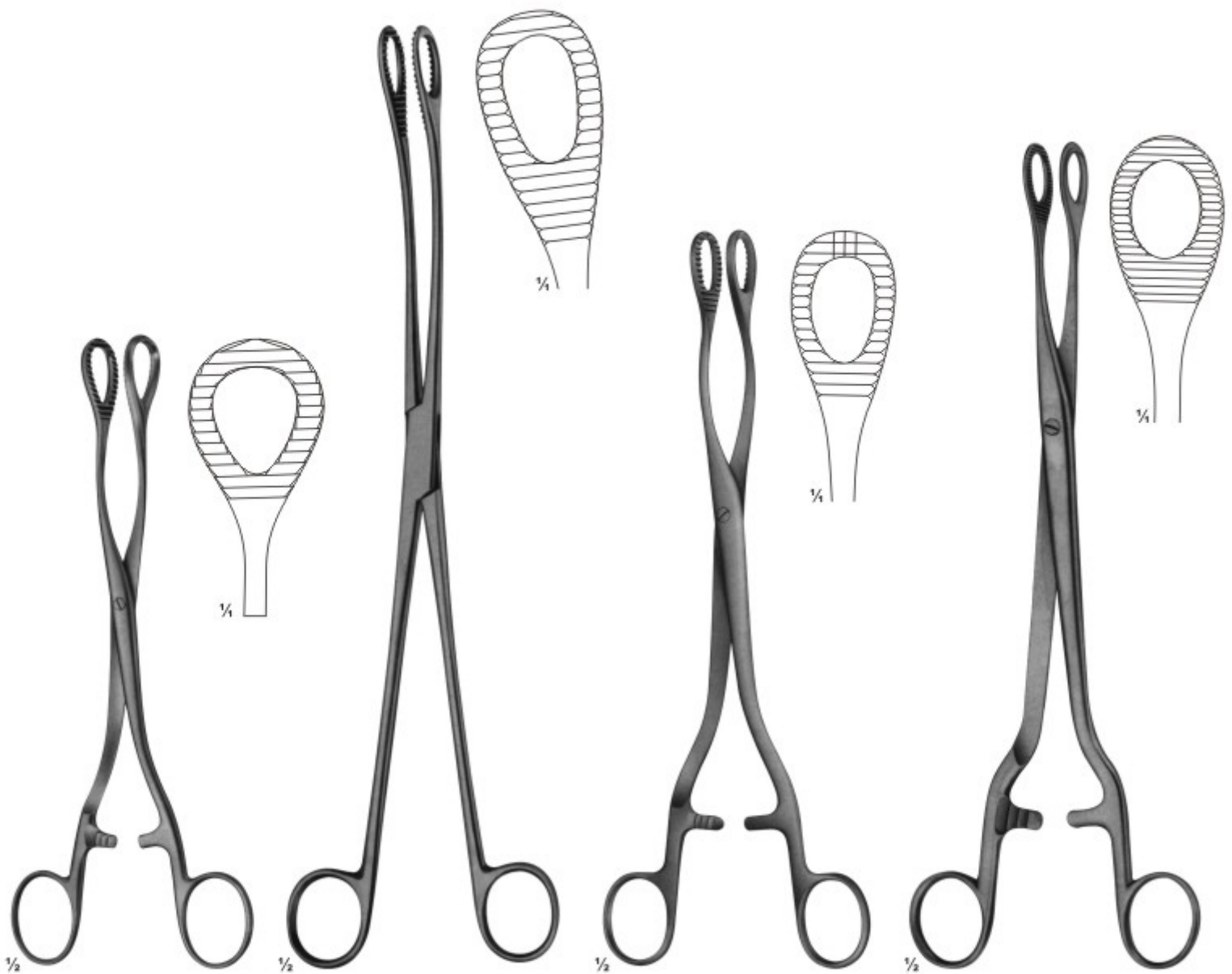

04-6239
HEYWOOD-SMITH
200 mm

04-6240
KELLY
320 mm

04-6241
HEYWOOD-SMITH
250 mm

04-6242
NOTO
280 mm

Polypus and Ovum Forceps

Atraumata



04-6244
250mm

04-6245
270mm



04-6243
DOYEN
185 mm



04-6244 - 04-6245



04-6246
BUMM
280 mm

Uterine Elevating Forceps



04-6247
COLLIN
250 mm



04-6248
COLLIN
285 mm



04-6249
DARTIGUES
255 mm

Uterine Elevating Forceps



04-6250
SOMER
235 mm



04-6251
STRASSMANN
265 mm

Uterine Elevating Forceps

With movable jaws



04-6252
COLLIN
265 mm

With movable jaws



04-6253
APPREX
approx. 260 mm

Myoma Instruments, Instruments For Micro Tubal Operations



04-6254
SEGOND
Myomatome
270 mm



04-6255
DOYEN
Myoma screw
150 mm



04-6256
DOYEN
Myoma screw
190 mm



04-6257 **04-6258** **04-6259**
∅ 6mm ∅ 8mm ∅ 10mm

04-6257 - 04-6259
NEUBUSER
Tubal seizing forceps
200 mm



04-6260
Splint guide
with thread



04-6261
Splint guide
with round
handle
180 mm



04-6262
Angled glass rods
Set . 3 pieces

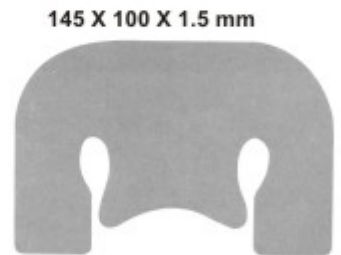

145 X 100 X 1.5 mm

04-6263
Silicon operating pad
pre-cut



04-6264
Polyaethylen splint material
soft-sterile
0.45 mm

Biopsy Curettes

Malleable

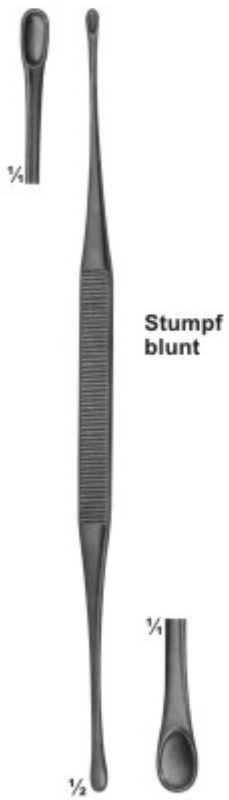

04-6265
ASCH
Uterine
Secretion scoop
200 mm

Malleable

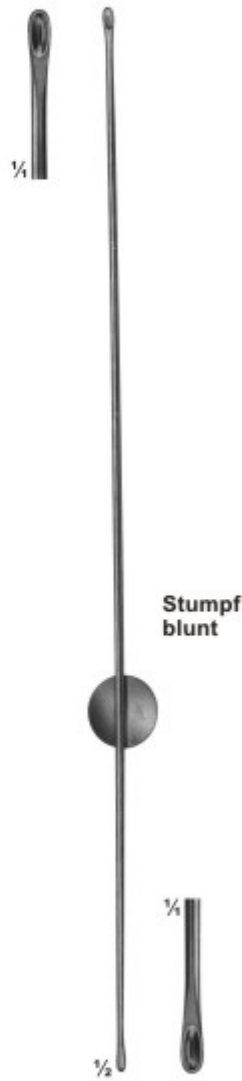

04-6266
Uterine
Secretion scoop
270 mm



04-6267
NOVAK-SCHOECKAERT
Endometrial biopsy
curette
240 mm



04-6268
RANDALL
Endometrial
biopsy curette
240 mm

Biopsy Forceps

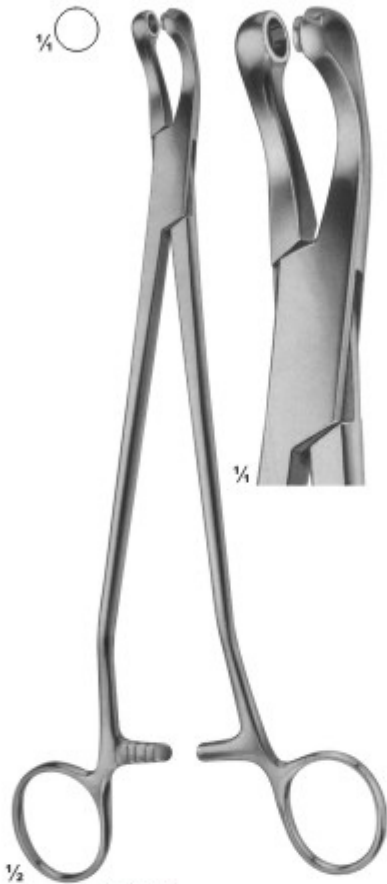

04-6269
THOMS-GAYLOR
240 mm



04-6270
SCHUBERT
260 mm

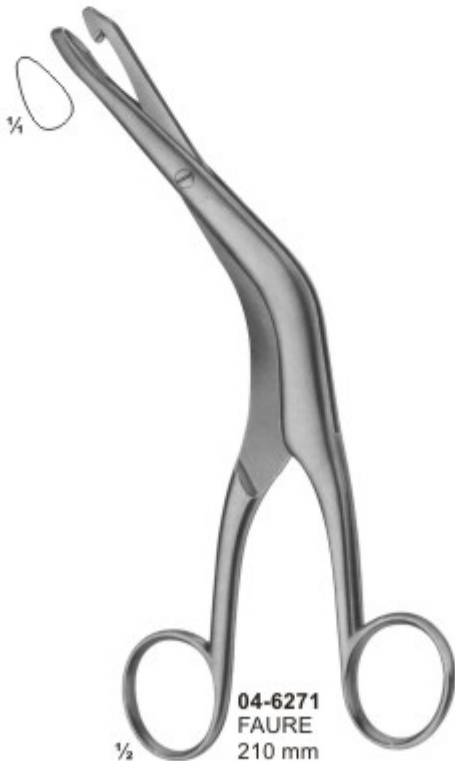

04-6271
FAURE
210 mm

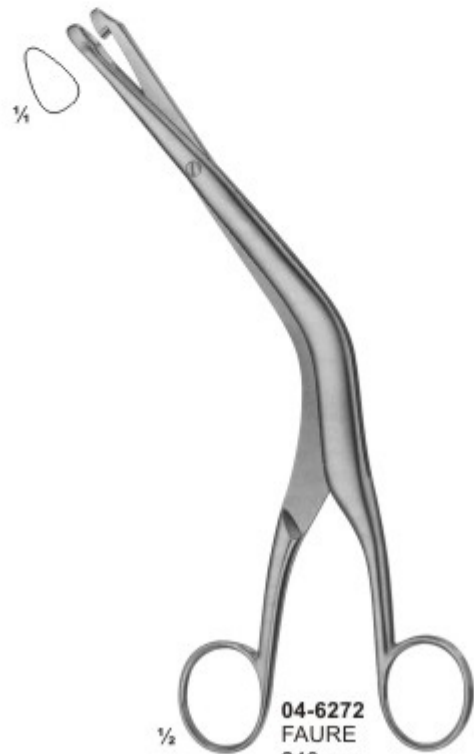

04-6272
FAURE
240 mm

Biopsy Forceps

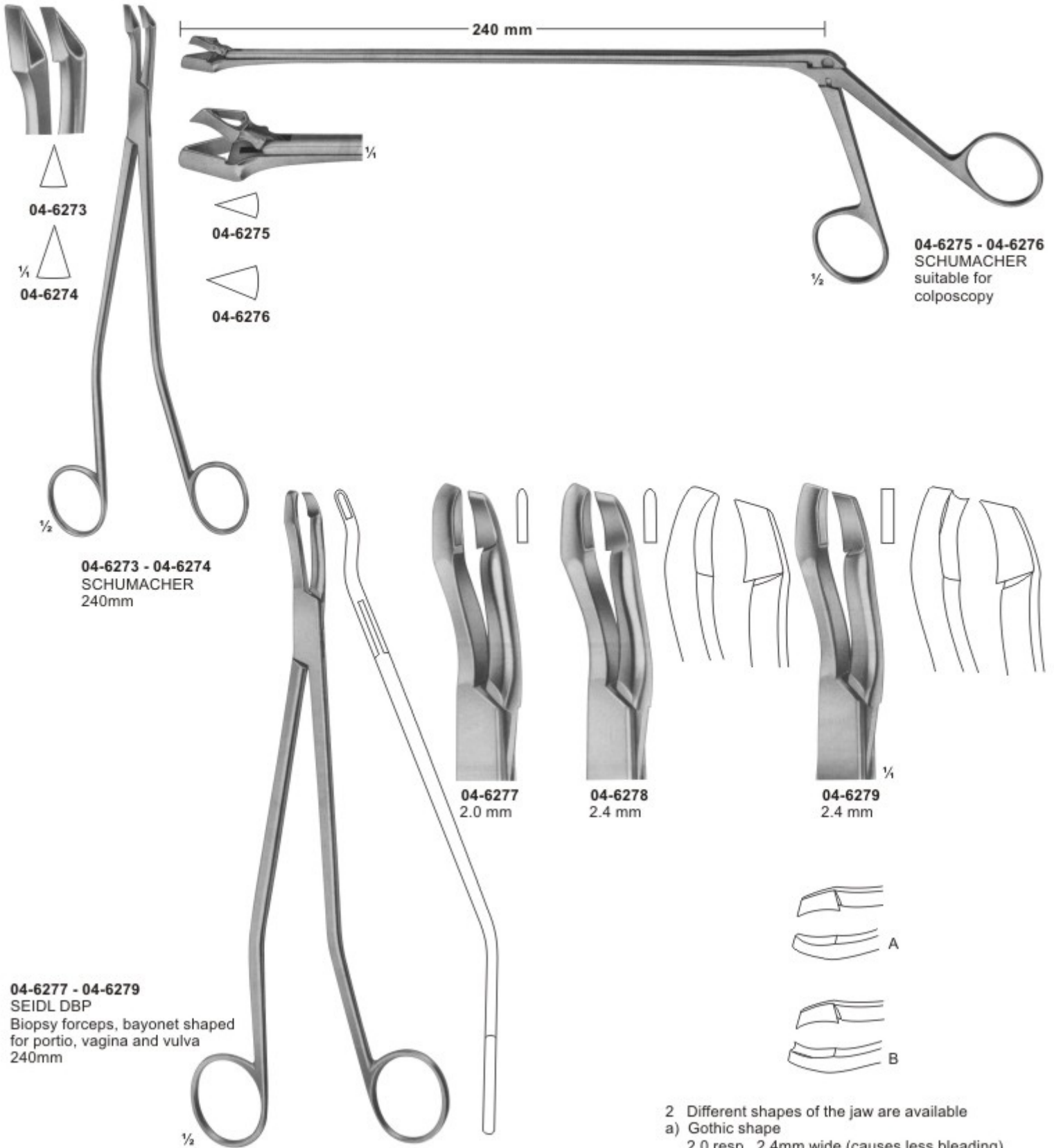

2 Different shapes of the jaw are available
 a) Gothic shape
 2.0 resp 2.4mm wide (causes less bleeding)
 b) Rectangular shape, 2.4mm wide

Biopsy Forceps

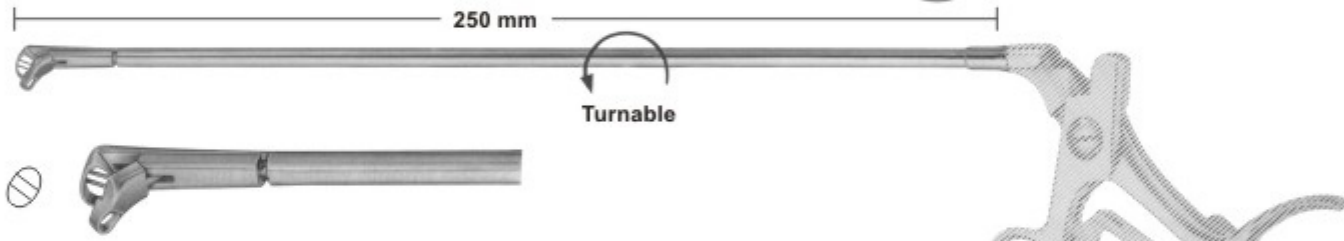
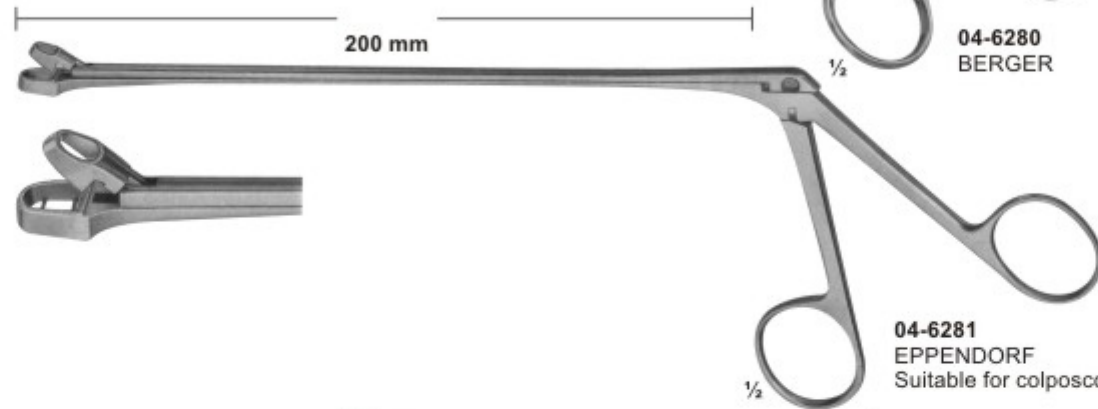
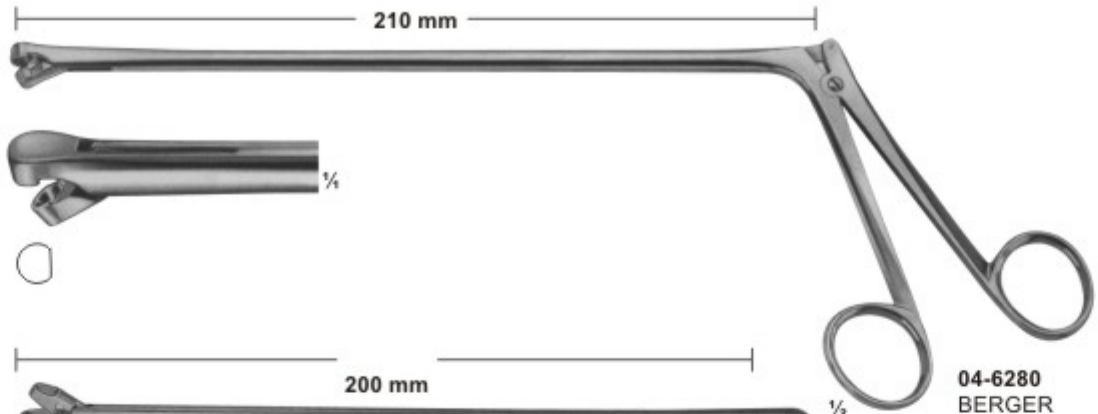

with drawing cut, beginning from the top
universal handle

04-6283 attachment only

04-6282 for handle



Extension cannulae

04-6285 BRUENINGS 200 mm Length
04-6286 BRUENINGS 250 mm Length

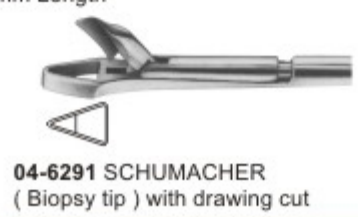

Uterine Scoops

Table of Recamier		Sharp		Blunt
Fig	Width	Rigid	Malleable	Rigid
00	4.5mm	04-6294		
0	7.5mm	04-6295		04-6306
1	8.5mm	04-6296	04-6317	04-6307
2	10.5mm	04-6297	04-6318	04-6308
3	12.0mm	04-6298	04-6319	04-6309
4	14.0mm	04-6299	04-6320	04-6310
5	15.0mm	04-6300	04-6321	04-6311
6	16.5mm	04-6301	04-6322	04-6312
7	18.0mm	04-6302	04-6323	04-6313
8	19.5mm	04-6303	04-6324	04-6314
9	21.5mm	04-6304		04-6315
10	23.5mm	04-6305		04-6316
04-6294- 04-6305		Sharp - Rigid		
04-6317- 04-6324		Sharp - Malleable		
04-6306- 04-6316		Blunt - Rigid		

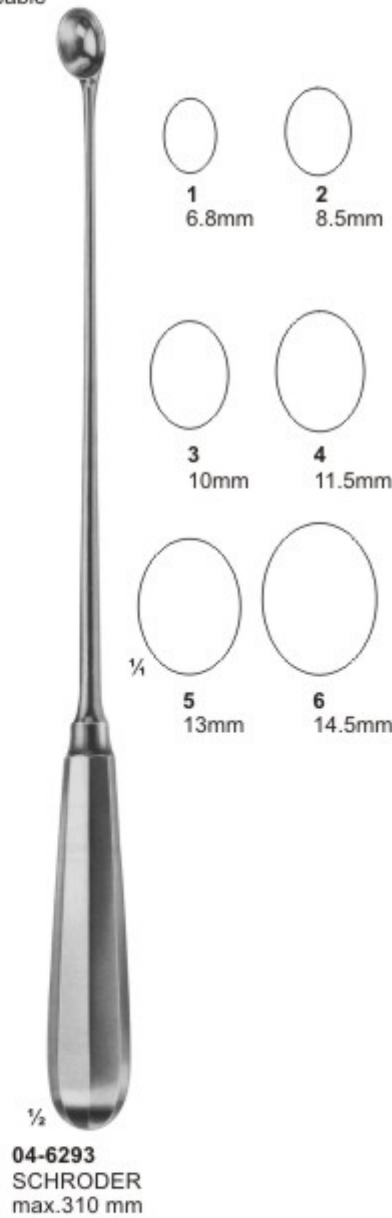
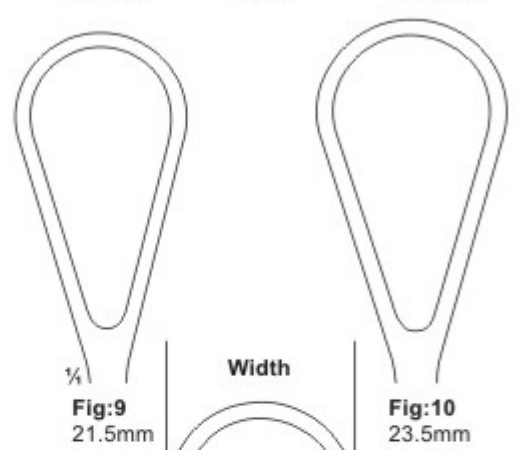
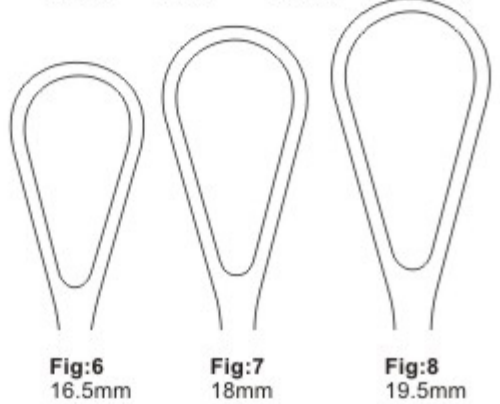
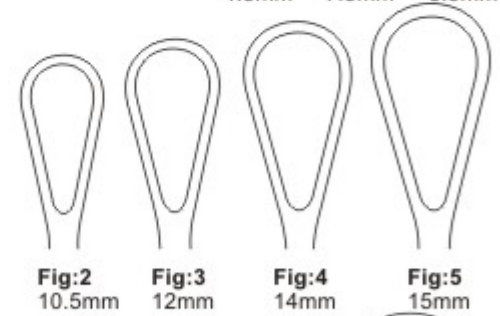
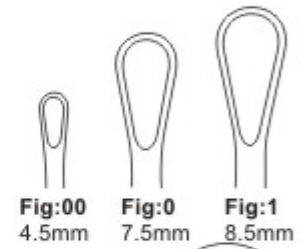

Uterine Curettes

Fig	Width	Sharp		Blunt	
		Rigid	Malleable	Rigid	
1	7.5mm	04-6325	04-6331	04-6337	
2	8.5mm	04-6326	04-6332	04-6338	
3	10.5mm	04-6327	04-6333	04-6339	
4	12.0mm	04-6328	04-6334	04-6340	
5	14.0mm	04-6329	04-6335	04-6341	
6	15.0mm	04-6330	04-6336	04-6342	
04-6325 - 04-6330		Sharp - Rigid			
04-6331 - 04-6336		Sharp - Malleable			
04-6337 - 04-6342		Blunt - Rigid			

Fig	Width	Blunt - Malleable
0	16.5mm	04-6343
1	18.5mm	04-6344
2	19.5mm	04-6345
3	21.5mm	04-6346
4	23.5mm	04-6347
5	26.0mm	04-6348
6	28.5mm	04-6349

BUMM

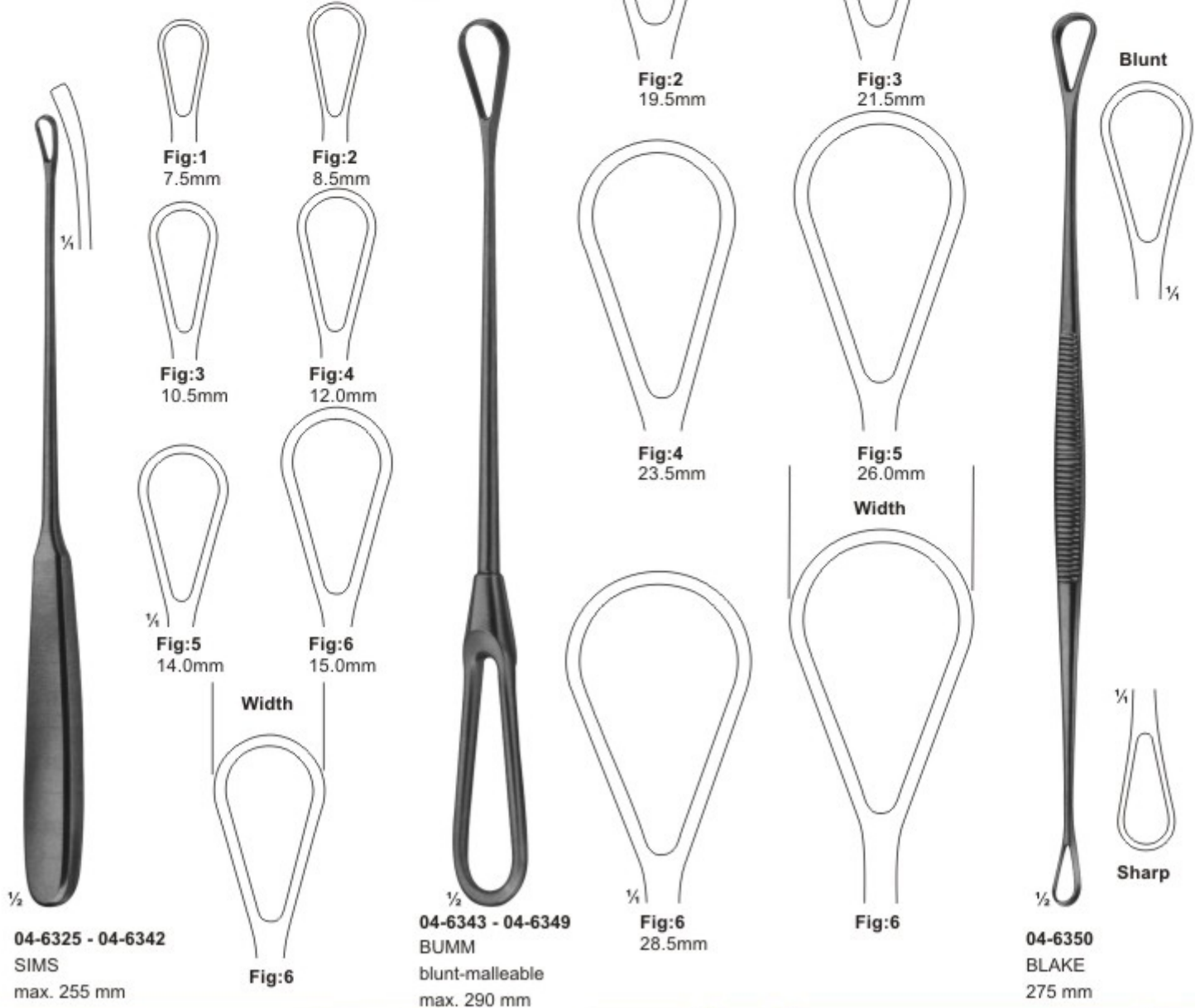

Fig:0 16.0mm

Fig:1 18.0mm

Fig:2 19.5mm

Fig:3 21.5mm

Fig:4 23.5mm

Fig:5 26.0mm

Fig:6 28.5mm

Fig:1 7.5mm

Fig:2 8.5mm

Fig:3 10.5mm

Fig:4 12.0mm

Fig:5 14.0mm

Fig:6 15.0mm

Width

Blunt

Sharp

04-6325 - 04-6342
SIMS
max. 255 mm

04-6343 - 04-6349
BUMM
blunt-malleable
max. 290 mm

04-6350
BLAKE
275 mm

Placenta-and Ovum Curettes

Fig	Width	Sharp Malleable	Blunt Malleable
1	23.5mm	04-6354	04-6356
2	26.0mm		04-6357
3	28.5mm	04-6355	04-6358



04-6351
COLLIN
300 mm



04-6352 - 04-6353
RECAMIER
blunt-rigid
max. 360 mm

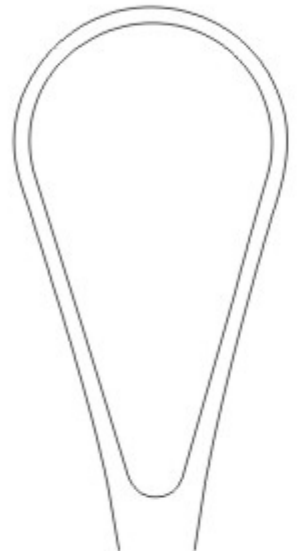

Fig:1

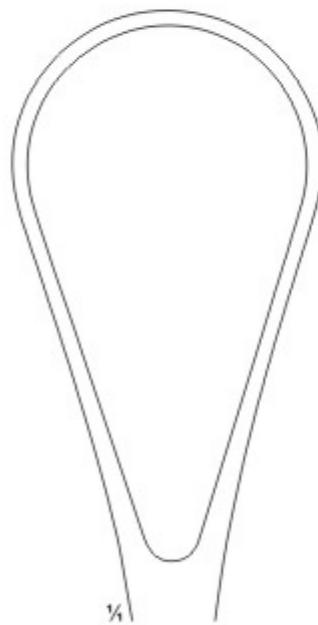

Fig:2



Fig:1

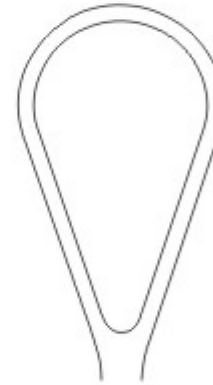

Fig:2

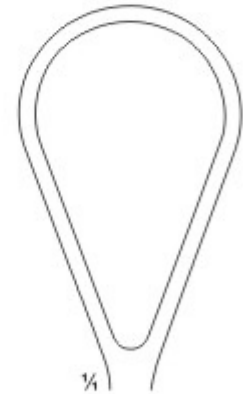

Fig:3



04-6354 - 04-6358
BUMME
max. 310 mm
04-6354 - 04-6355 sharp-malleable
04-6356 - 04-6358 blunt-malleable

Vacuum Currettes

04-6359 - 04-6364

Suction currettes, stainless steel, fitting hose connection.

Working tips are smoothly rounded off, therefore no danger of perforation.

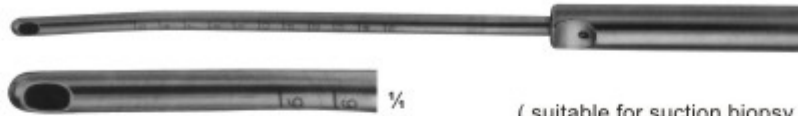

(suitable for suction biopsy)

04-6359: diam 4 mm

04-6360: diam 6 mm

04-6361: diam 8 mm

04-6362: diam 10 mm

04-6363: diam 12 mm

04-6364: diam 14 mm

04-6365

Hose connection inside diam. 11 mm, curved, stainless steel.



The new connection between suction curette and hose connection, (**04-6365**) Guarantees quick changing and free turning of the suction currettes on the hose connection.

04-6366

Transparent suction hose 1.8 m long, inside diam 11 mm, outside diam 16.5 mm can be sterilized in an autoclave at 1 bar overpressure (120 °C)

04-6367

Strainer for tissues, plastic, for single use only, to be used for histopathological examination.



Gynaecological Instruments



04-6368 diam 8 mm
 04-6369 diam 10 mm
 BOZEMANN-FRITSCH
 Uterine Flushing Tube
 350 mm

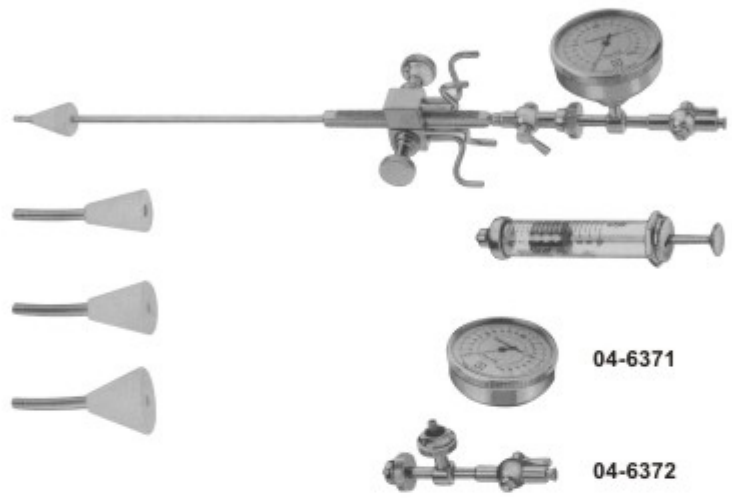

04-6370
 SCHULZE
 Salpingograph, for utero-salpingography
 in wooden case, consisting of:
 04-6371 Manometer only
 04-6372 Connection only, without manometer
 04-6373 Uterine cannula with tape without cone
 04-6374 Cone only, small
 04-6375 Cone only, medium
 04-6376 Cone only, large
 04-6377 Record syringe, 10CC, luer-lock mount.

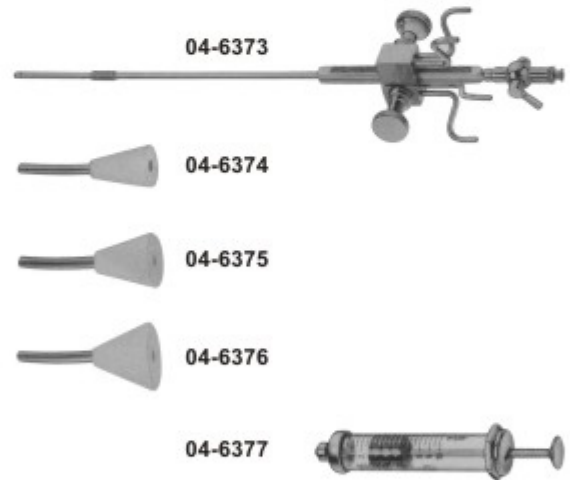

04-6378
 SCHULZE
 Salpingograph, equipment like(04-6370)
 but without manometer.

Obstetrics-Pelvimeters



04-6379
THOLE
for internal and external measurements, graduated in centimeters



04-6380
DE LEE
graduated in centimeters and inches



04-6381
COLLIN
graduated in centimeters



04-6382
MARTIN
graduated in centimeters



for internal measurements between symphysis and promontory

04-6383
SCHNEIDER
graduated in centimeters

The additional straight arm can be replaced. The pelvimeter with straight arm is used for localisation of the portio vaginalis uteri and of vaginal metastasis.



04-6384
BREISKY
graduated in centimeters

Forceps For Obstetrics

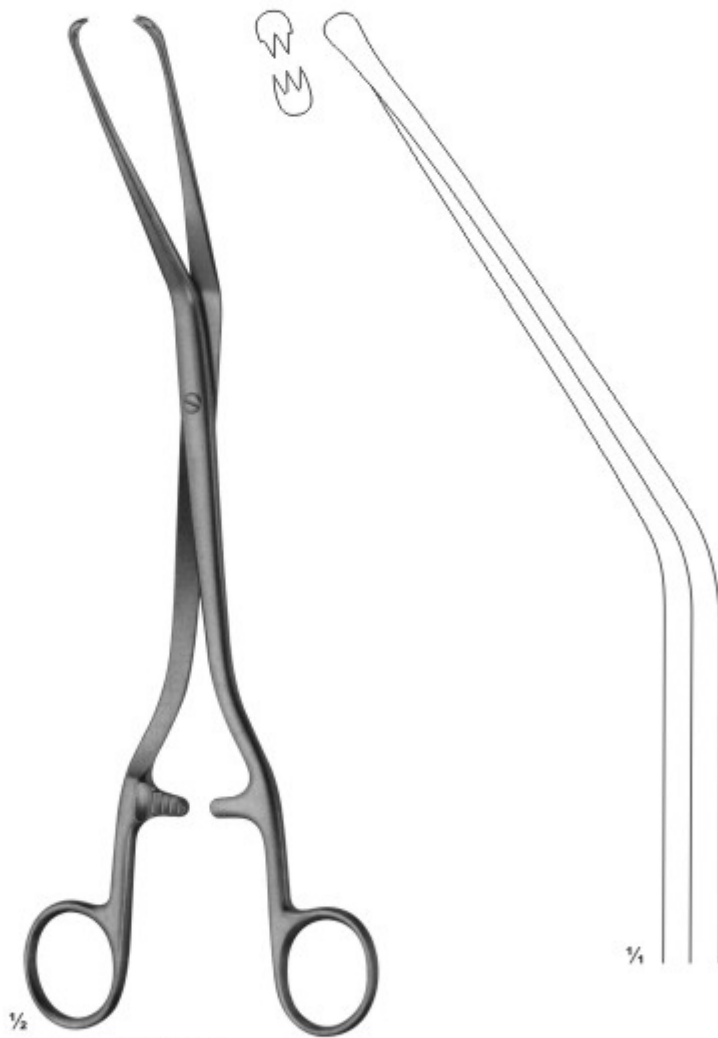

04-6385
HERFF
membrane puncturing
forceps
255 mm



04-6386
IOWA
membrane puncturing
forceps
260 mm

Scissors of Obstetrics, Umbilical cord clamp



04-6387
SCHUMACHER
Umbilical cord
scissors
155 mm



04-6388
Umbilical cord
scissors
105 mm

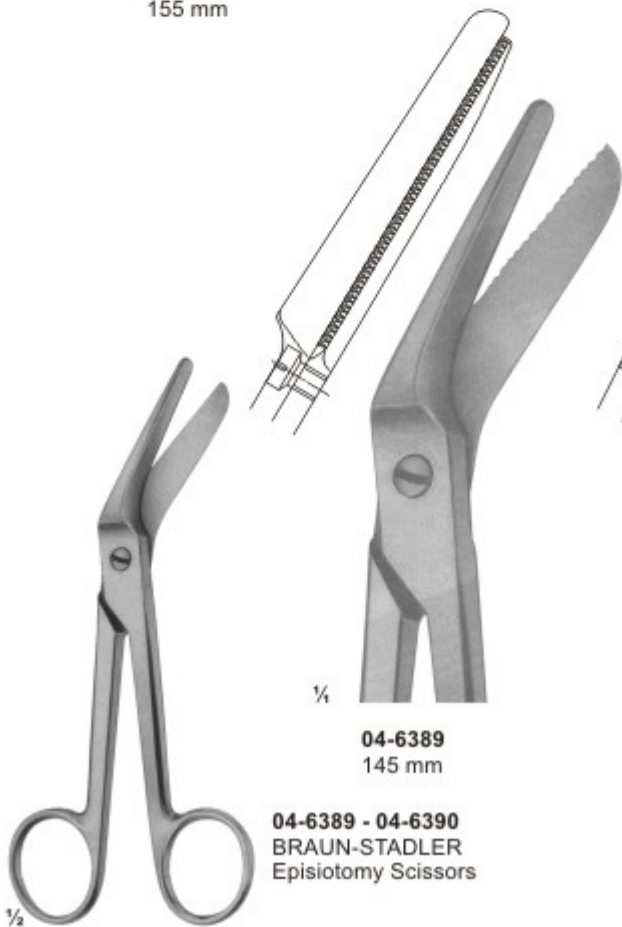

04-6389
145 mm

04-6389 - 04-6390
BRAUN-STADLER
Episiotomy Scissors

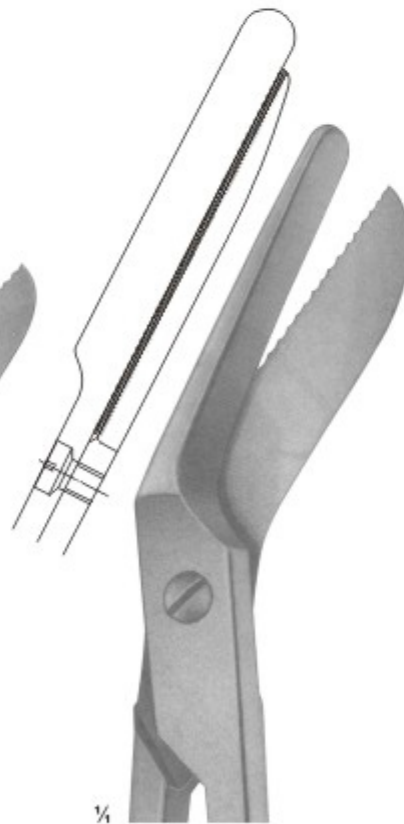

04-6390
200 mm

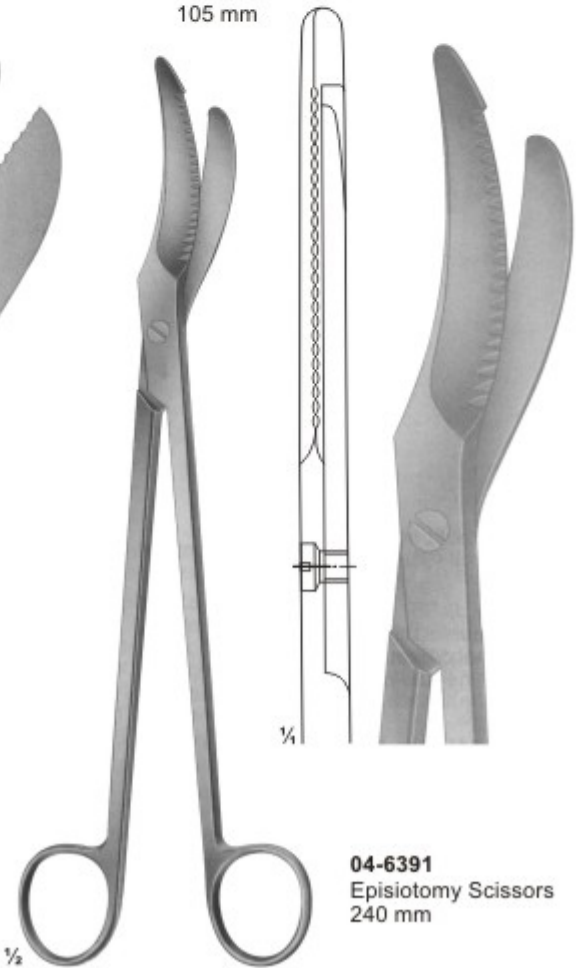

04-6391
Episiotomy Scissors
240 mm

Obstetrics - Obstetrical Forceps



04-6392
NAEGELE
355 mm



04-6393
NAEGELE
400 mm



04-6394
SIMPSON-BRAUN
305mm

Obstetrics - Obstetrical Forceps



1/3

04-6395
SIMPSON-BRAUN
350mm

For caesarean section



1/3

04-6396
SIMPSON
235mm

For caesarean section



1/3

04-6397
WRIGLEY
250 mm

Obstetrics Forceps



04-6398
GREEN-ARMYTAGE
Caesarean section haemostatic
forceps, for edges of the transverse
incision in the lower segment
220 mm



04-6399
WILLETT
Scalp Flap forceps
185 mm

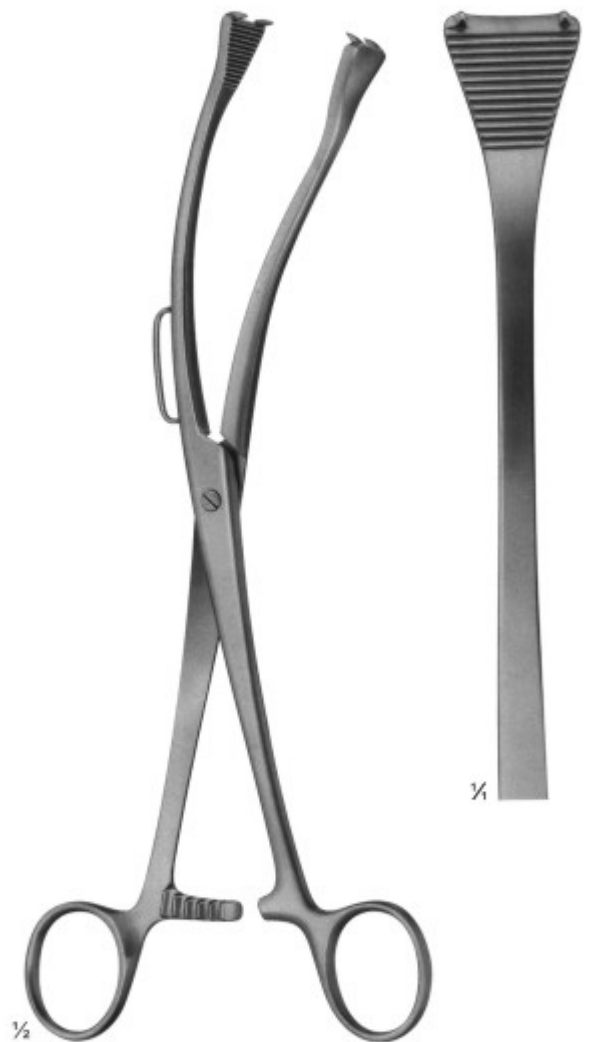

04-6400
GAUSS
Scalp Flap forceps
260 mm

Obstetrics-Placenta and Ovum Forceps

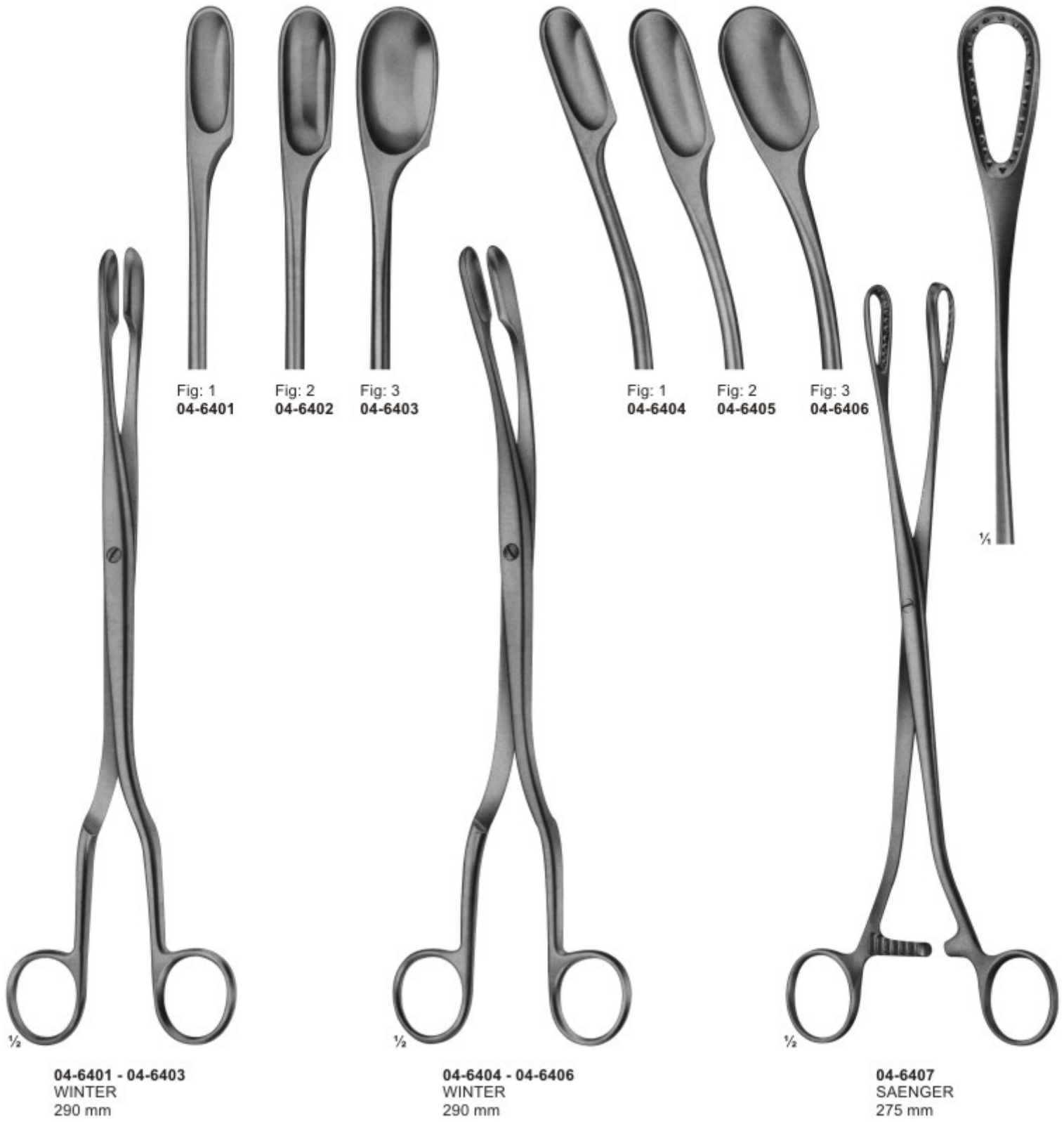

Fig: 1
04-6401

Fig: 2
04-6402

Fig: 3
04-6403

Fig: 1
04-6404

Fig: 2
04-6405

Fig: 3
04-6406

¼

½

04-6401 - 04-6403
WINTER
290 mm

½

04-6404 - 04-6406
WINTER
290 mm

½

04-6407
SAENGER
275 mm

Obstetrics-Placenta and Ovum Forceps

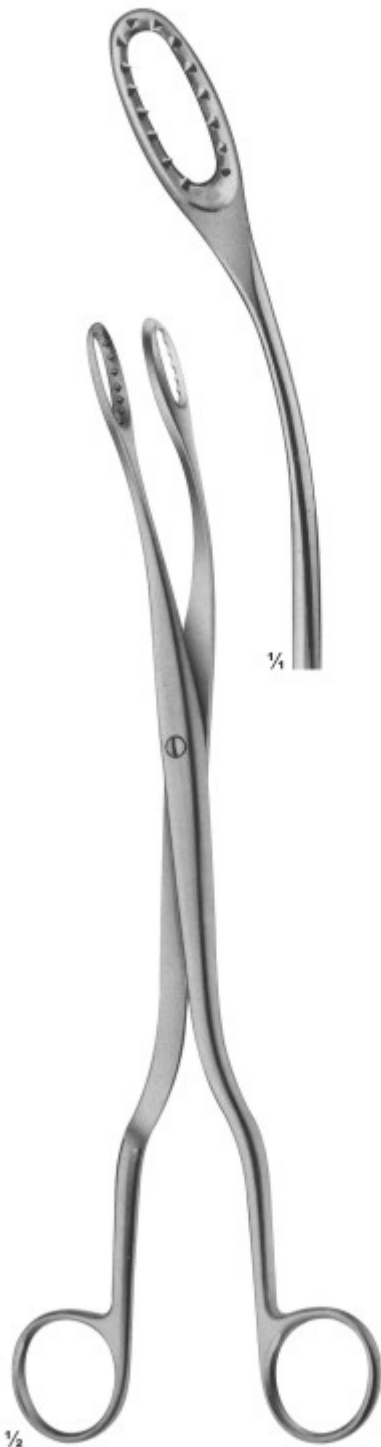

04-6408
SAENGER
285 mm

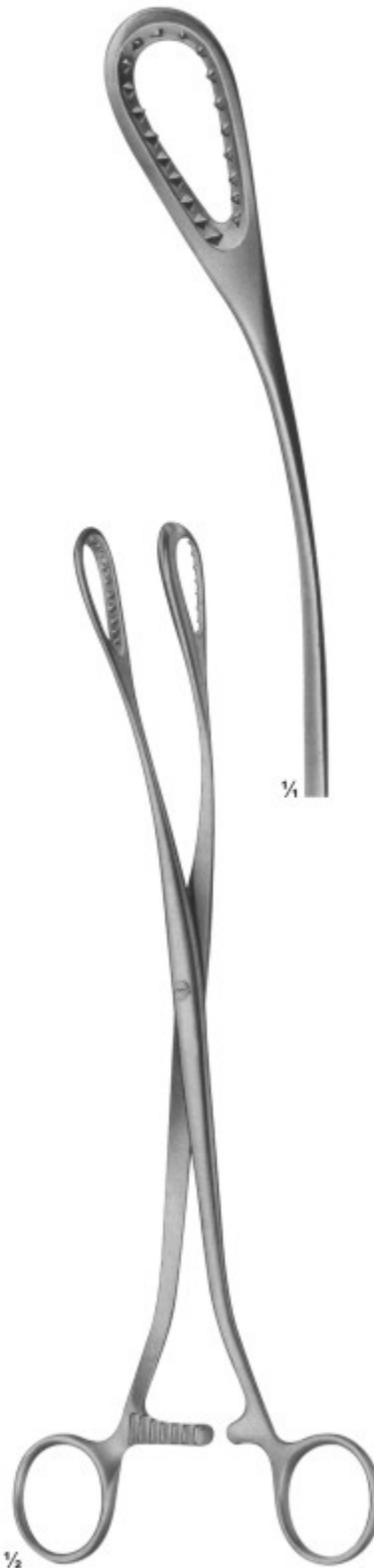

04-6409
SAENGER
265 mm



$\frac{1}{4}$
04-6410

04-6411

$\frac{1}{2}$
04-6410 - 04-6411
LEWKOWITZ
245 mm

Obstetrics-Placenta and Ovum Forceps, Perforator, Cranioclast

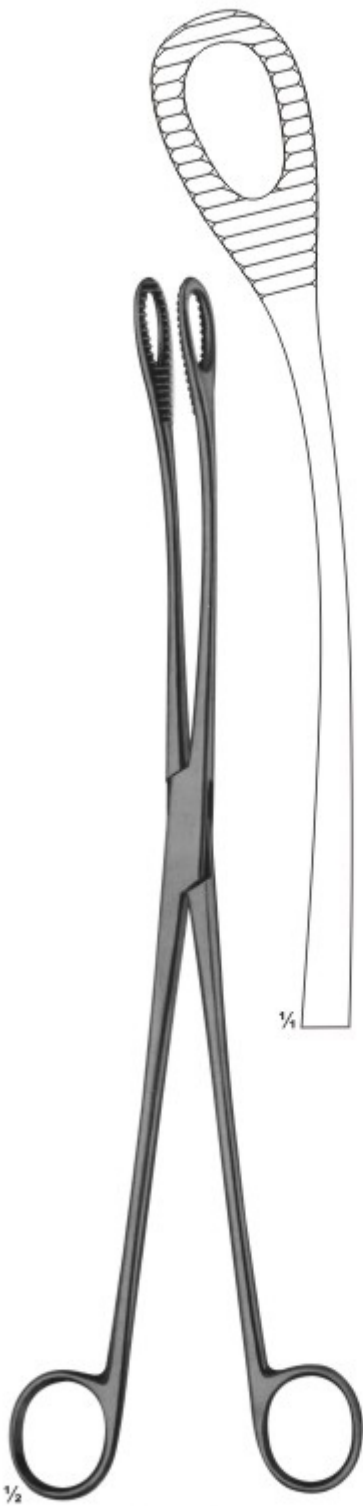

04-6412
KELLY
320mm



04-6413
SMELLIE
Perforator
270mm

1 jaws fenestrated



04-6414
BRAUN
Cranioclast
420mm

Tracheal Tubes with inner tubes

Fig.	0	1	2	3	4	5	6	7	8	9	10
\varnothing mm	4	5	6	7	8	9	10	11	12	13	14
Charr./Fr.	12	15	18	21	24	27	30	33	36	39	42



1/2

05-7001
UECKERMANN-DENKER
Cryothyrotomy trocar
with silver cannula
130mm

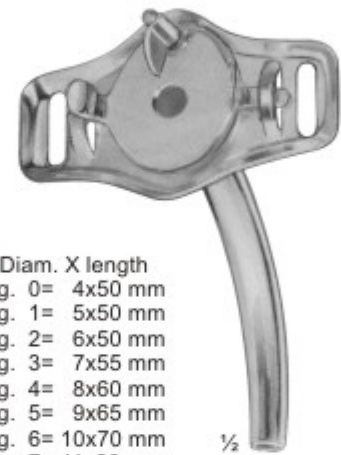

1/2

Diam. X length
05-7002 Fig. 0= 4x50 mm
05-7003 Fig. 1= 5x50 mm
05-7004 Fig. 2= 6x50 mm
05-7005 Fig. 3= 7x55 mm
05-7006 Fig. 4= 8x60 mm
05-7007 Fig. 5= 9x65 mm
05-7008 Fig. 6= 10x70 mm
05-7009 Fig. 7= 11x80 mm
05-7010 Fig. 8= 12x85 mm
05-7011 Fig. 9= 13x90 mm
05-7012 Fig. 10=14x90 mm

05-7002 - 05-7012
LUER
German silver



1/2

05-7013 - 05-7022
JACKSON
German Silver

Diam. X length
05-7013 Fig. 0= 4x50 mm
05-7014 Fig. 1= 5x48 mm
05-7015 Fig. 2= 6x58 mm
05-7016 Fig. 3= 7x70 mm
05-7017 Fig. 4= 8x78 mm
05-7018 Fig. 5= 9x84 mm
05-7019 Fig. 6= 10x84 mm
05-7020 Fig. 7= 11x86 mm
05-7021 Fig. 8= 12x88 mm
05-7022 Fig. 9= 13x90 mm



1/2

Diam. X length
05-7023 Fig. 1= 5x48 mm
05-7024 Fig. 2= 6x58 mm
05-7025 Fig. 3= 7x70 mm
05-7026 Fig. 4= 8x78 mm
05-7027 Fig. 5= 9x84 mm
05-7028 Fig. 6= 10x84 mm
05-7029 Fig. 7= 11x86 mm
05-7030 Fig. 8= 12x88 mm
05-7031 Fig. 9= 13x90 mm
05-7032 Fig. 10= 14x90 mm

05-7023 - 05-7032
JACKSON
Stainless Steel

Wound-and Tracheal Hooks and Dilators



05-7033
BOSE
165 mm



05-7034
BOSE
165 mm



05-7035 - 05-7037
180 mm



05-7035
sharp



05-7036
blunt



05-7037
blunt



05-7038
FINSEN
50 mm



05-7039
FINSEN
70 mm



05-7040
TROUSSEAU
120 mm



05-7041
LABORDE
125 mm



05-7042
LABORDE
strong pattern
135 mm



05-7043
Cleaning Brush
for tracheal tubes
285 mm

Irrigating Cannulae, Embolus Grasping Forceps, Dilators



05-7044 - 05-7047
SCHMID
 Vessel irrigating cannulae,
 malleable, silver plated
 150 mm



05-7048
BLAKE
 Embolus grasping
 forceps
 205 mm

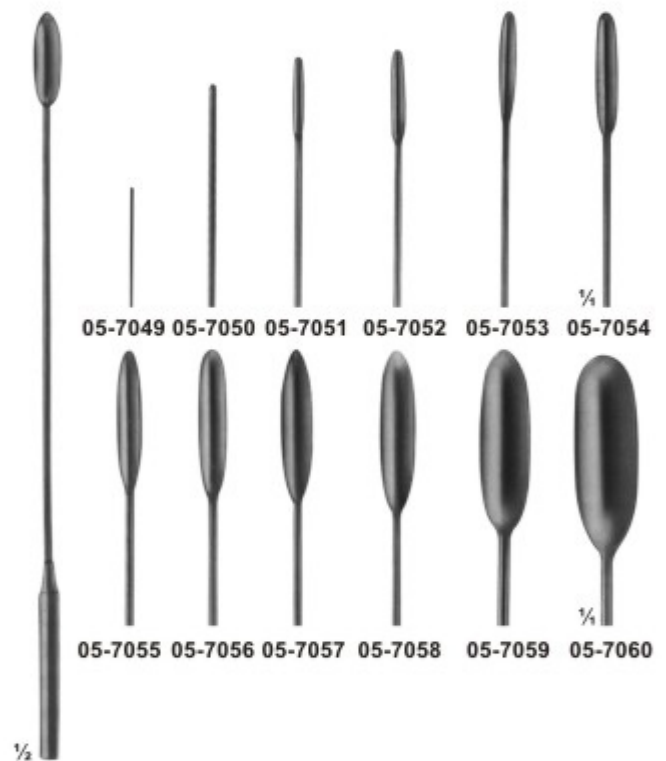

05-7049 - 05-7060
DE BAKEY
 Vascular dilators,
 malleable
 190 mm

05-7049 0,5 mm Ø	05-7055 3,5 mm Ø
05-7050 1,0 mm Ø	05-7056 4,0 mm Ø
05-7051 1,5 mm Ø	05-7057 4,5 mm Ø
05-7052 2,0 mm Ø	05-7058 5,0 mm Ø
05-7053 2,5 mm Ø	05-7059 7,0 mm Ø
05-7054 3,0 mm Ø	05-7060 9,0 mm Ø

Vascular Spatulas

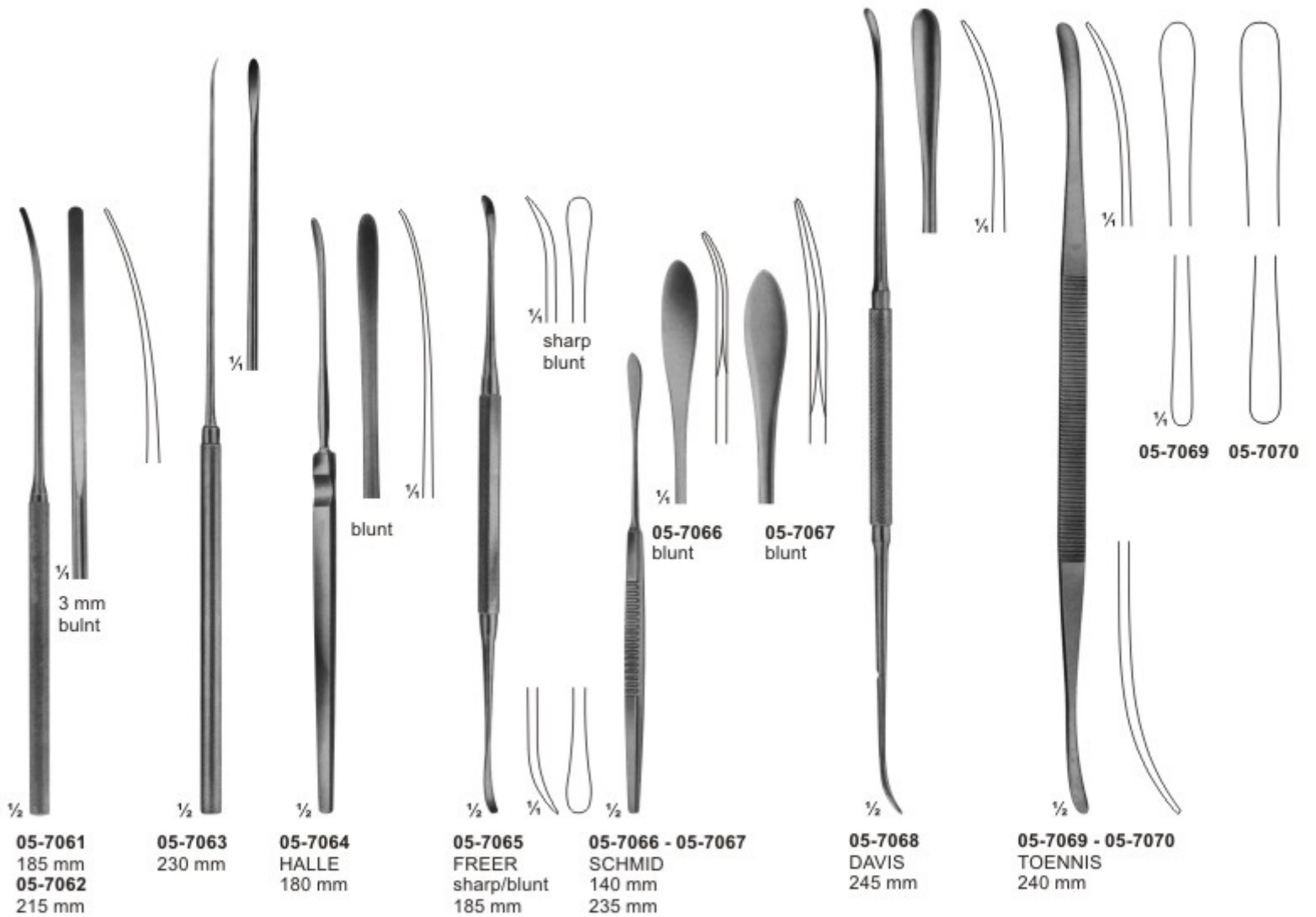

Endarterectomy Strippers, Tourniquets

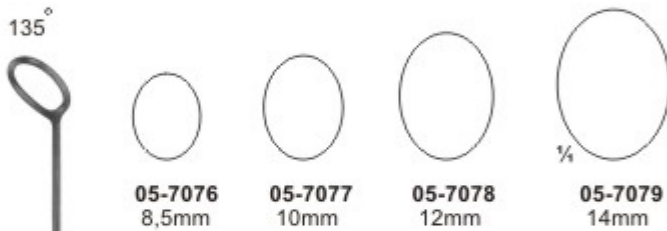
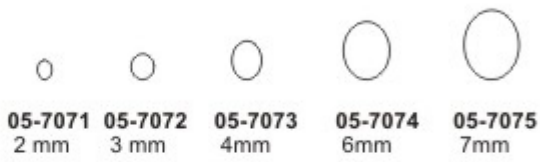

Bioptome and Aortic Dilators

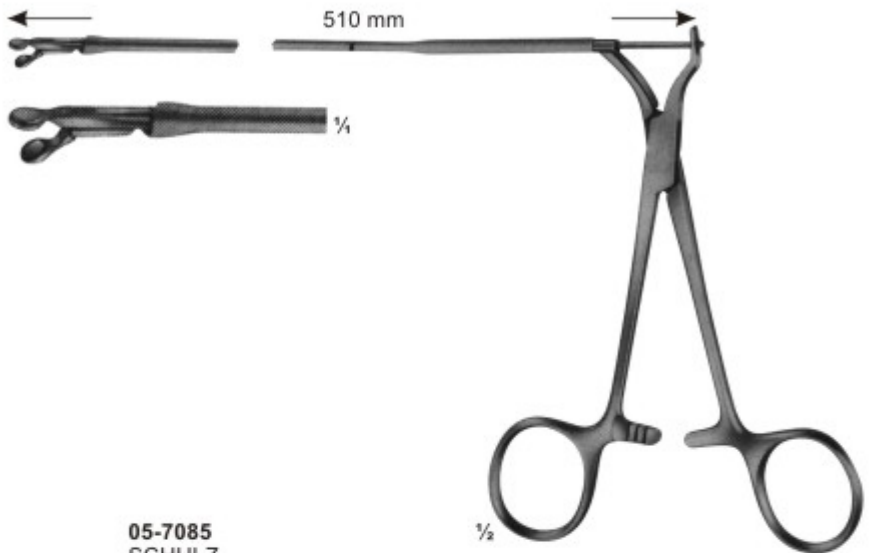

**05-7085
SCHULZ**
Bioptome, with flexible Shaft, 510 mm long,
with round jaws 3 mm diam.

Biopsy forceps, for biopsy from the right atrium
through cava jugularis, prior to heart implantations.

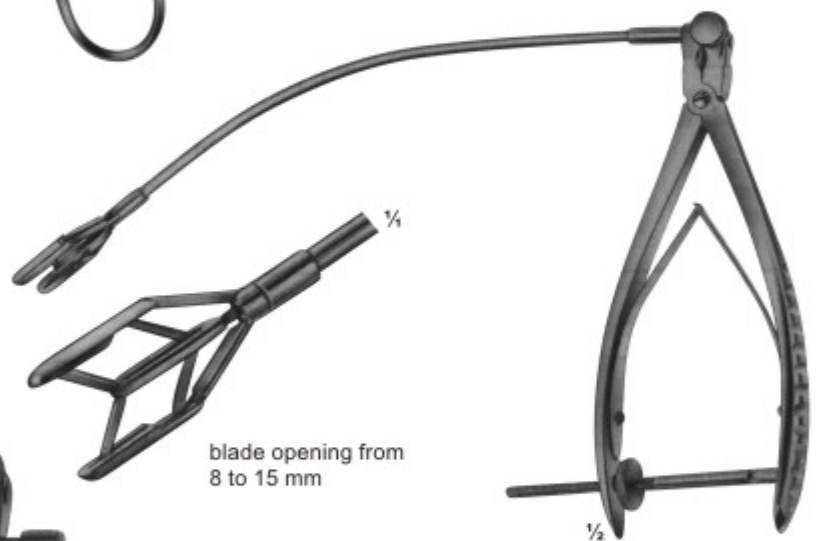

**05-7087
COOLEY**
Dilator for
mitral valve
for children

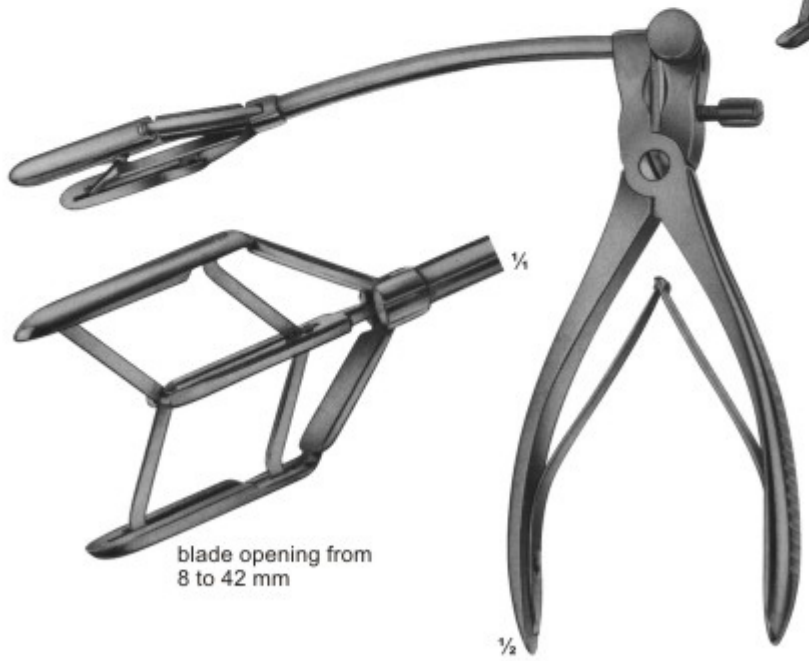

**05-7086
TUBBS**
Dilator for
mitral valve

JENKER Instrument Set For Tunnelling And Pulling-Through Vascular Grafts Toothings

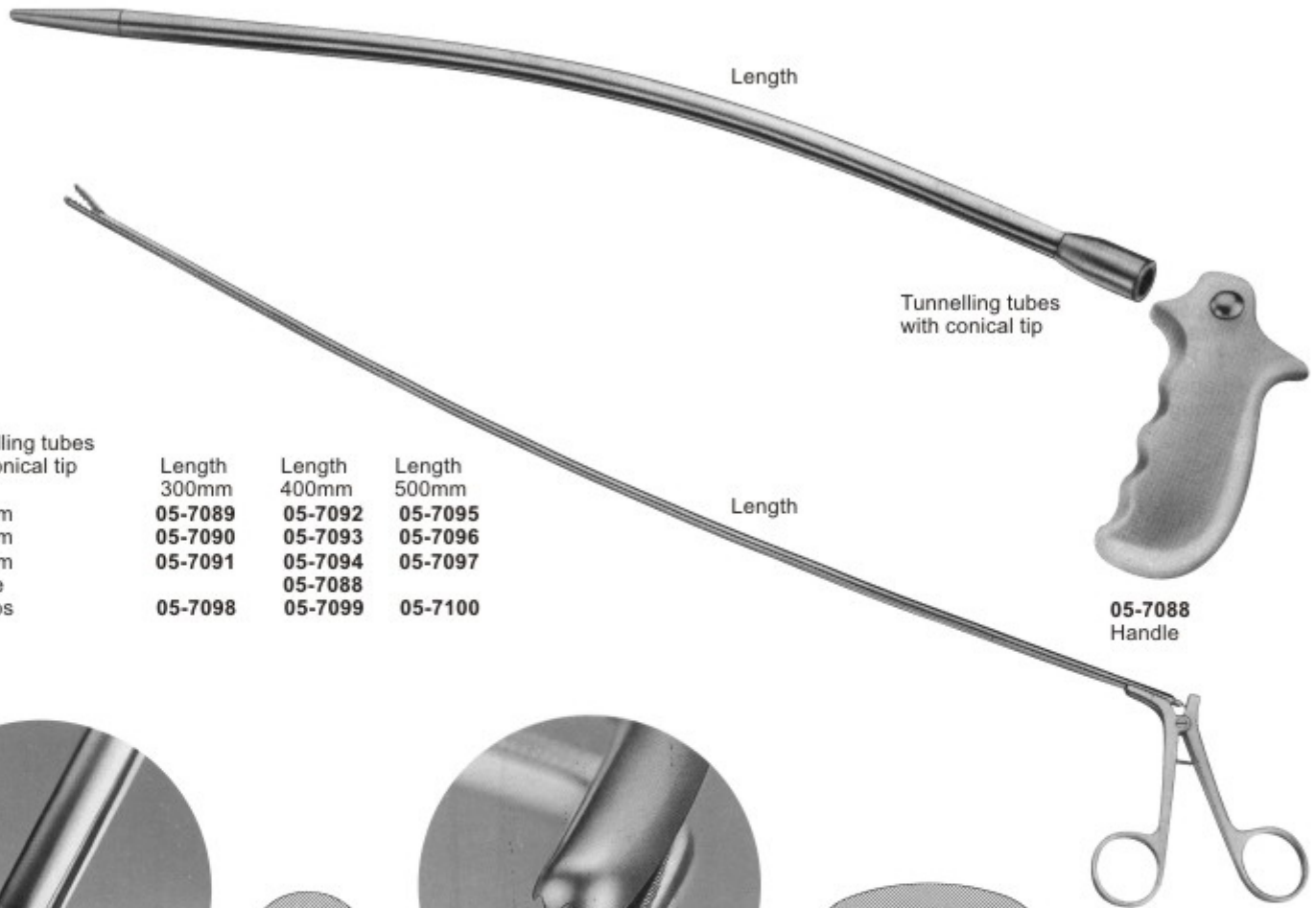

Tunnelling tubes with conical tip

	Length 300mm	Length 400mm	Length 500mm
∅ 12mm	05-7089	05-7092	05-7095
∅ 14mm	05-7090	05-7093	05-7096
∅ 17mm	05-7091	05-7094	05-7097
Handle	05-7098	05-7099	05-7100
Forceps			

Tunnelling tubes with conical tip

05-7088 Handle

05-7098 Forceps

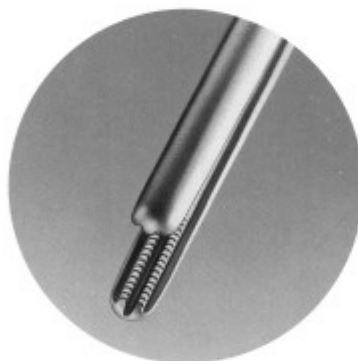

DE BAKEY
05-7101
1 : 2 rows of teeth

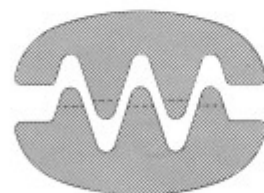
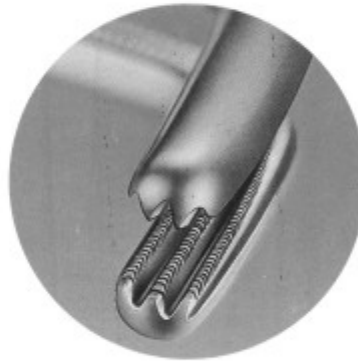

DE BAKEY
05-7102
2 : 3 rows of teeth

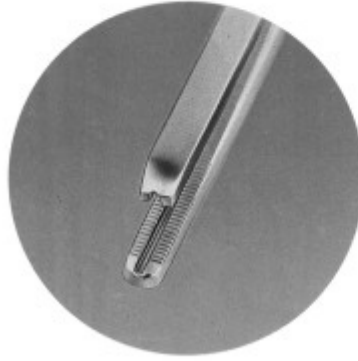

COOLEY
05-7103
2 : 2 rows of teeth

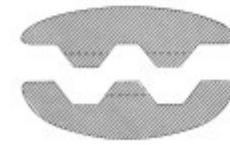
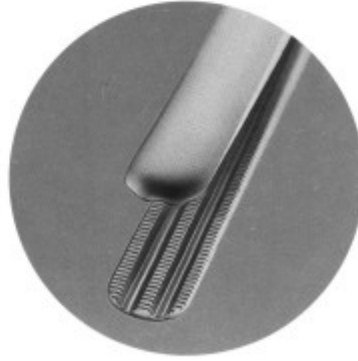

DARDIK
05-7104
2 : 3 rows of teeth

Atraumata Ultra-Light-Forceps

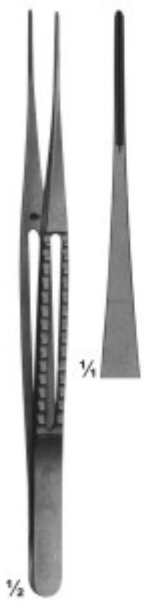

05-7105
Width of jaws 1.2 mm
Length 150mm

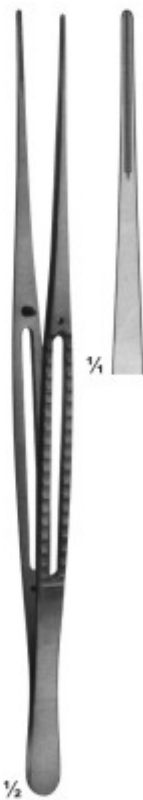

05-7106
Width 1,5 mm
Lenght 200 mm



05-7107
Width 1,5 mm
Lenght 240 mm



05-7108
Width 1,5 mm
Lenght 300 mm

Atraumata Dissecting Forceps

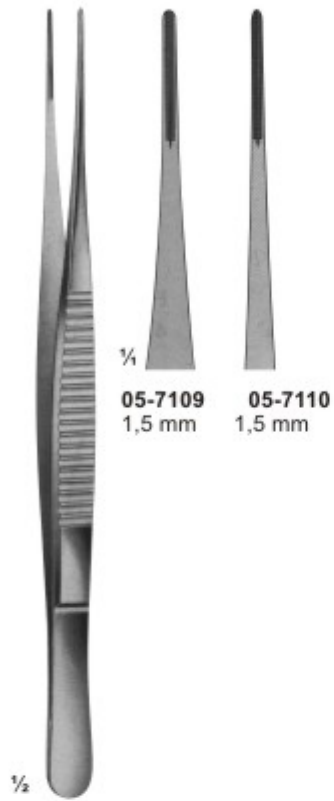

05-7109 1,5 mm
05-7110 1,5 mm

05-7109 - 05-7110
DE BAKEY
150 mm
300 mm

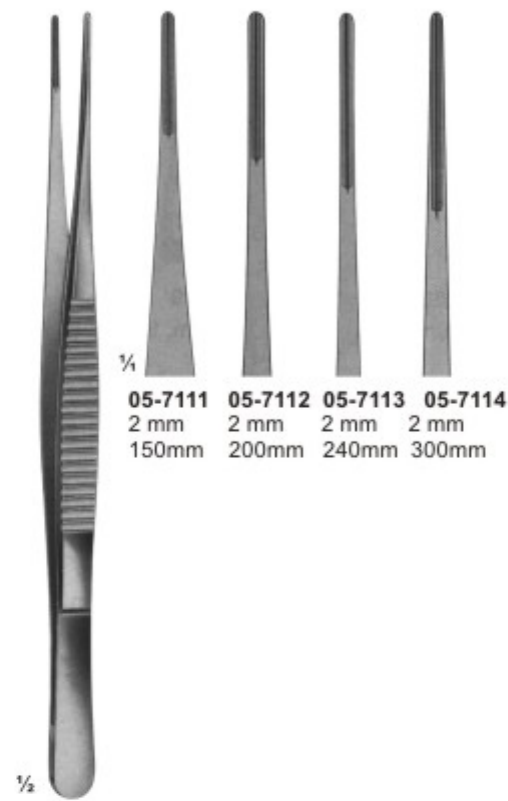

05-7111 2 mm 150mm
05-7112 2 mm 200mm
05-7113 2 mm 240mm
05-7114 2 mm 300mm

05-7111 - 05-7114
DE BAKEY

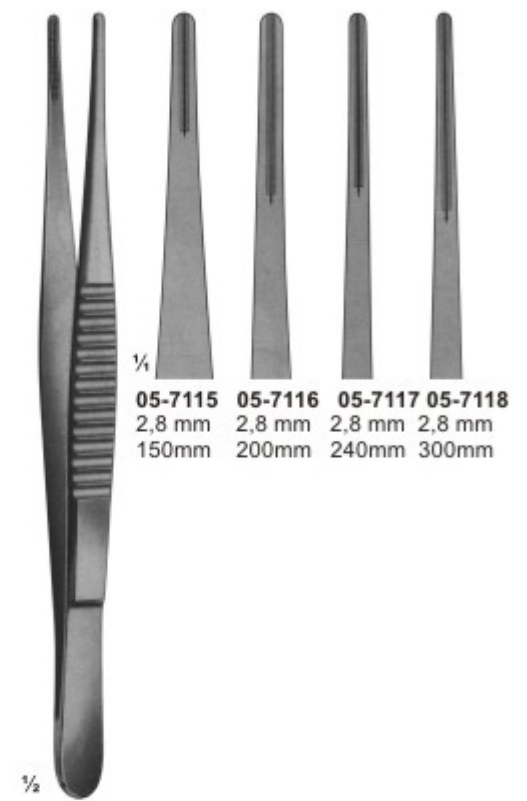

05-7115 2,8 mm 150mm
05-7116 2,8 mm 200mm
05-7117 2,8 mm 240mm
05-7118 2,8 mm 300mm

05-7115 - 05-7118
DE BAKEY



05-7119 3,3mm 200mm
05-7120 3,5 mm 300mm

05-7121 3,5 mm 240mm

05-7119 - 05-7121
DE BAKEY

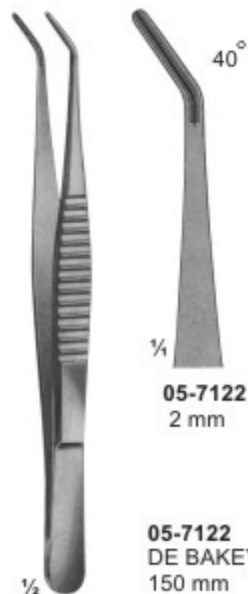

05-7122 2 mm

05-7122
DE BAKEY
150 mm

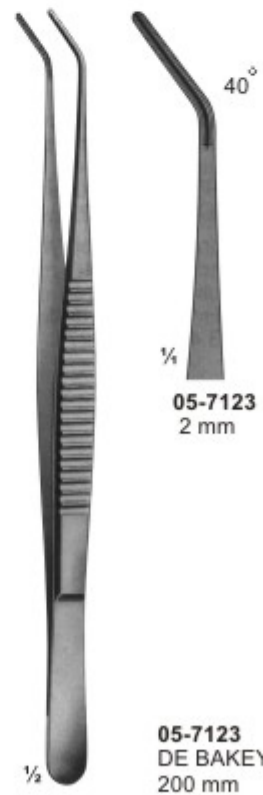

05-7123 2 mm

05-7123
DE BAKEY
200 mm

Atraumata Ring Handle Bulldog Clamps

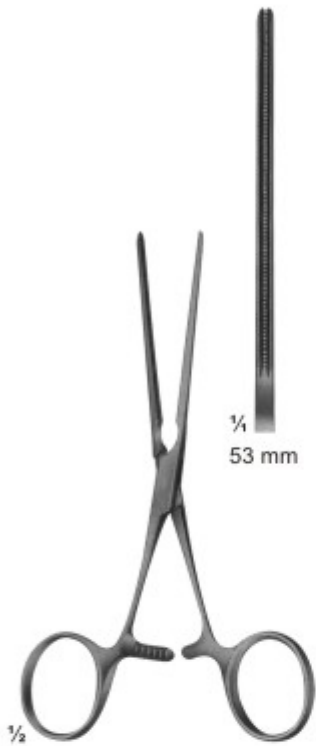

05-7124
DE-BAKEY
straight
130 mm



05-7125
DE-BAKEY
curved jaws
125 mm

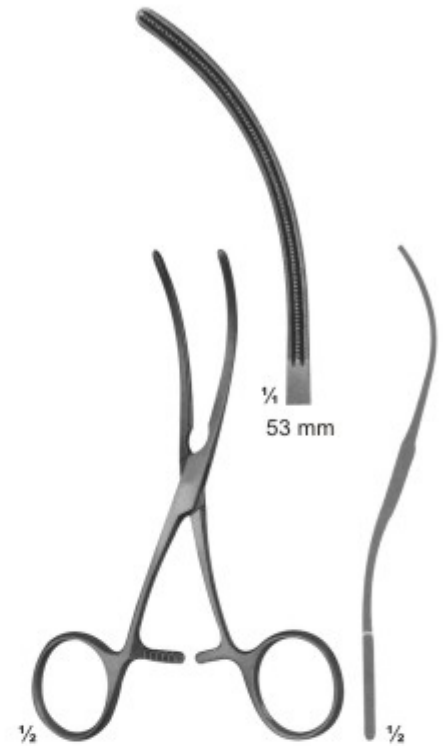

05-7126
DE-BAKEY
S-shaped curved
125 mm

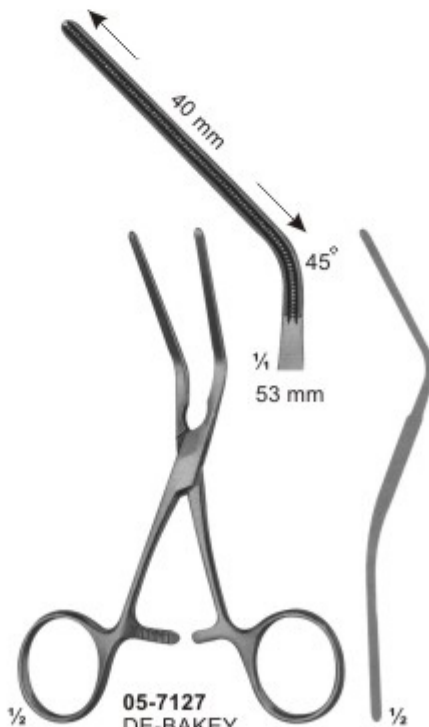

05-7127
DE-BAKEY
angled 45
125 mm

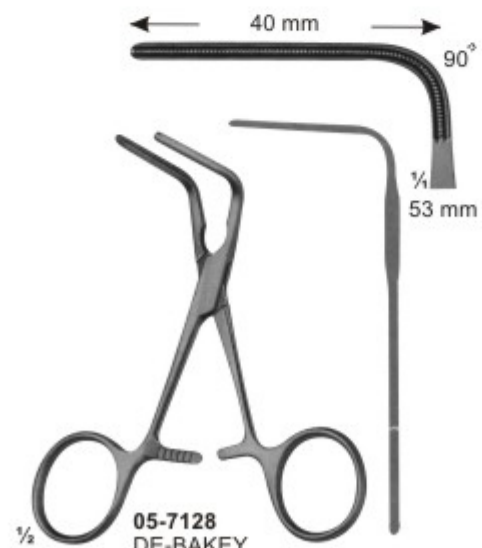

05-7128
DE-BAKEY
angled 90
105 mm

Atraumata Anastomosis and Multi-Purpose-Clamps for Neonatales

graduated



1/2

05-7129 - 05-7132
CASTANEDA



1/4

48 mm
05-7129
Length 105 mm

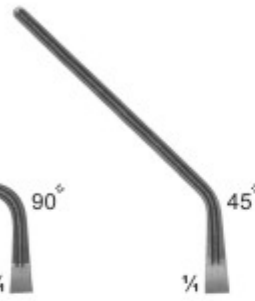

1/4

48 mm
05-7130
Length 120 mm



1/4

48 mm
05-7131
Length 120 mm



1/4

48 mm
05-7132
Length 125 mm

graduated



1/2

05-7133 - 05-7136
CASTANEDA



1/4

48 mm
05-7133
Length 155 mm



1/4

52 mm
05-7134
Length 155 mm



1/4

56 mm
05-7135
Length 155 mm



1/4

50 mm
05-7136
Length 155 mm

Atraumata Anastomosis-and Multi-Purpose Clamps-Pediatric types

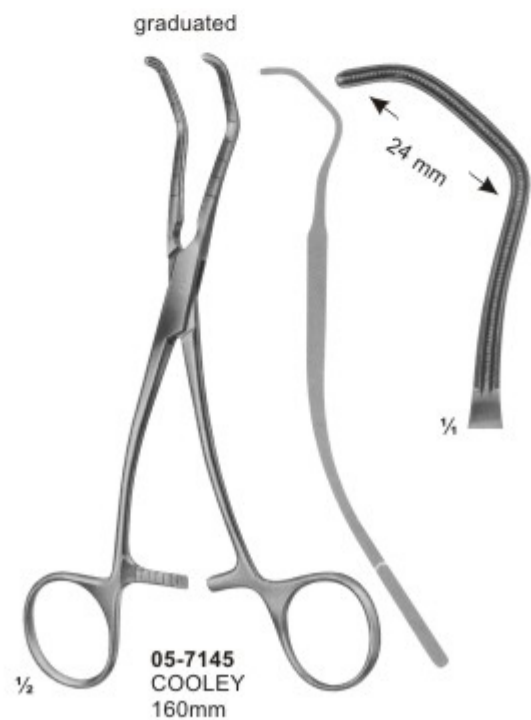
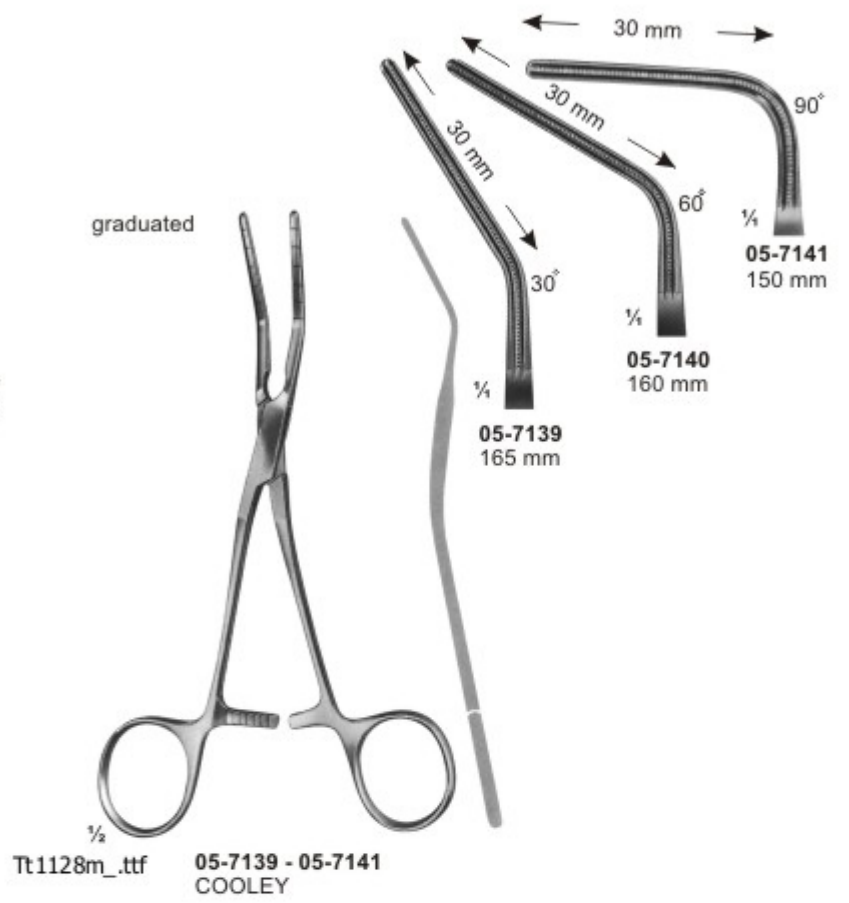
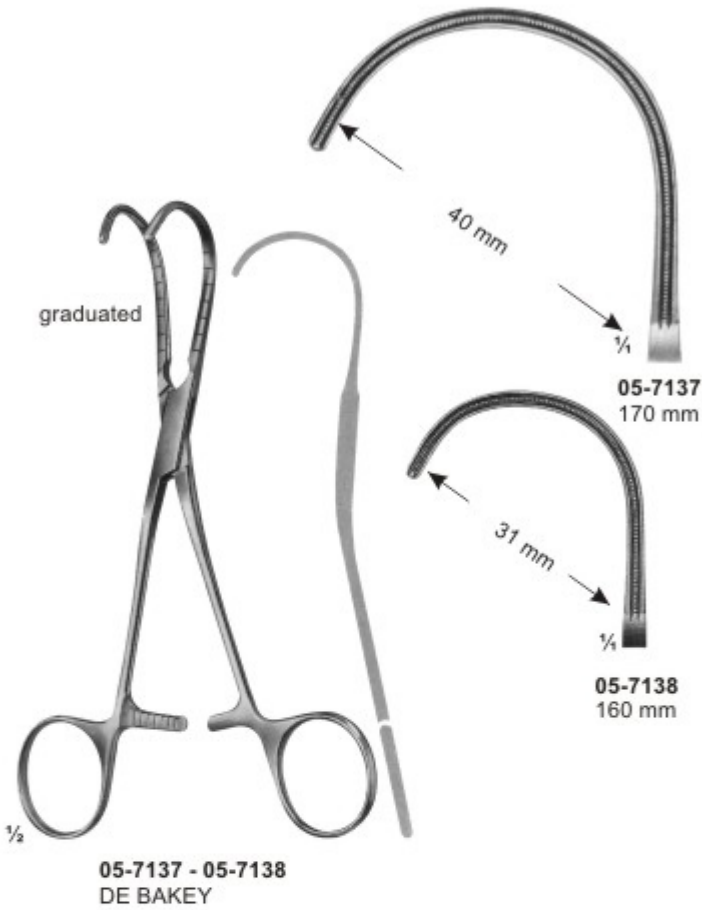

Atraumata Non-traumatic Haemostatic Forceps

Mosquito Forceps

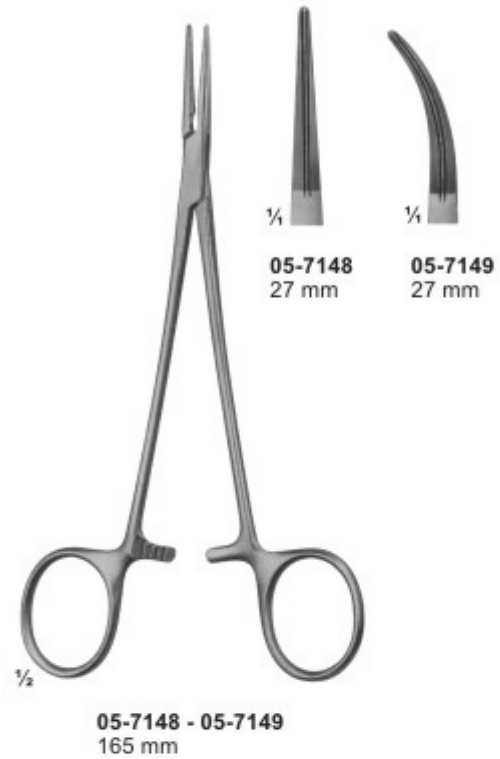
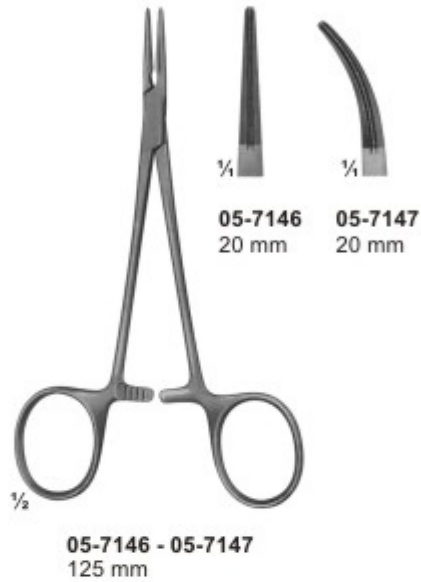

Atraumata Non-traumatic Haemostatic Forcep

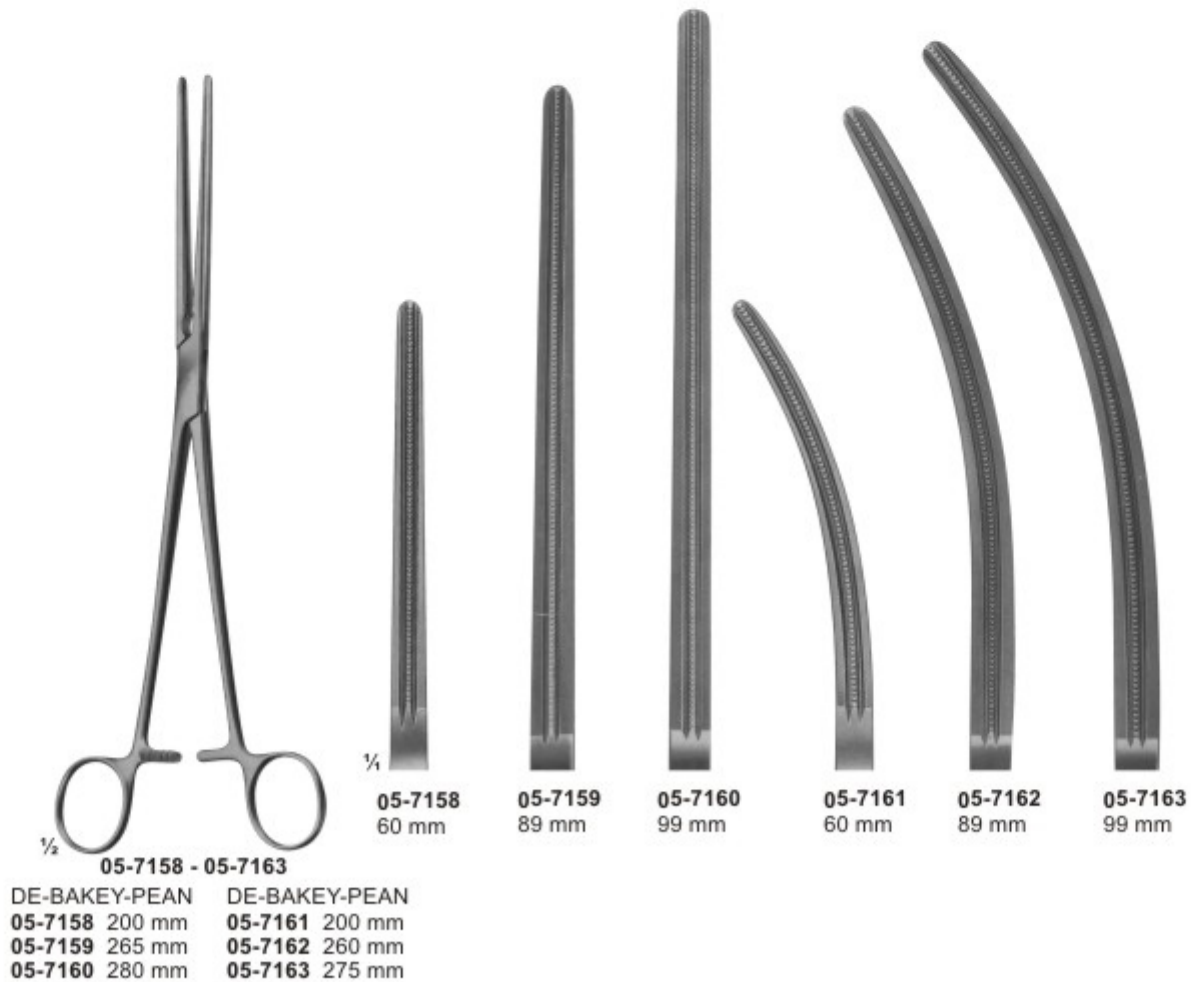

Atraumata Dissecting And Ligature Forceps Anastomosis Clamps

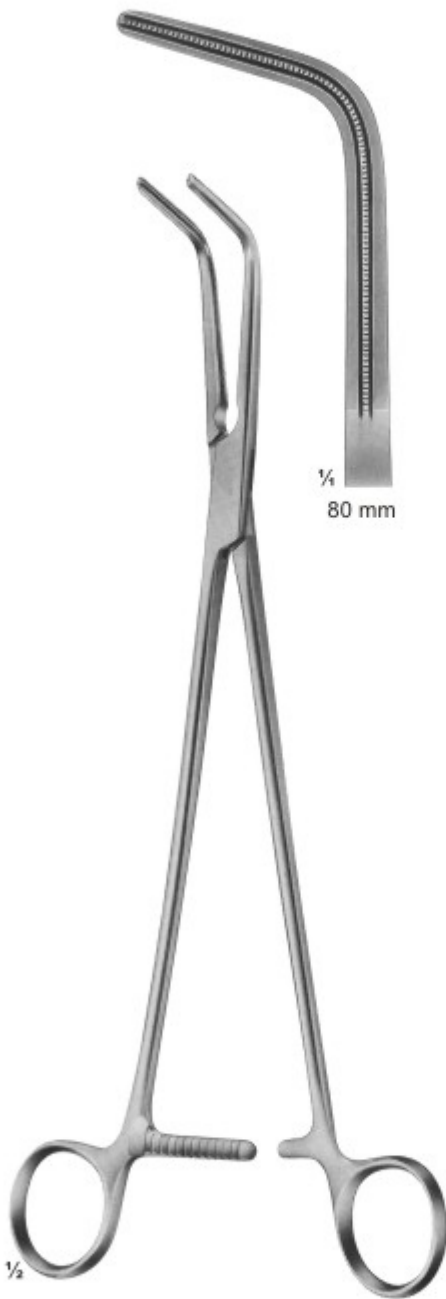

05-7164
DE-BAKEY-MIXTER
285 mm

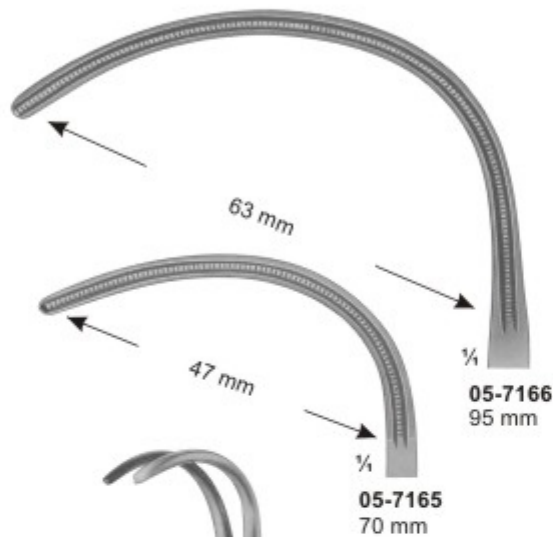

05-7165 - 05-7166
GLOVER
05-7165 195mm
05-7166 210mm

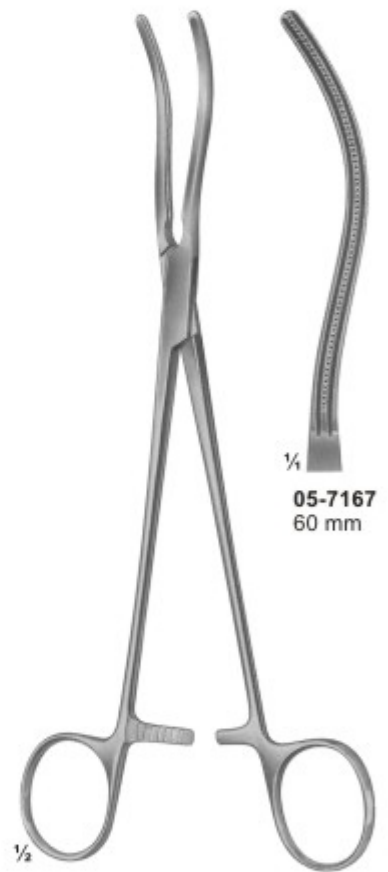

05-7167
GLOVER
220 mm

Atraumata Anastomosis, Vena-Cava Clamps

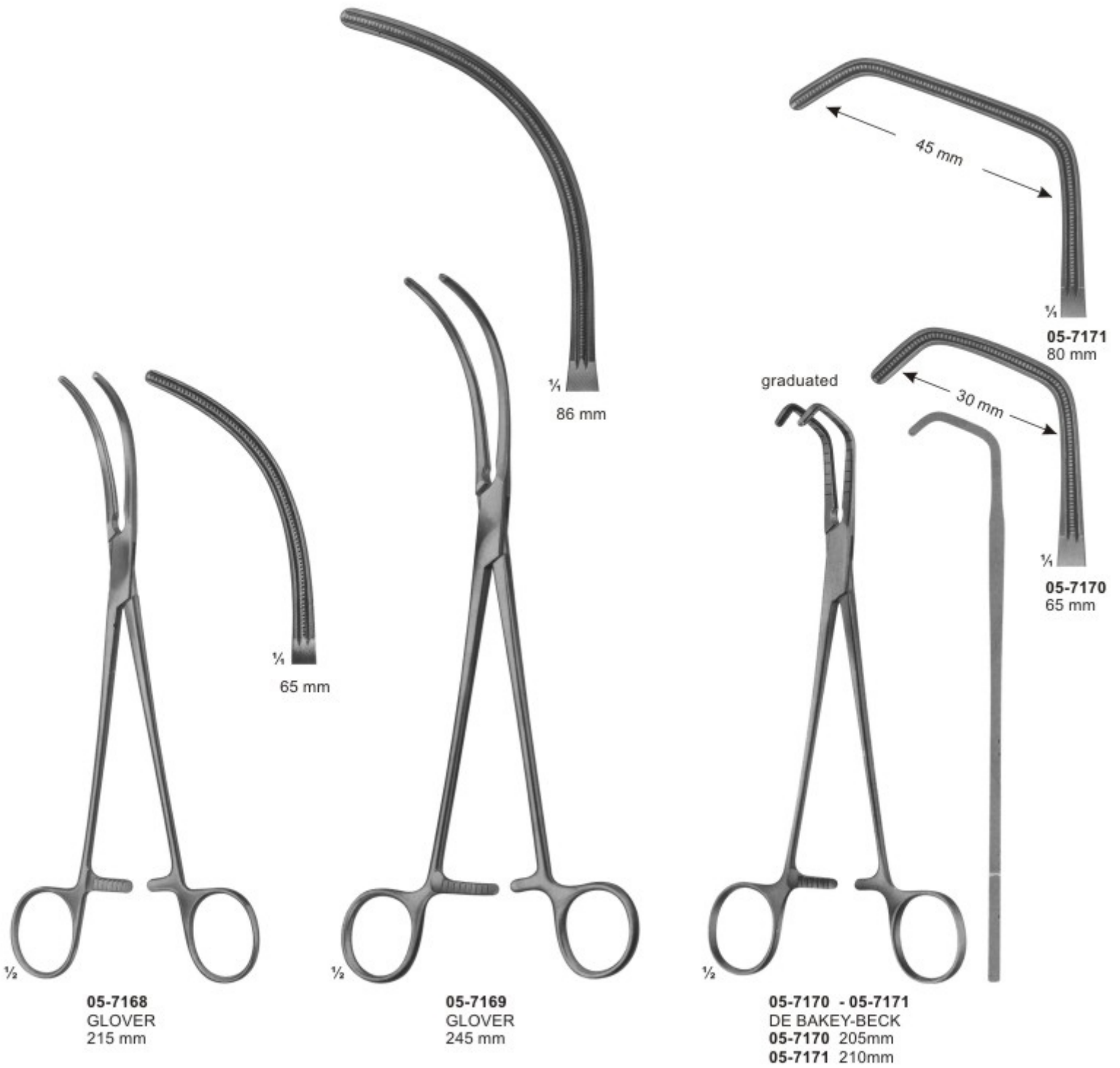

Atraumata Vena-Cava Clamps And Tangential Occlusion Clamps



05-7172 - 05-7175
DE BAKEY-HARKEN
05-7172 - 255 mm
05-7173 - 245 mm
05-7174 - 245 mm
05-7175 - 245 mm



05-7176 - 05-7180 DE BAKEY	Total Length:	220 mm	265 mm	270 mm	270 mm	280 mm
	Length of jaws:	85 mm	95 mm	99 mm	103 mm	119 mm

Atraumata Tangential Occlusion And Coarctation Clamps



05-7181 - 05-7183
DE BAKEY-SATINSKY

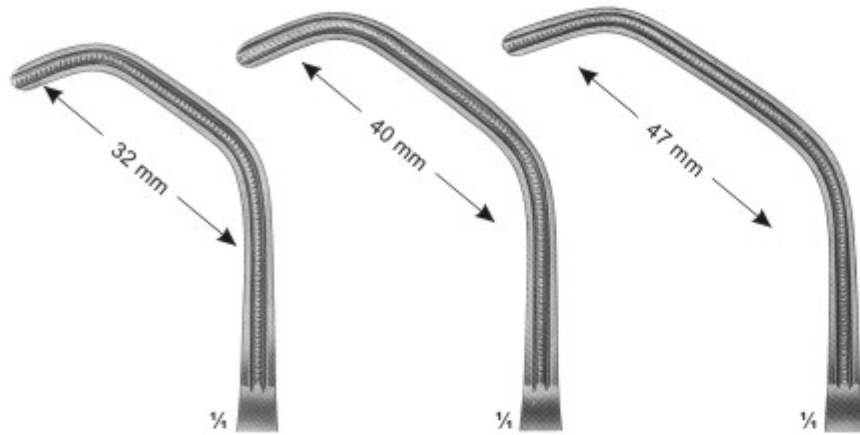

05-7181
68 mm
Length 235mm

05-7182
76 mm
Length 240mm

05-7183
84 mm
Length 245mm



05-7184 - 05-7185
DE BAKEY
05-7184 170mm
05-7185 165mm

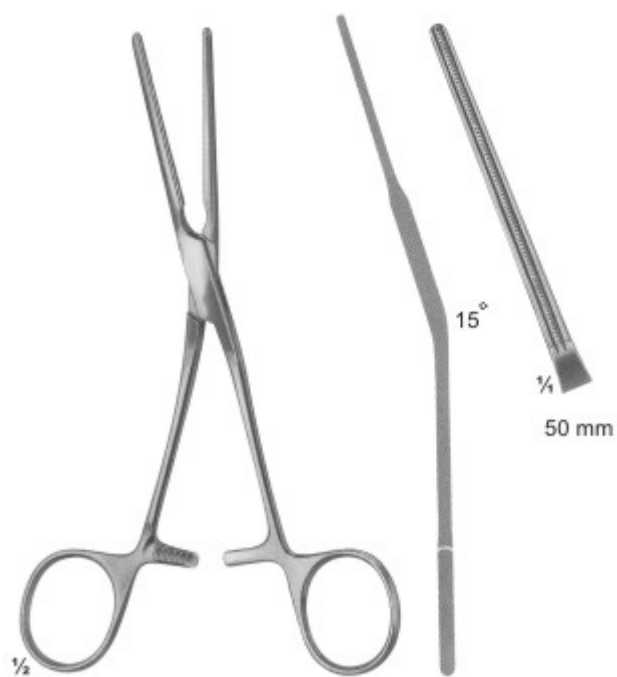

05-7186
DE BAKEY
165 mm

Atraumata Coarctation Clamps, Patent-Ducts Clamps

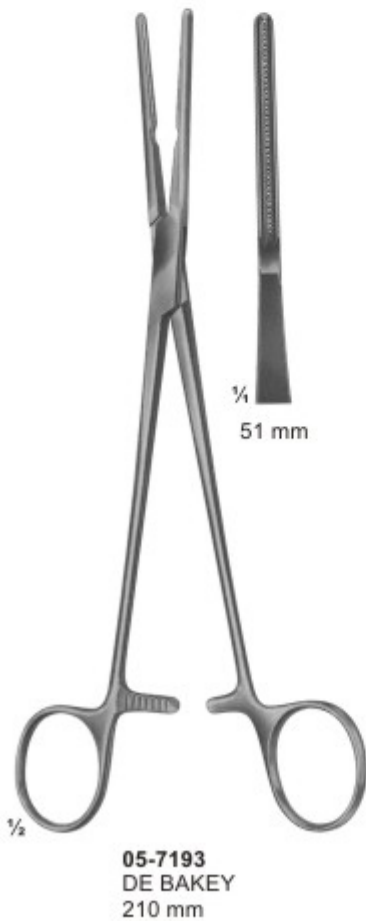
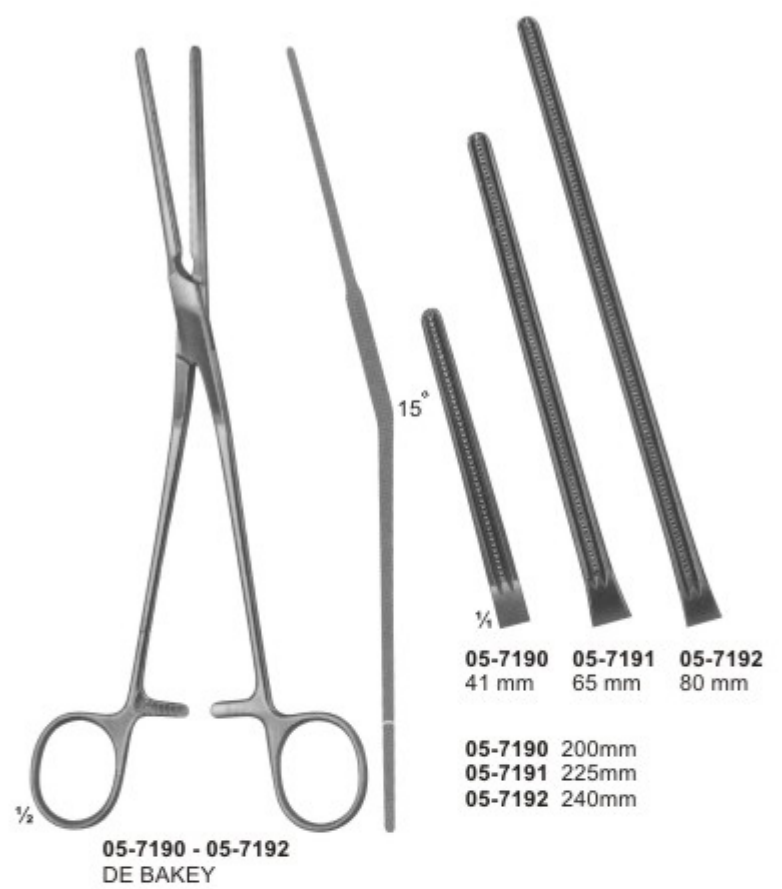
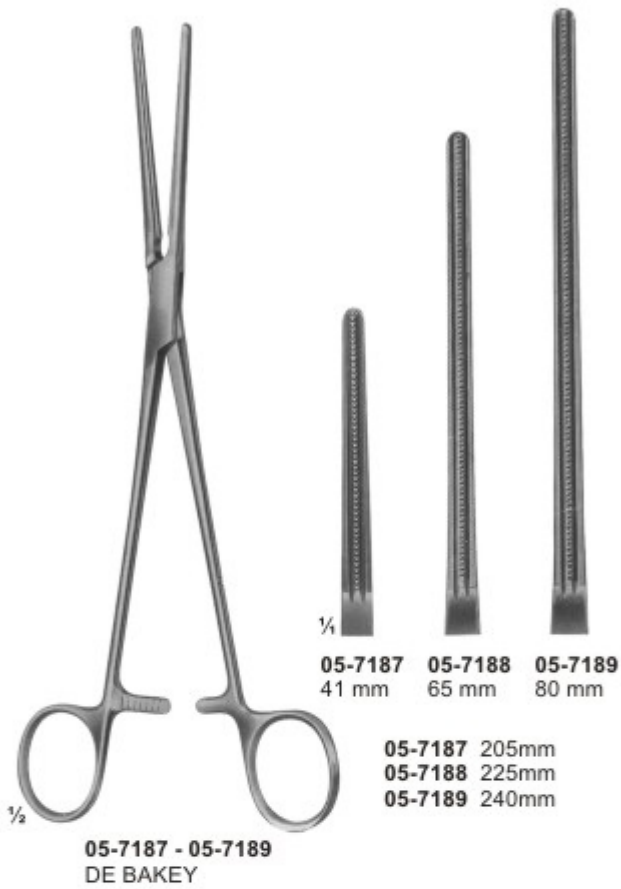

Atraumata Peripheral-Vascular Clamps

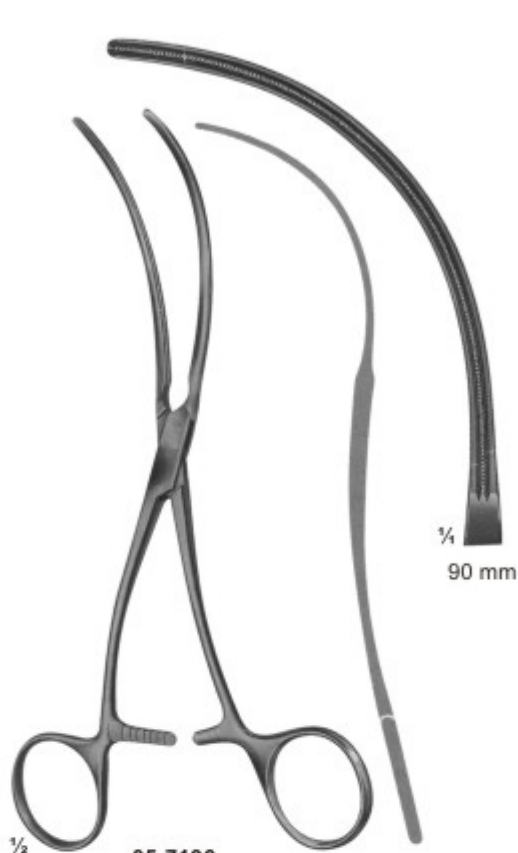

05-7196
DE BAKEY
190 mm

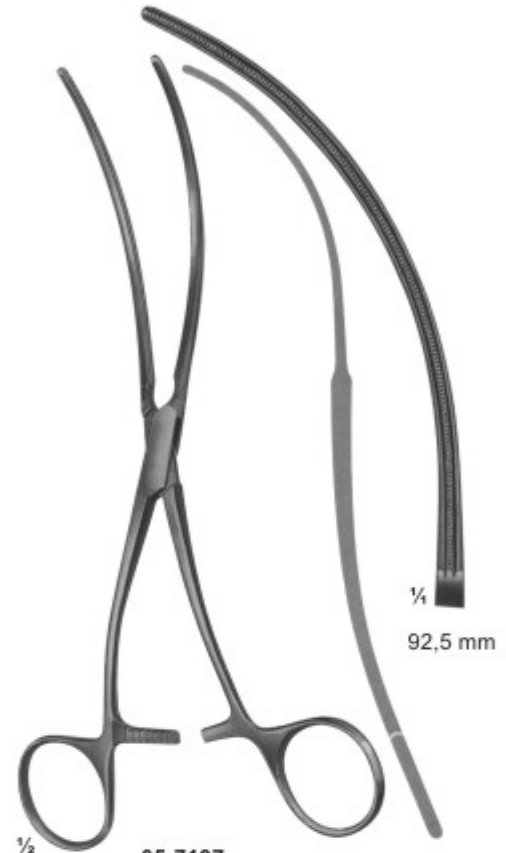

05-7197
DE BAKEY
200 mm

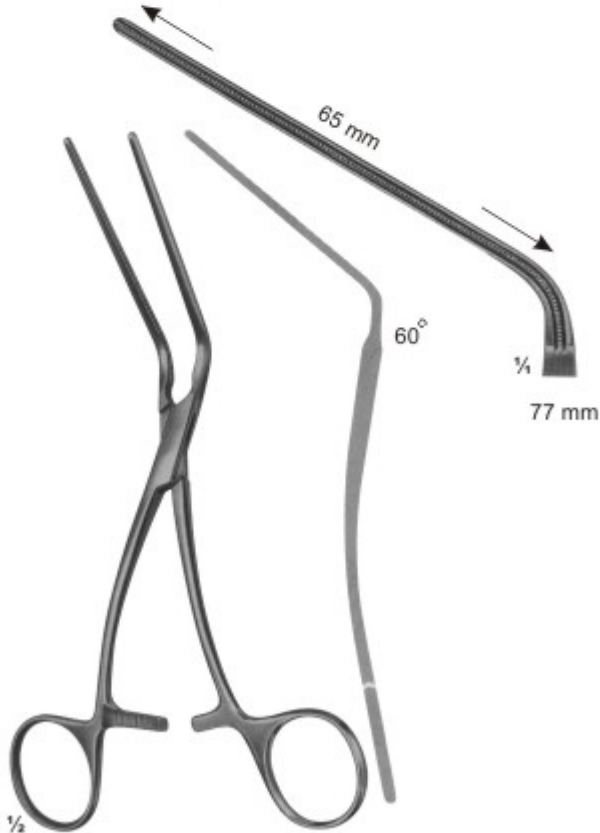

05-7198
DE BAKEY
180 mm

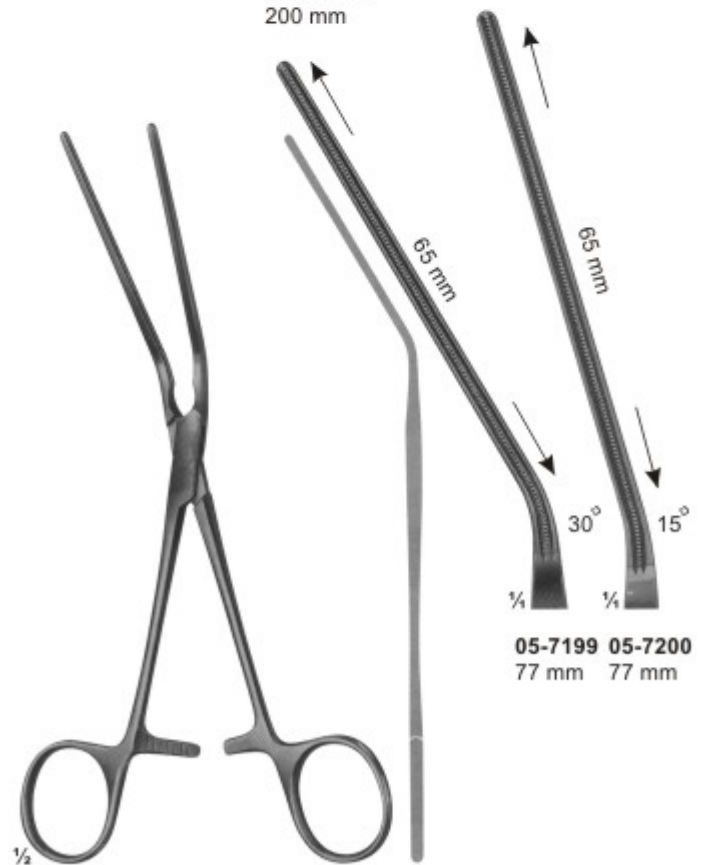

05-7199 - 05-7200
LELAND-JONES
190 mm

Atraumata Peripheral Vascular And Anastomosis Clamps



05-7201
LELAND-JONES
195 mm



05-7202
DE BAKAY
200 mm

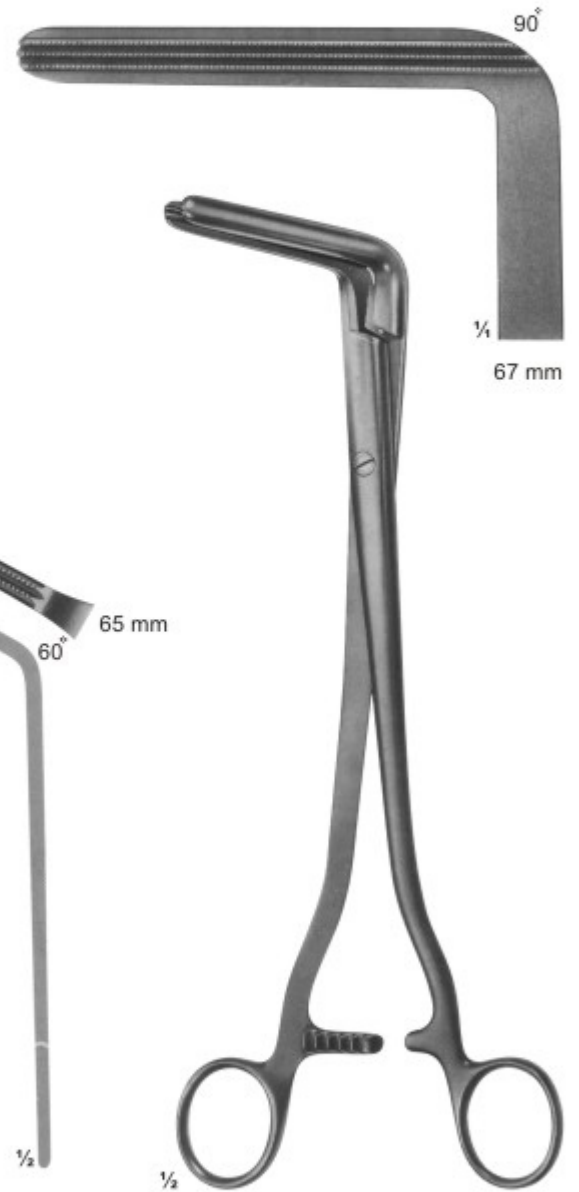

05-7203
WERTHEIM
250 mm

Atraumata Anastomosis And Ascending Aorta Cross Clamps



05-7204
78 mm

05-7205
88 mm

05-7206
98 mm

05-7204 - 05-7206
DICK
05-7204 255mm
05-7205 265mm
05-7206 275mm

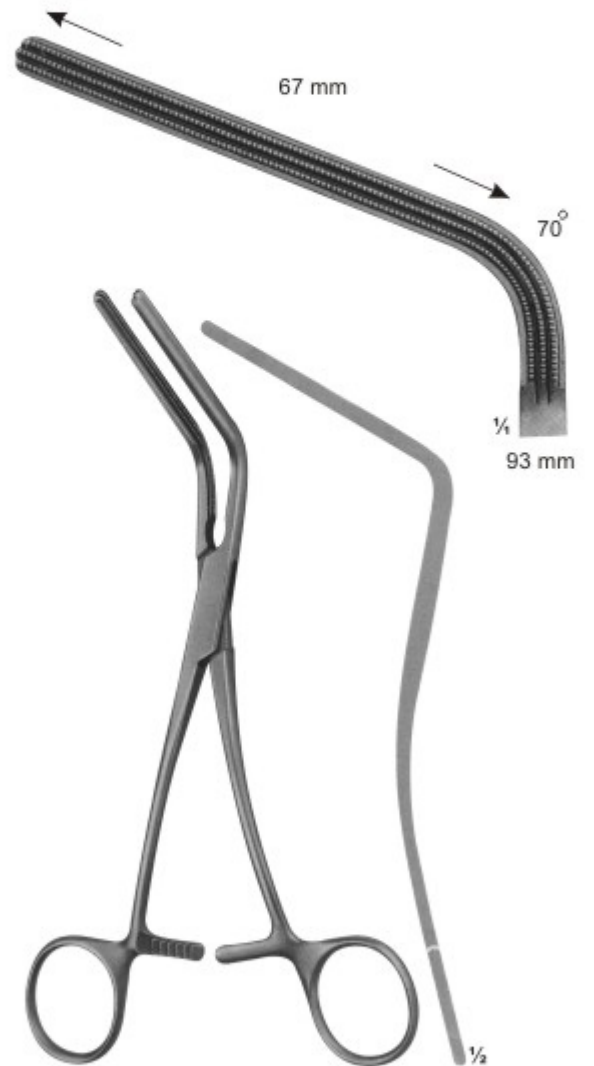

05-7207
MORRIS
175 mm

Atraumata Ascending Aorta Cross, Bronchus Clamps

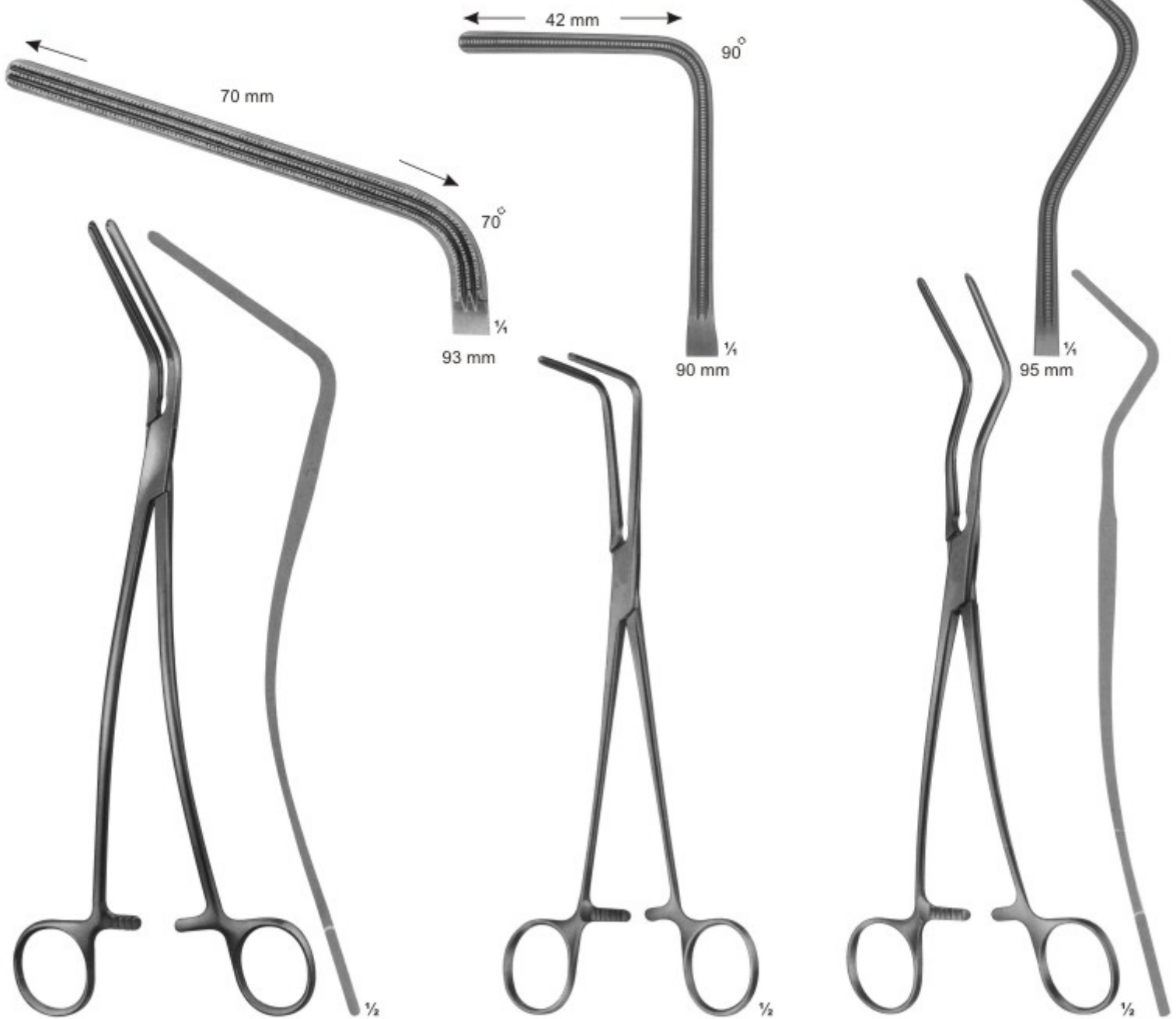

05-7208
DE BAKKEY(Morris Modif)
240 mm

05-7209
LEES
220 mm

05-7210
LEES
245 mm

Atraumata Aorta-Aneurysm Clamps

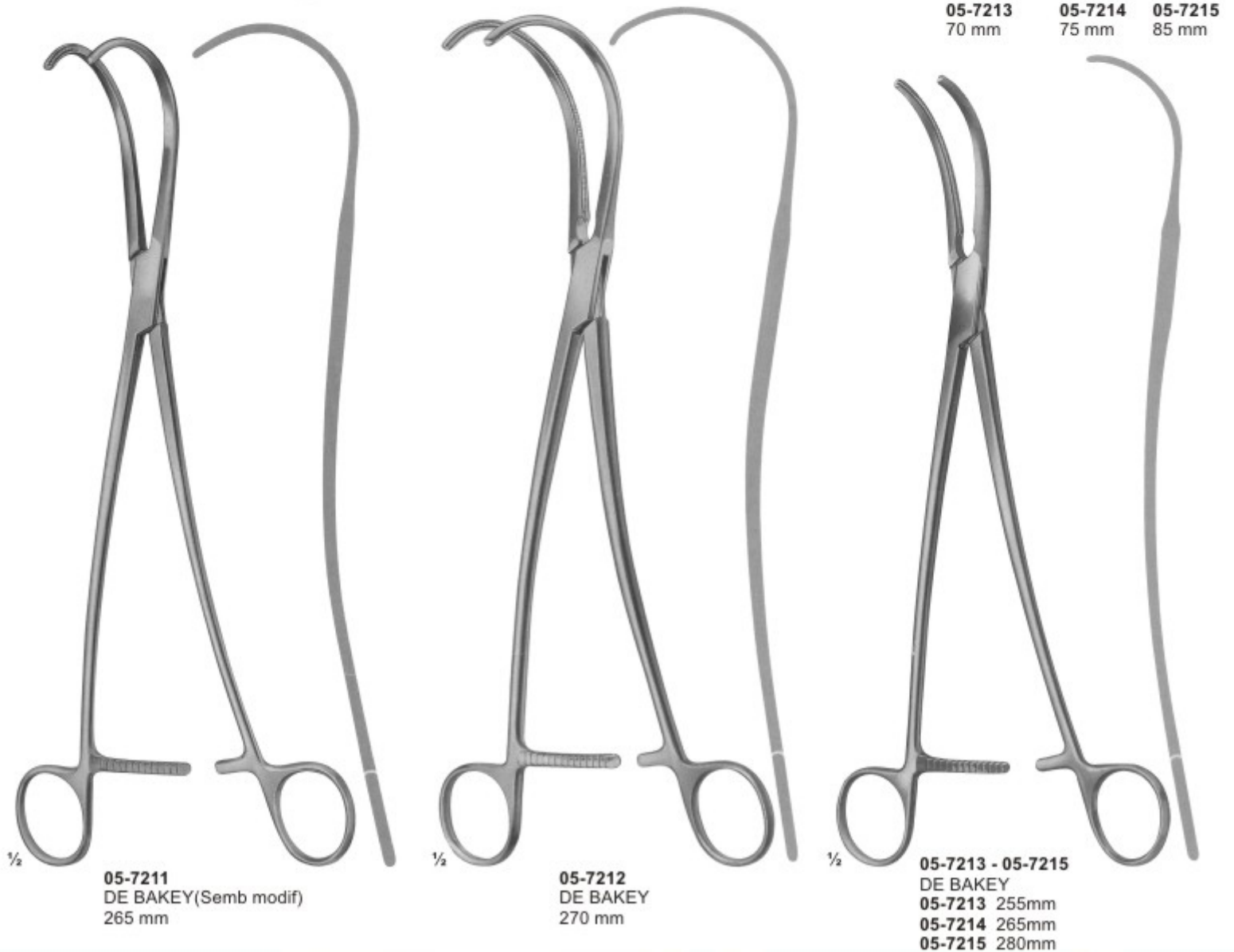
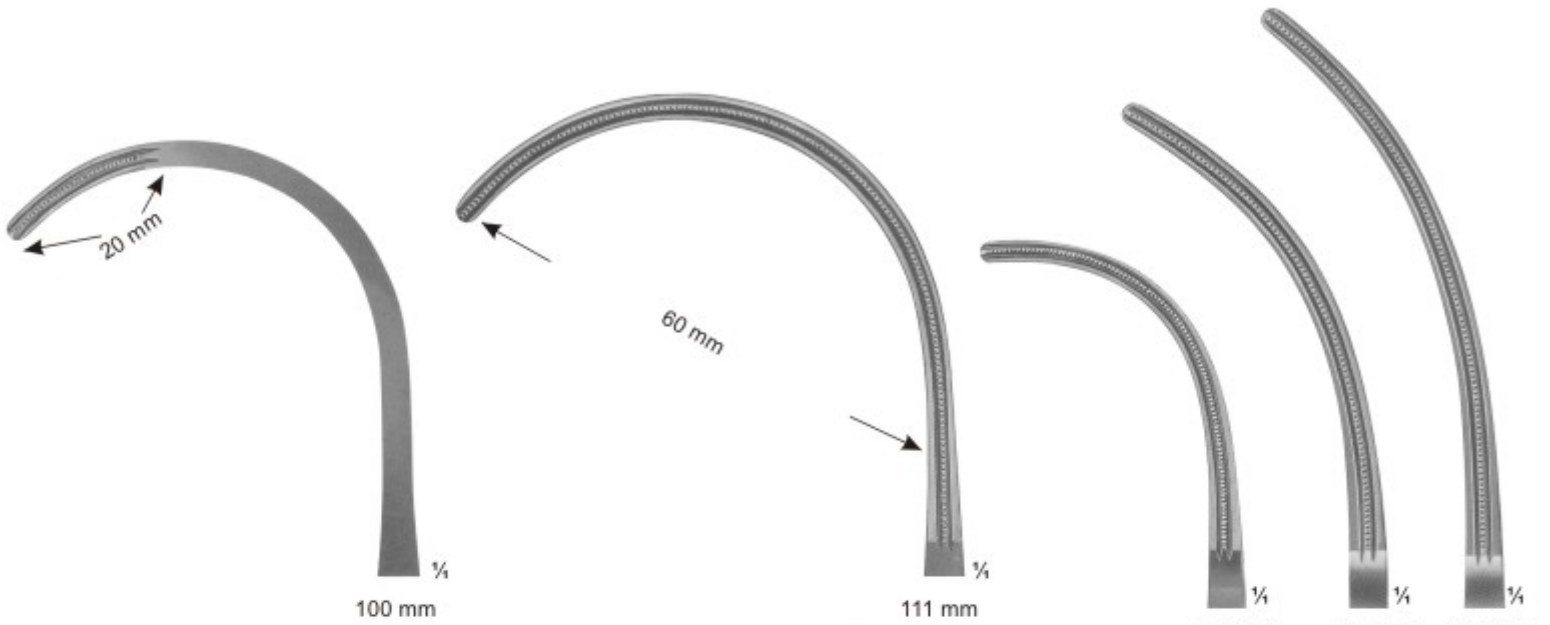

Atraumata Aorta-Aneurysm Clamps



2.3 Teeth Rows



05-7216 05-7217 05-7218 05-7219
95 mm 110 mm 130 mm 140 mm

05-7216 - 05-7219
DE BAKEY
05-7216 250mm
05-7217 300mm
07-7218 315mm
07-7219 330mm



05-7220
DE BAKEY
300 mm

Atraumata Aorta Clamps

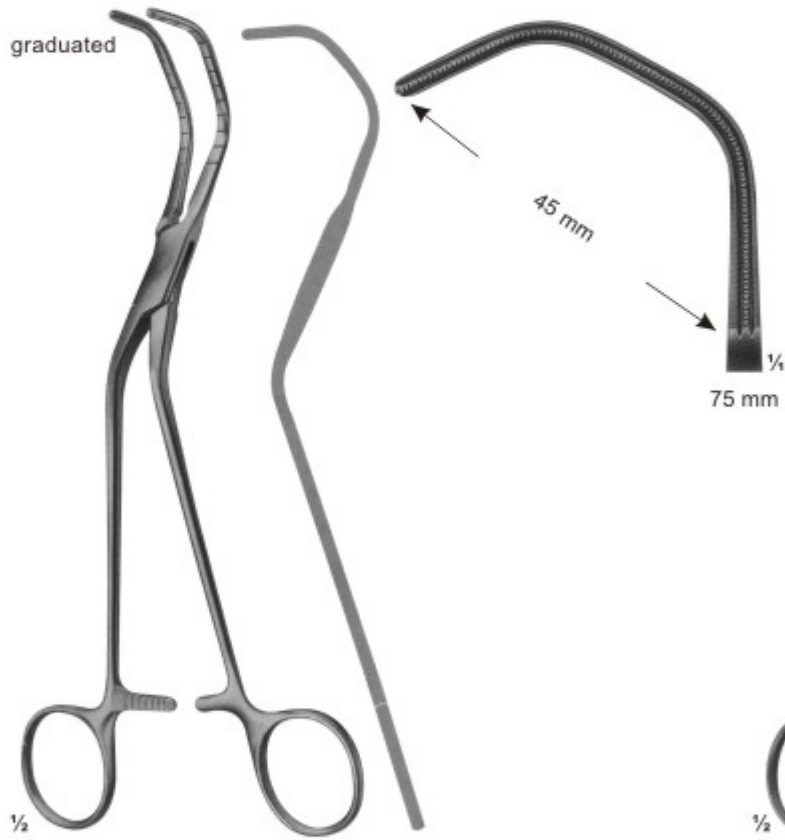

05-7221
DIETRICH
210 mm

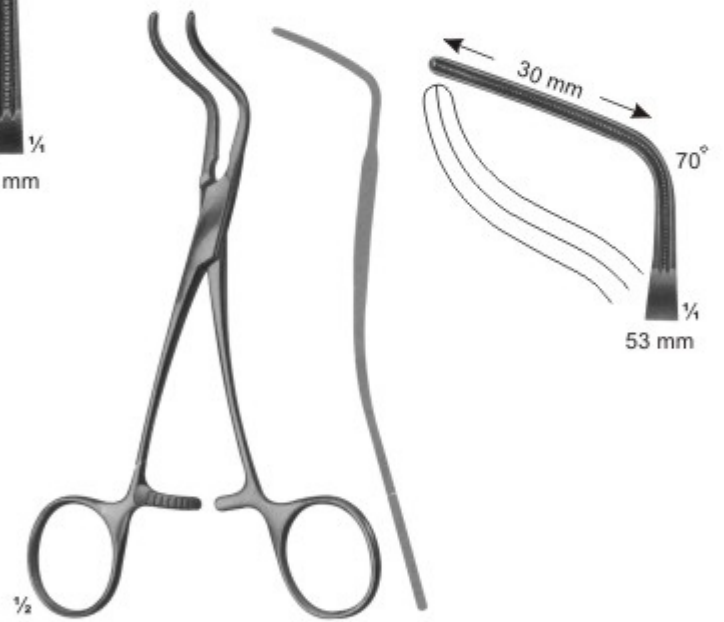

05-7222
SUBRAMANIAN(Modif)
155 mm

Atraumata Aorta Clamps

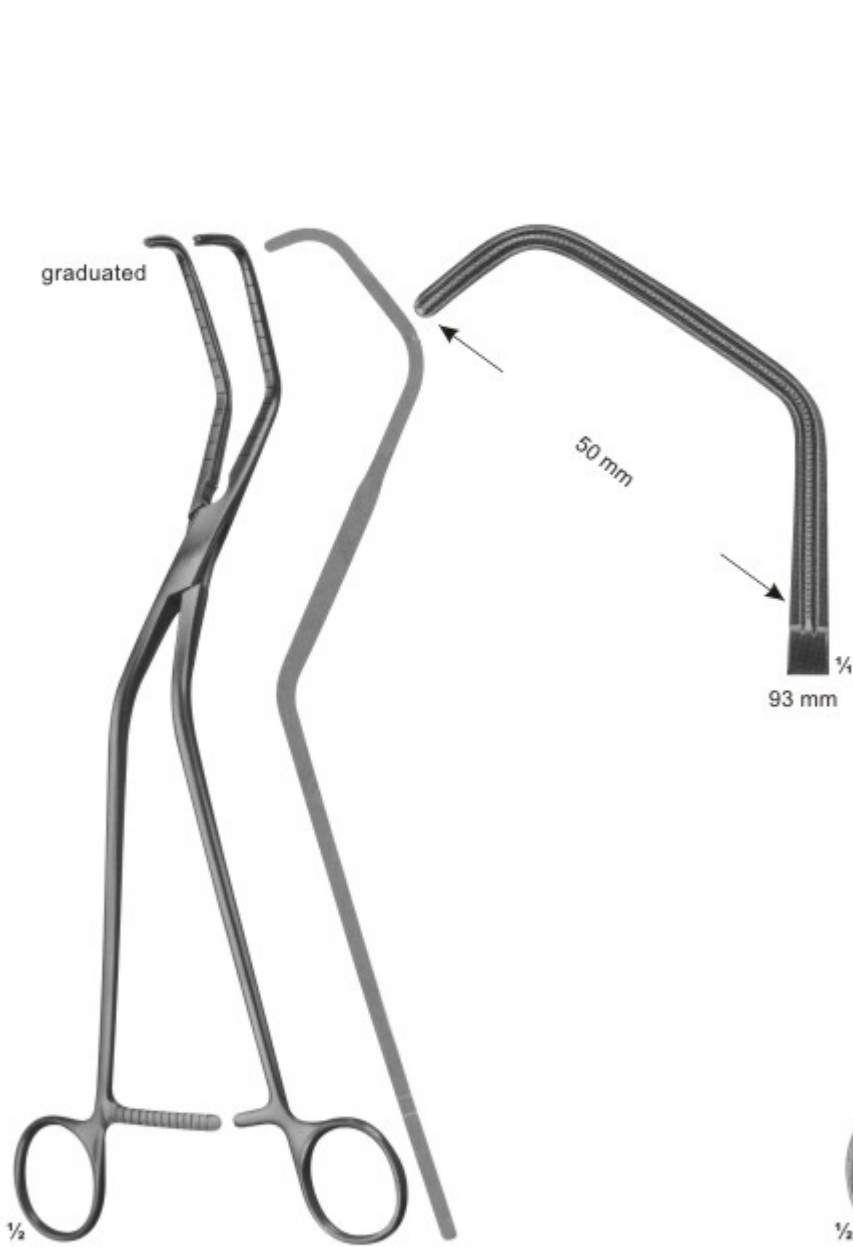

05-7223
OCHSNER
260 mm

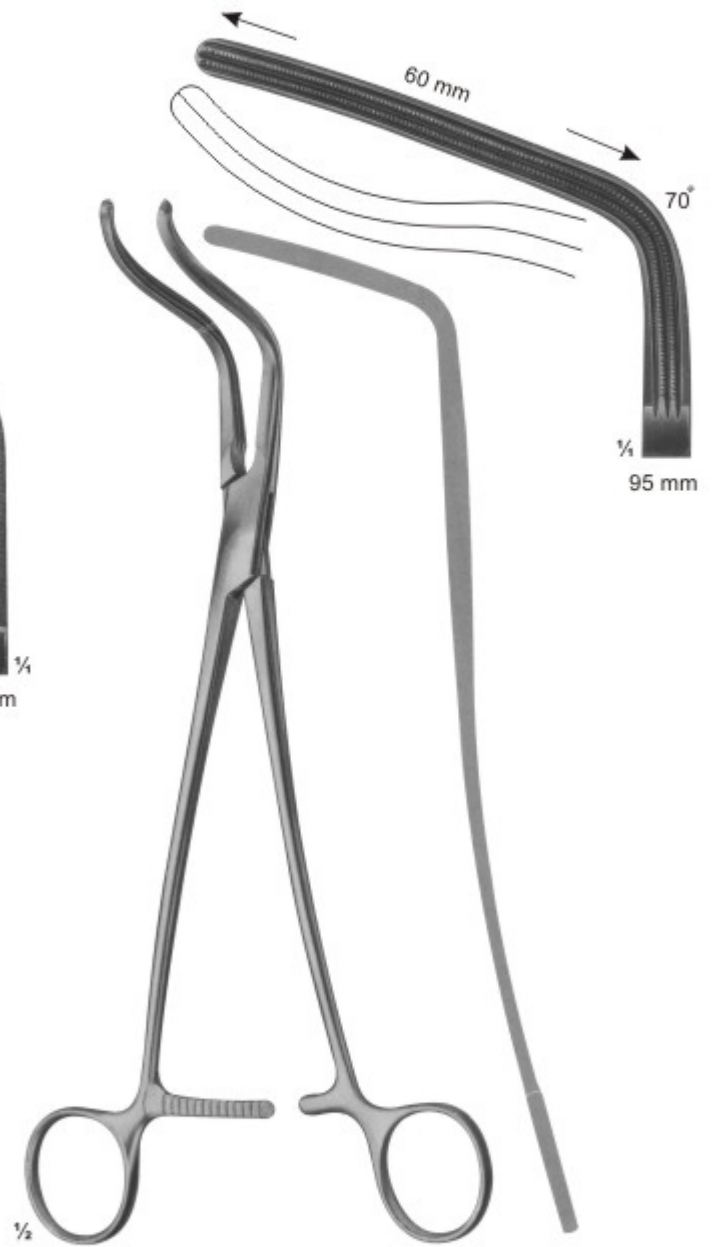

05-7224
DE BAKEY
265 mm

Atraumata Aorta-Anastomosis Clamps



L
05-7225
WEBER
260 mm



R
05-7226
WEBER
260 mm

Multi-Purpose Clamps



1/2 05-7227 - 05-7230
DE BAKEY

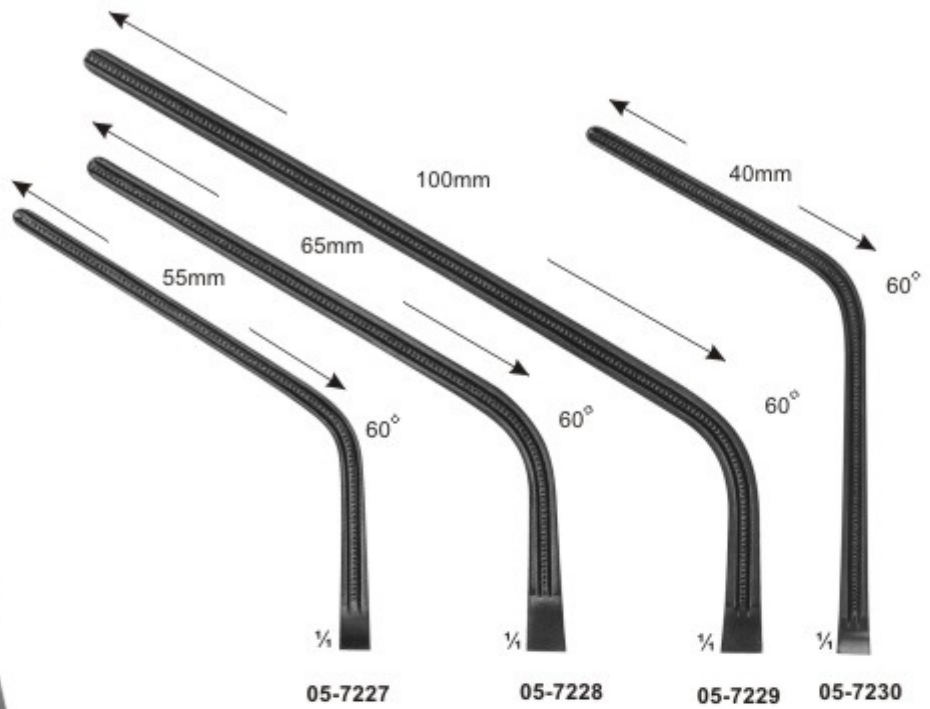

Total Length:	230 mm	280 mm	305 mm	240 mm
Length of jaws:	85 mm	100 mm	135 mm	93 mm



1/2 05-7231 - 05-7234
DE BAKEY

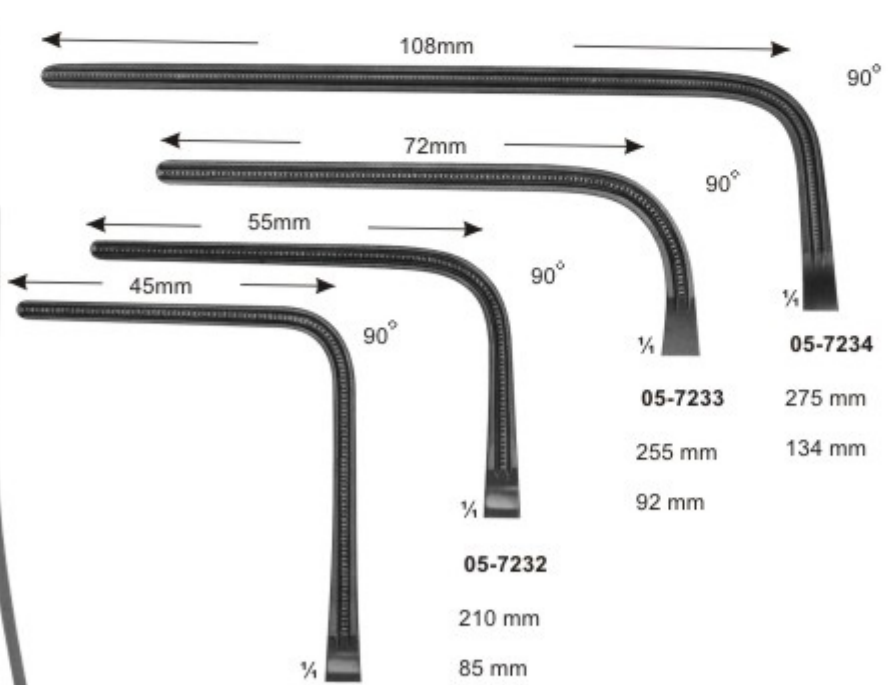

Total Length:	225 mm	275 mm	255 mm	92 mm
Length of jaws:	93 mm	134 mm	85 mm	

Ring Handle Bulldog Clamps Anastomosis Clamps, Pediatric Types



05-7235
50mm

05-7236
50mm

05-7235 - 05-7236
COOLEY
125 mm, 115 mm



05-7237
COOLEY
100 mm

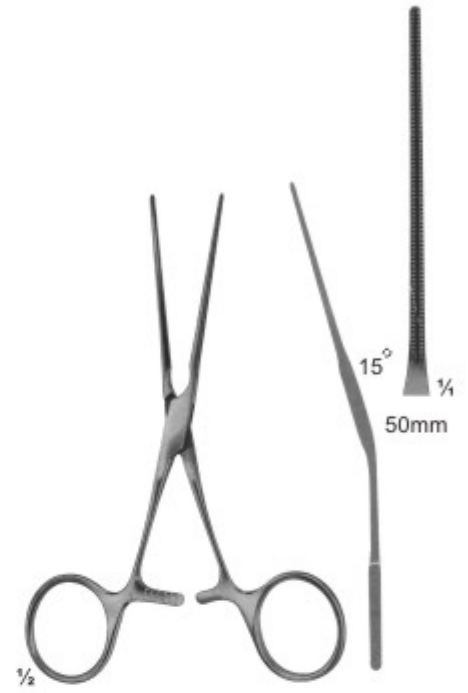

05-7238
COOLEY
125 mm

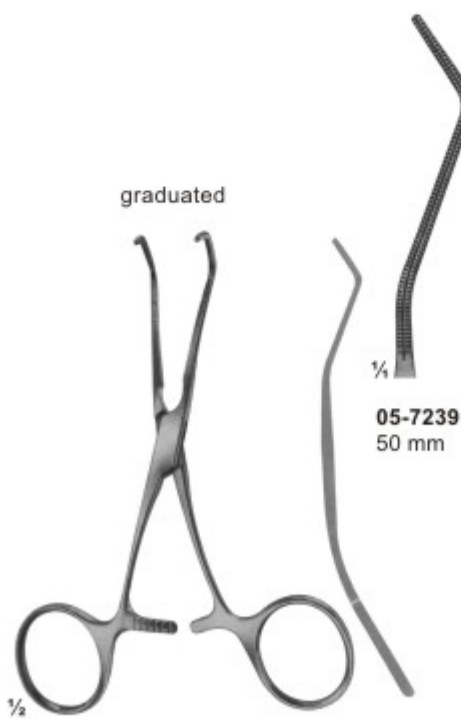

graduated

05-7239
50 mm

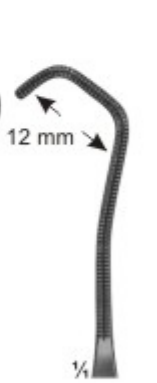

05-7240
50 mm

05-7239 - 05-7240
COOLEY
120 mm, 115 mm

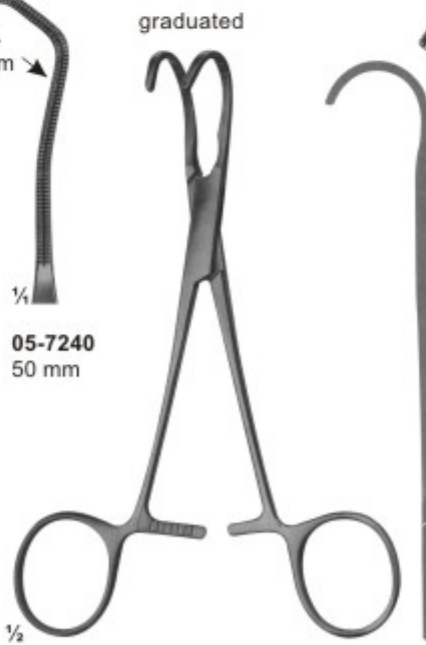

graduated

05-7241 - 05-7242
COOLEY-BECK
150 mm, 155 mm

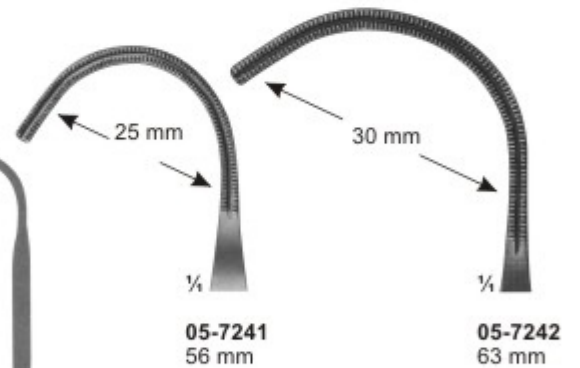

05-7241
56 mm

05-7242
63 mm

Anastomosis Clamps, Pediatric Types

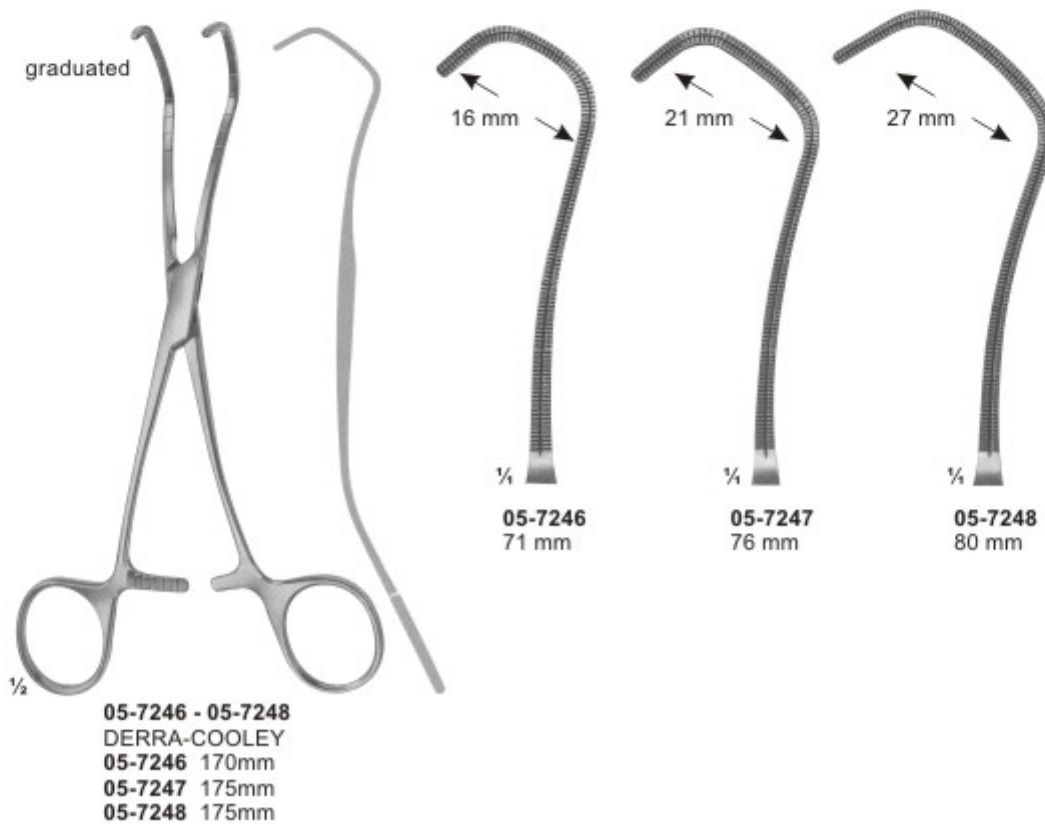
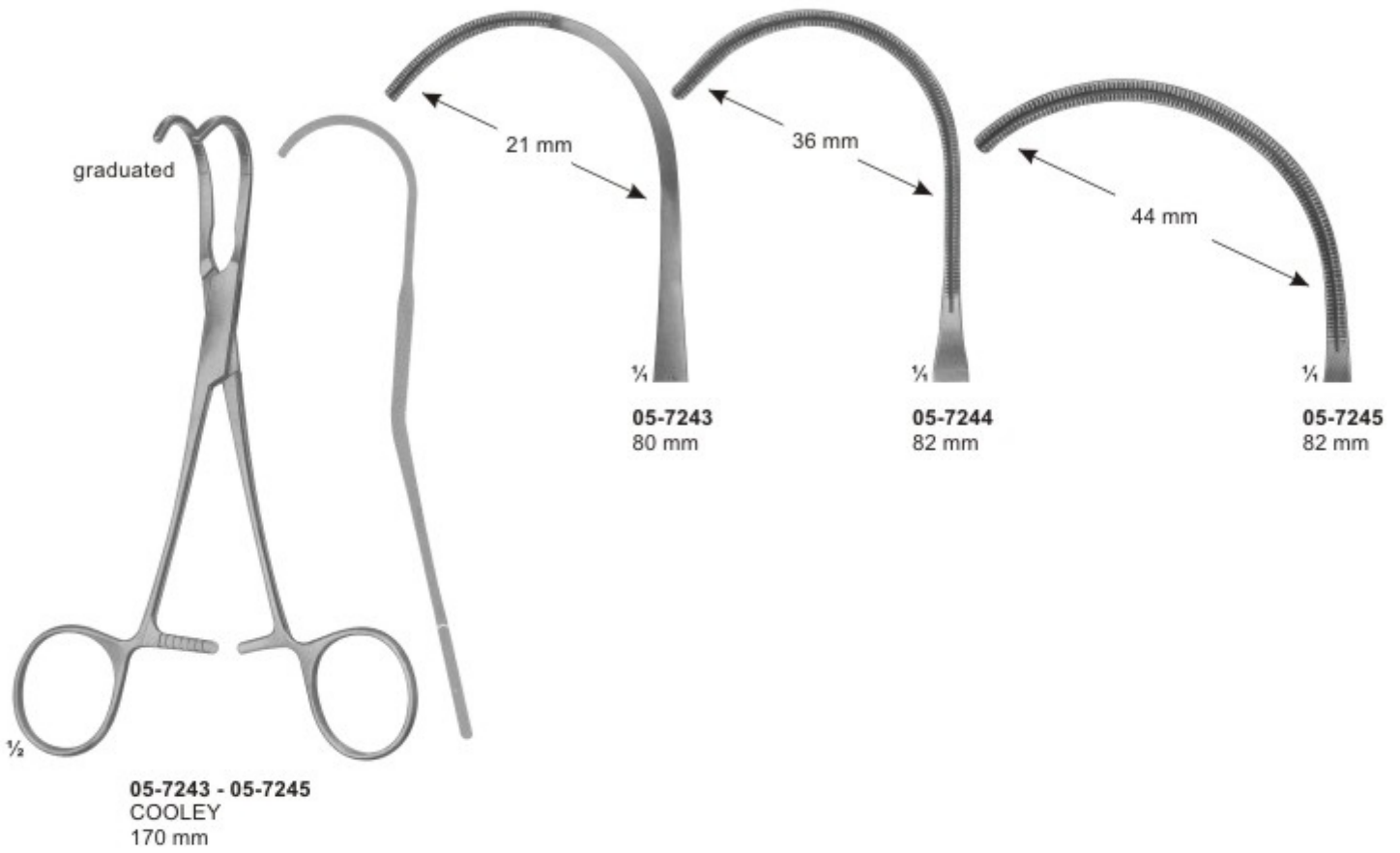

Anastomosis Clamps Multi-Purpose Clamps Pediatric Types

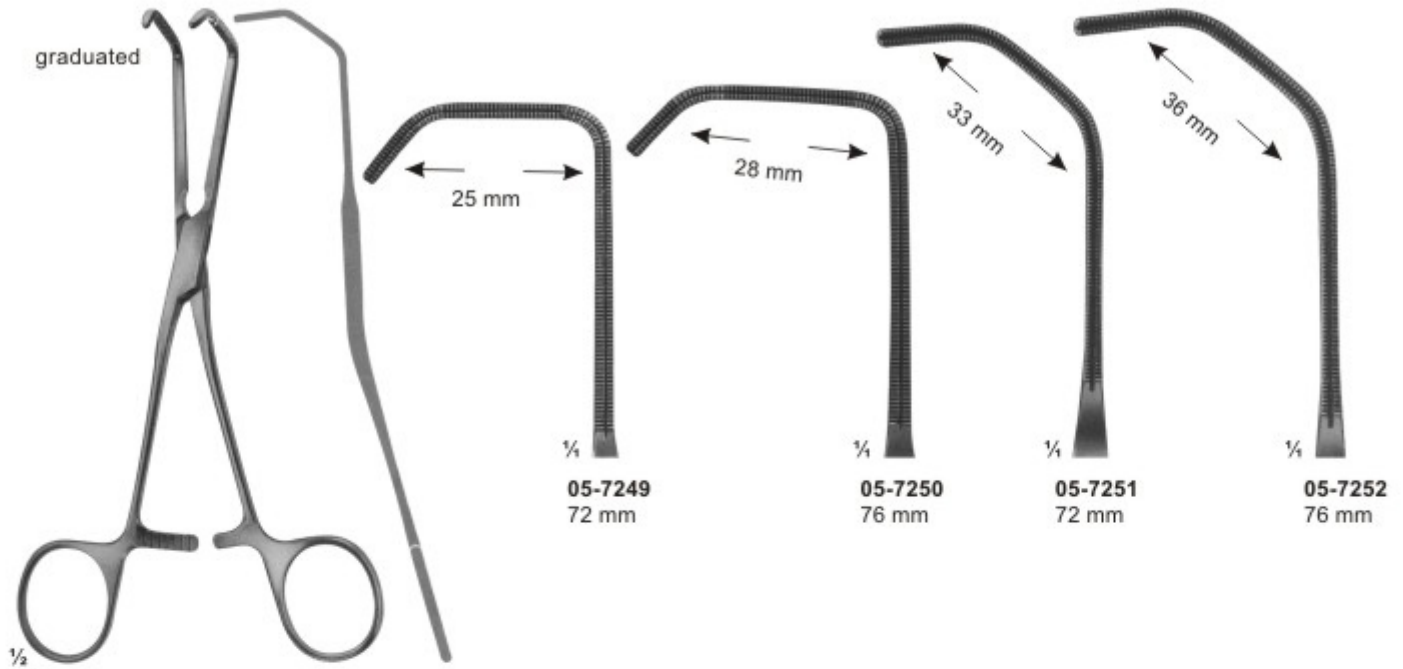

05-7249 - 05-7252
COOLEY
05-7249 165mm
05-7250 165mm
05-7251 175mm
05-7252 180mm

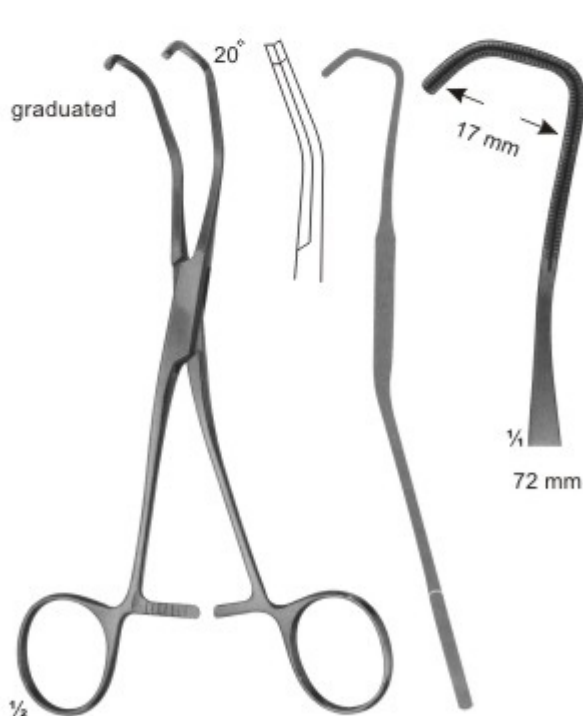

05-7253
COOLEY
170 mm

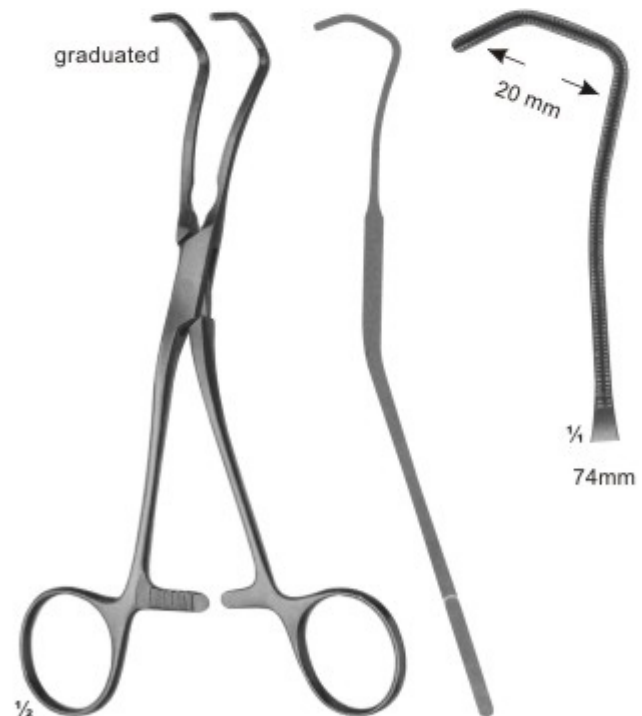

05-7254
COOLEY
175 mm

Multi-Purpose Clamps, Pediatric Types

graduated

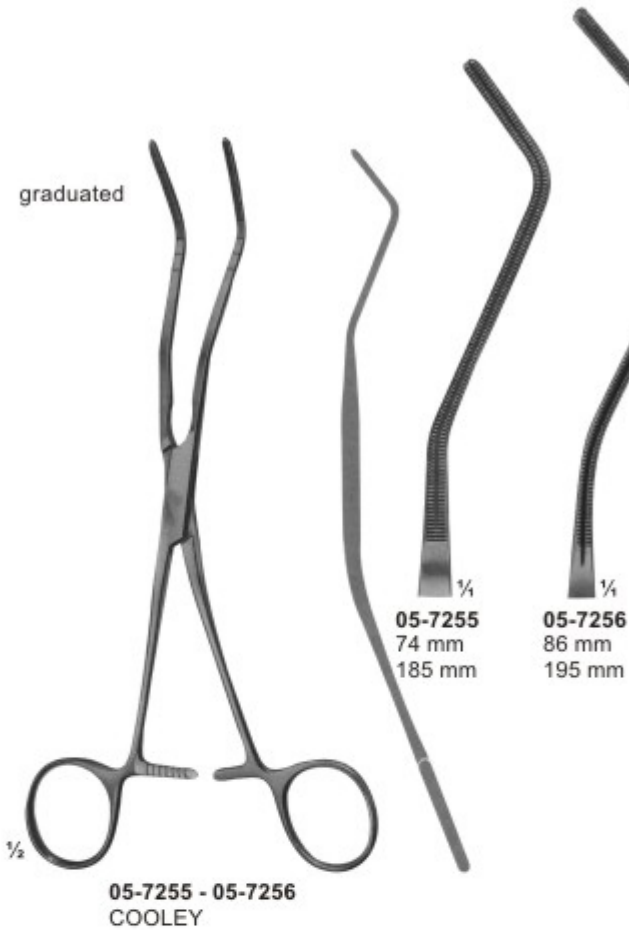

05-7255 - 05-7256
COOLEY

05-7255
74 mm
185 mm

05-7256
86 mm
195 mm

graduated



05-7257
COOLEY
260 mm

graduated

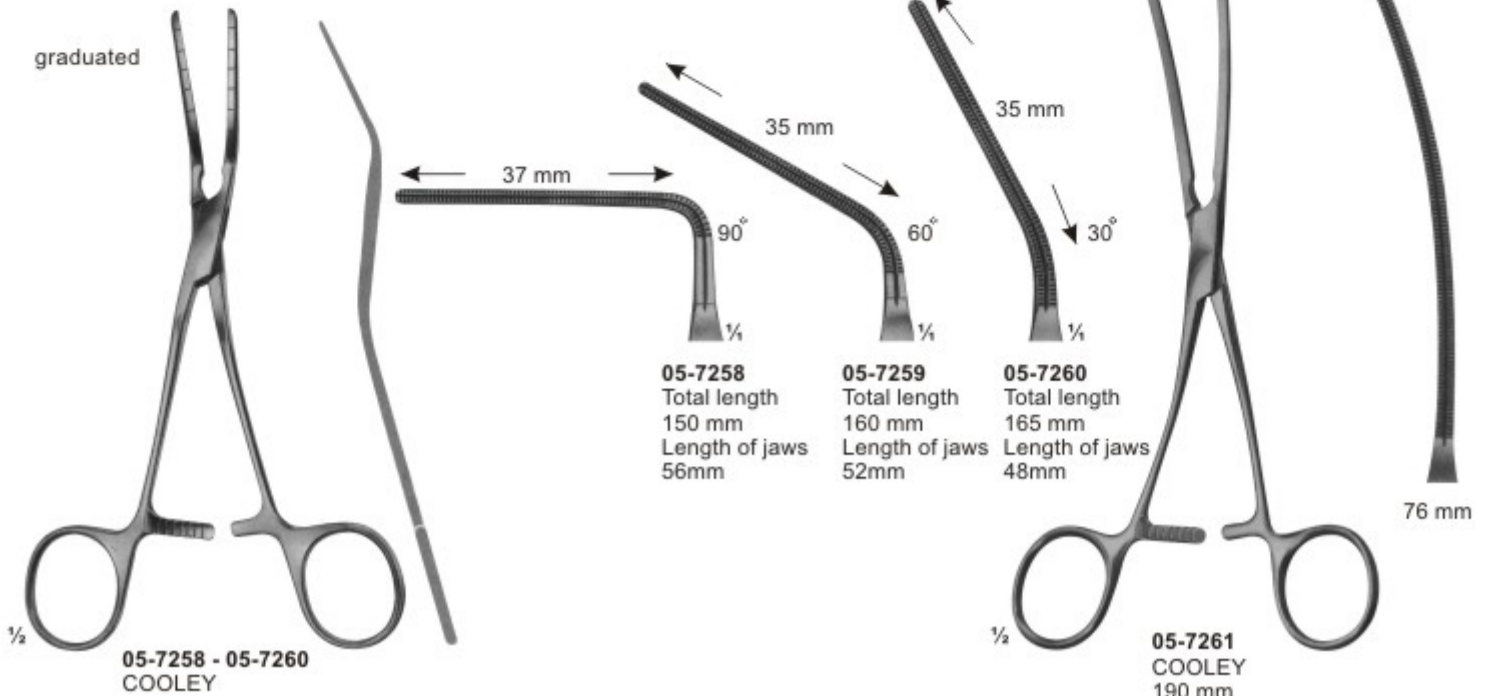

05-7258 - 05-7260
COOLEY

05-7258
Total length
150 mm
Length of jaws
56mm

05-7259
Total length
160 mm
Length of jaws
52mm

05-7260
Total length
165 mm
Length of jaws
48mm

05-7261
COOLEY
190 mm

76 mm

Atraumata Aorta Clamps, Patent-Ductus Clamps, Coarctation Clamps Pediatric Types

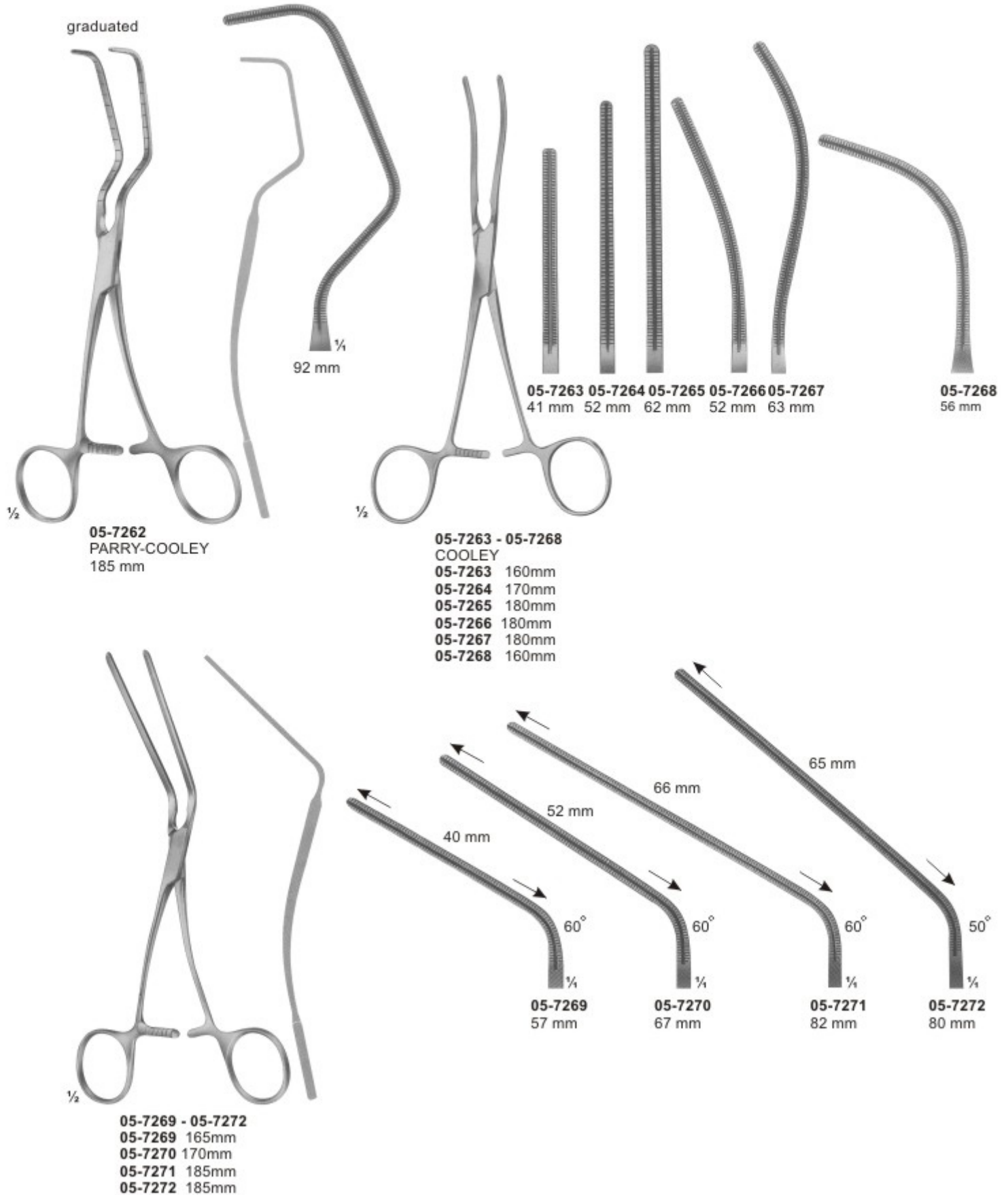

Multi-Purpose Clamps



05-7273 - 05-7282
DARDIK

05-7273	150 mm	05-7278	170 mm
05-7274	150 mm	05-7279	170 mm
05-7275	150 mm	05-7280	170 mm
05-7276	145 mm	05-7281	160 mm
05-7277	130 mm	05-7282	135 mm

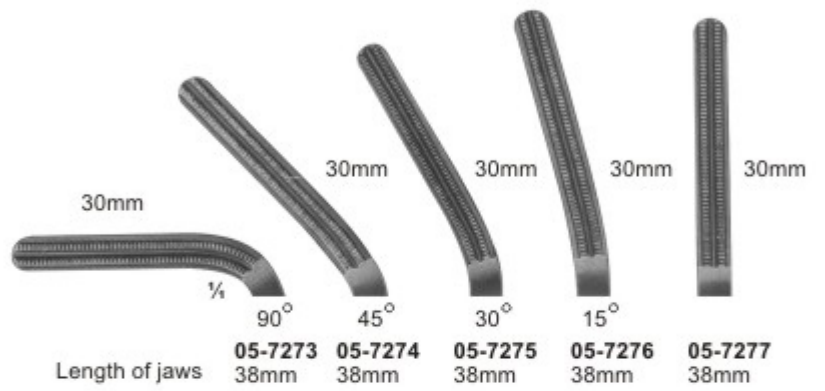

Length of jaws	05-7273 38mm	05-7274 38mm	05-7275 38mm	05-7276 38mm	05-7277 38mm
----------------	------------------------	------------------------	------------------------	------------------------	------------------------

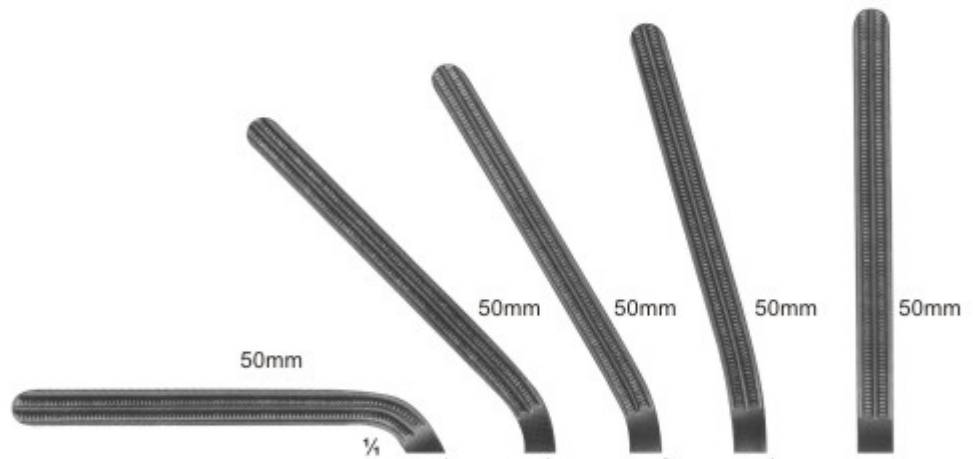

Length of jaws	05-7278 58mm	05-7279 58mm	05-7280 58mm	05-7281 58mm	05-7282 58mm
----------------	------------------------	------------------------	------------------------	------------------------	------------------------

Lung Grasping Forceps



05-7283
WILLIAMS
160 mm



05-7284
TUTTLE
230 mm



05-7285
NELSON
230 mm

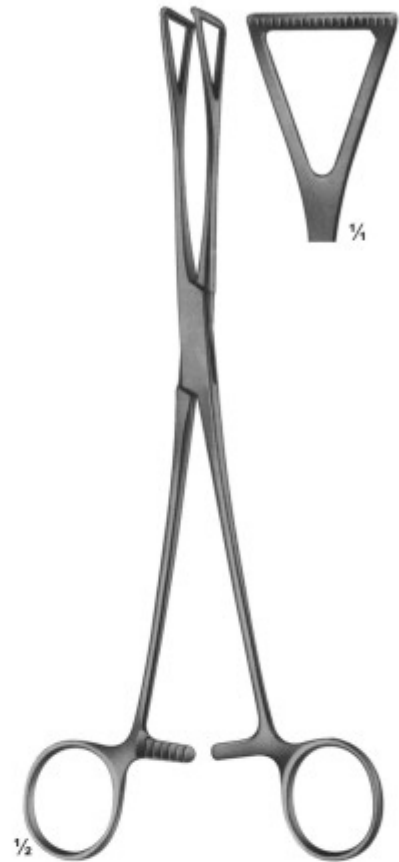

05-7286
DUVAL
230 mm



05-7287 - 05-7289
BABCOCK
05-7287 170 mm
05-7288 215 mm
05-7289 220 mm

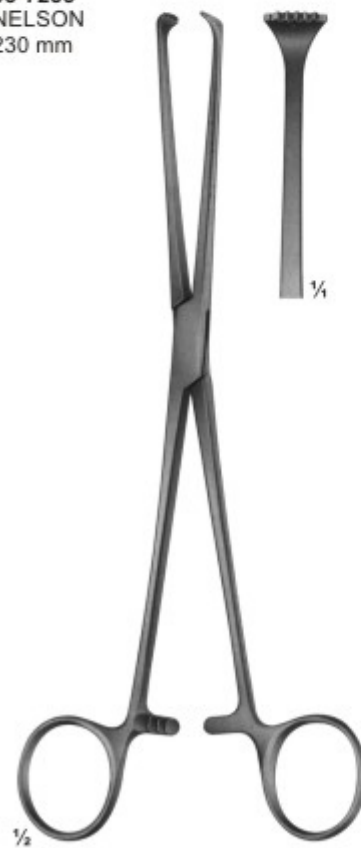

05-7290
ALLIS
220 mm

Dissecting And Ligature Forceps



05-7291
FINOCHIETTO
245 mm



05-7292 - 05-7293
SEMB
240 mm

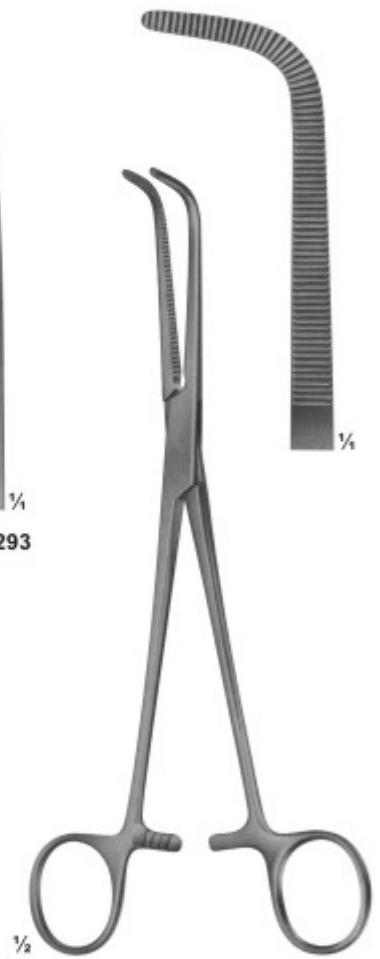

05-7294
WIKSTROEM
205 mm

Dissecting And Ligature Forceps, Vessel Clamps

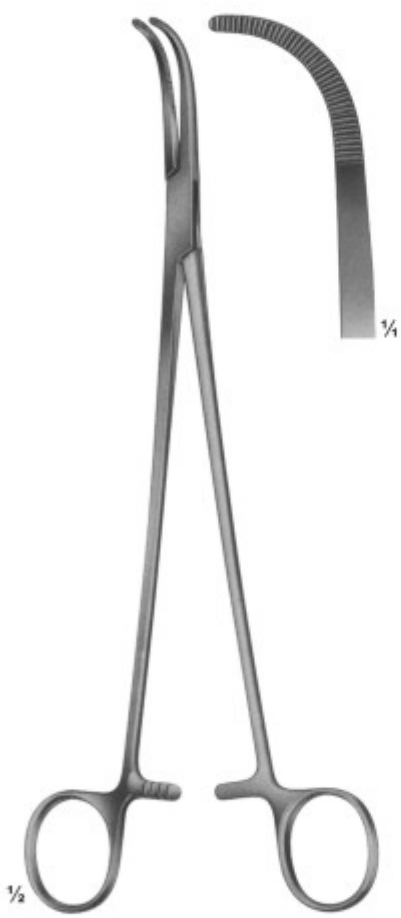

05-7295
MIXTER
230 mm



05-7296 - 05-7297
MIXTER

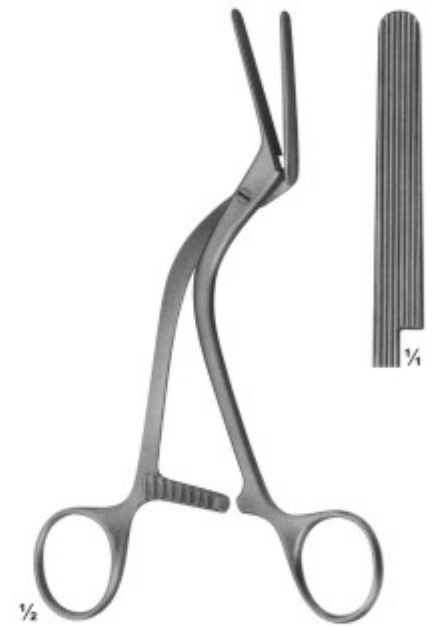

05-7298
HOEPFNER
Vessel clamp
160 mm

Vena Cava Clamps



05-7299
SATINSKY
Anastomosis clamps
265 mm

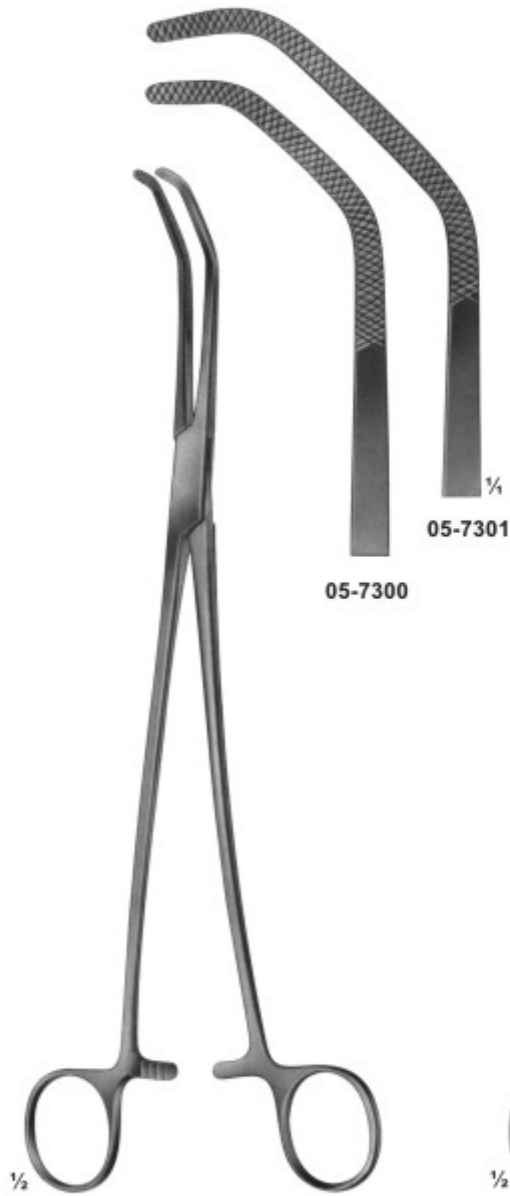

05-7300 - 05-7301
SATINSKY
Anastomosis clamps
265 mm



05-7302
HARKEN
240 mm

Carotid Clamps, Auricle Clamps



05-7303
PERTUISET
Carotid Clamp
90 mm

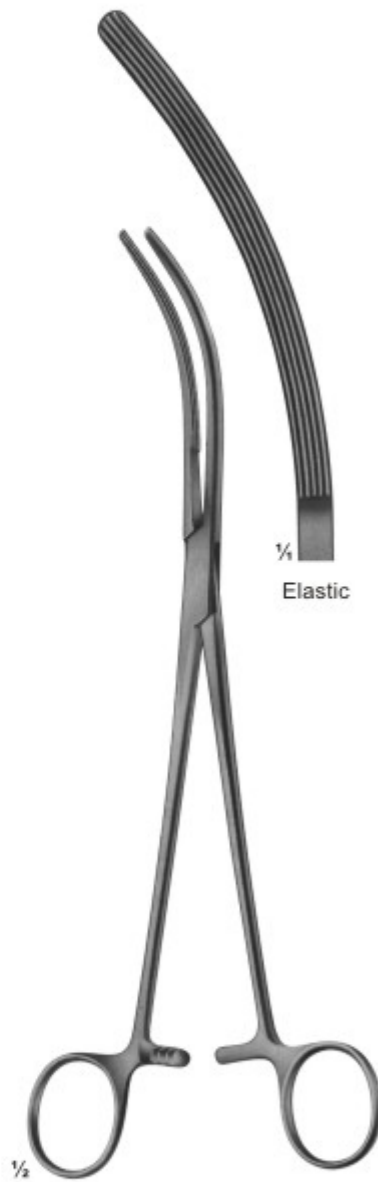

05-7304
CRAFOORD-SELLORS
240 mm

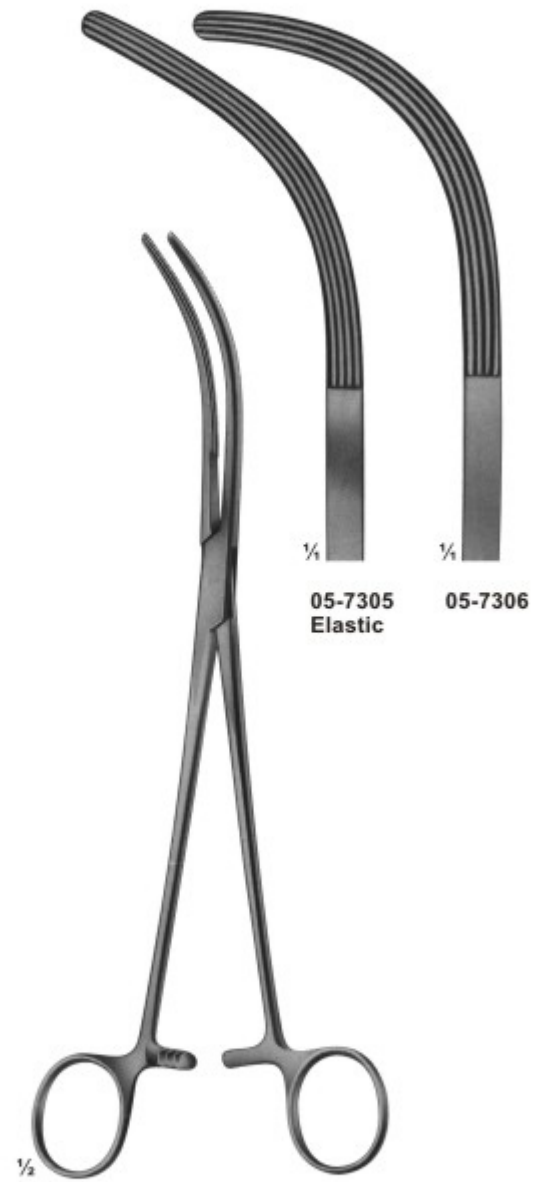

05-7305 - 05-7306
CRAFOORD
240 mm

Bronchus Forceps



05-7307
PRICE THOMAS
225 mm



05-7308
jaws with pins

05-7309
jaws with pins

05-7308 - 05-7309
PRICE THOMAS
225 mm

Sternum Instruments And Rib Shears



05-7310
SCHUMACHER
Sternum shears
210 mm



05-7311
LEBSCHKE
Sternum chisel
200 mm



05-7312
230 mm



05-7313
COLLIN
195 mm



05-7314
GLUCK
190 mm



05-7315
BETHUNE
340 mm



05-7316
BRUNNER
Universal Pattern
340 mm



05-7317
GIERTZ-STILLE
250 mm

Rib Holding Forceps, Bone Cutting Forceps, Rib Rongeurs



05-7318
SEM
Rib-and Bone
Holding forceps
190 mm



05-7319
SEM
Rib-and Bone
Holding forceps
190 mm



05-7320
LISTON-STILLE
265 mm

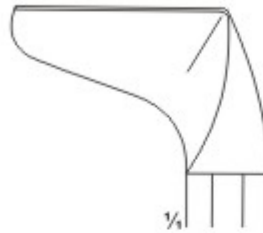

05-7321
LISTON-KEY-HORSLEY
(Tudor Edwards)
255 mm



S-shaped for posterior
rib ends.

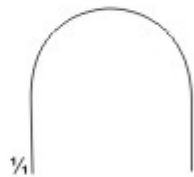

05-7323



05-7324



05-7322
SEM
Rib Rongeur to shorten
the rib stumps
240 mm



05-7323 - 05-7324
SAUERBRUCH-CORYLLOS
Rib rongeurs to shorten
the rib stumps
310 mm

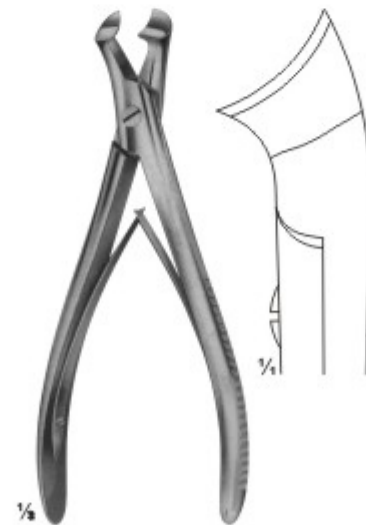

05-7325
MARKWALDER
Rib Rongeur to Round
the rib stumps
190 mm



Rib Raspatories



05-7326



05-7327



05-7326 - 05-7327
DOYEN
for children
175 mm



05-7328



05-7329



05-7328 - 05-7329
DOYEN
for adults
175 mm



05-7330



05-7331



05-7330 - 05-7331
DOYEN
240 mm

Rib Raspatories



1/2
05-7332 -05-7336
SEMB
230 mm



12 mm
05-7332
190 mm



12 mm
05-7333
230mm



13 mm
05-7334
230mm



13 mm
05-7335
230mm



15 mm
05-7336
230mm

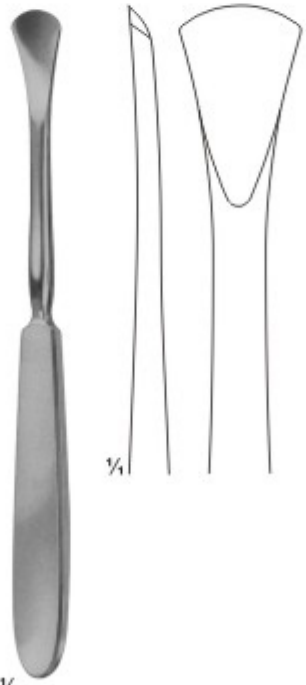

1/2
05-7337
LANGENBECK
190 mm



1/2
05-7338 - 05-7342
LAMBOTTE
215 mm

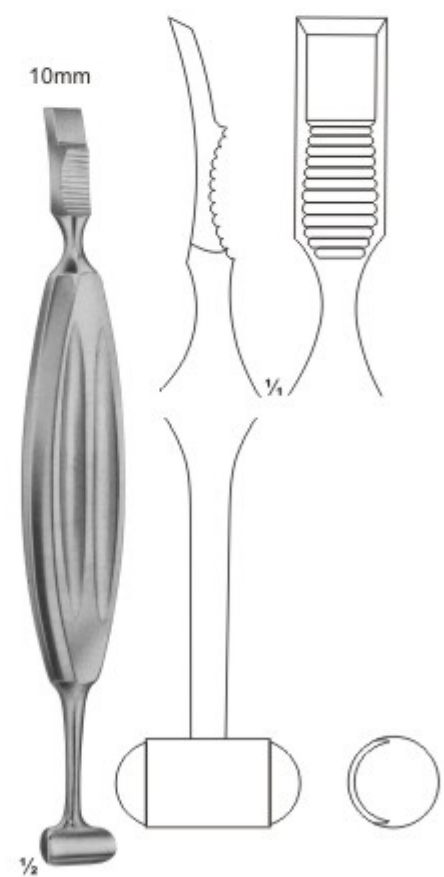

10mm
1/4
05-7343
ALEXANDER
210 mm

Rib Spreaders



05-7344
FINOCHIETTO
Blades
18X21 mm

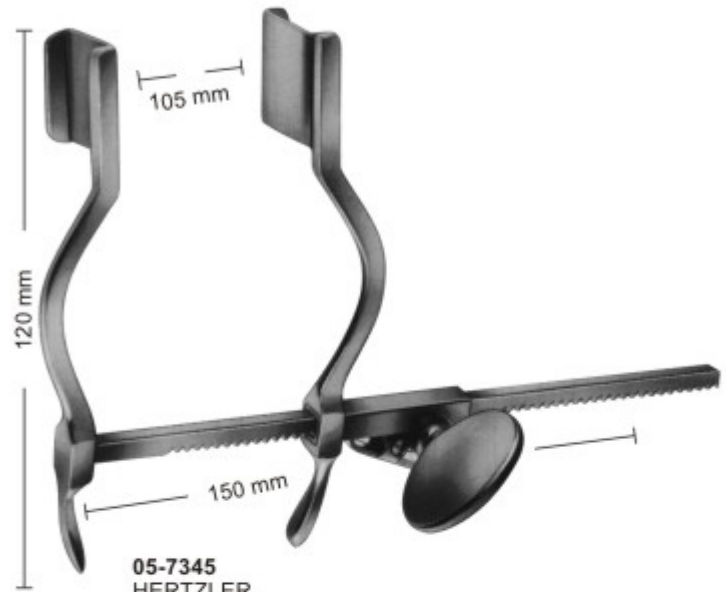

05-7345
HERTZLER
Blades
20X25 mm

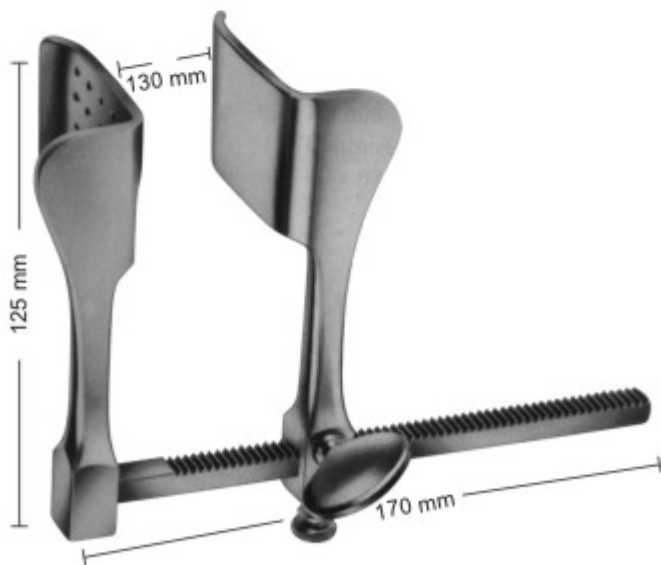

05-7346
TUFFIER
Blades
43X53 mm

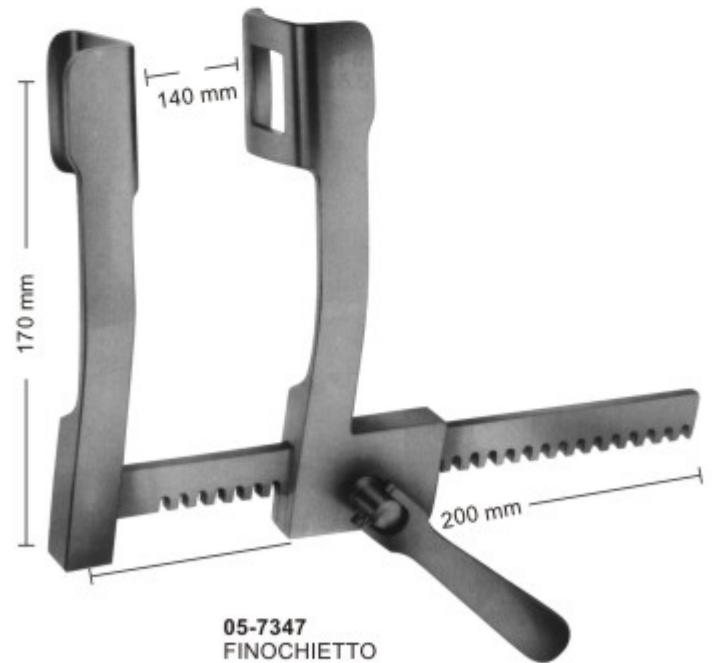

05-7347
FINOCHIETTO
Blades
36X45 mm

Rib Spreaders

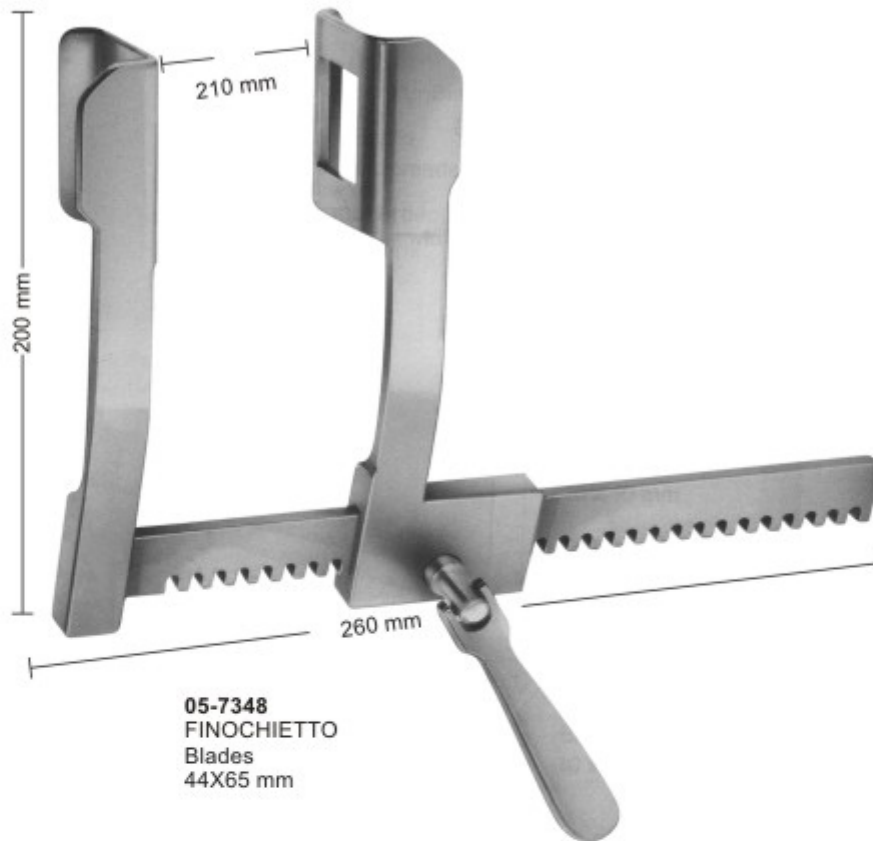

05-7348
FINOCHIETTO
Blades
44X65 mm

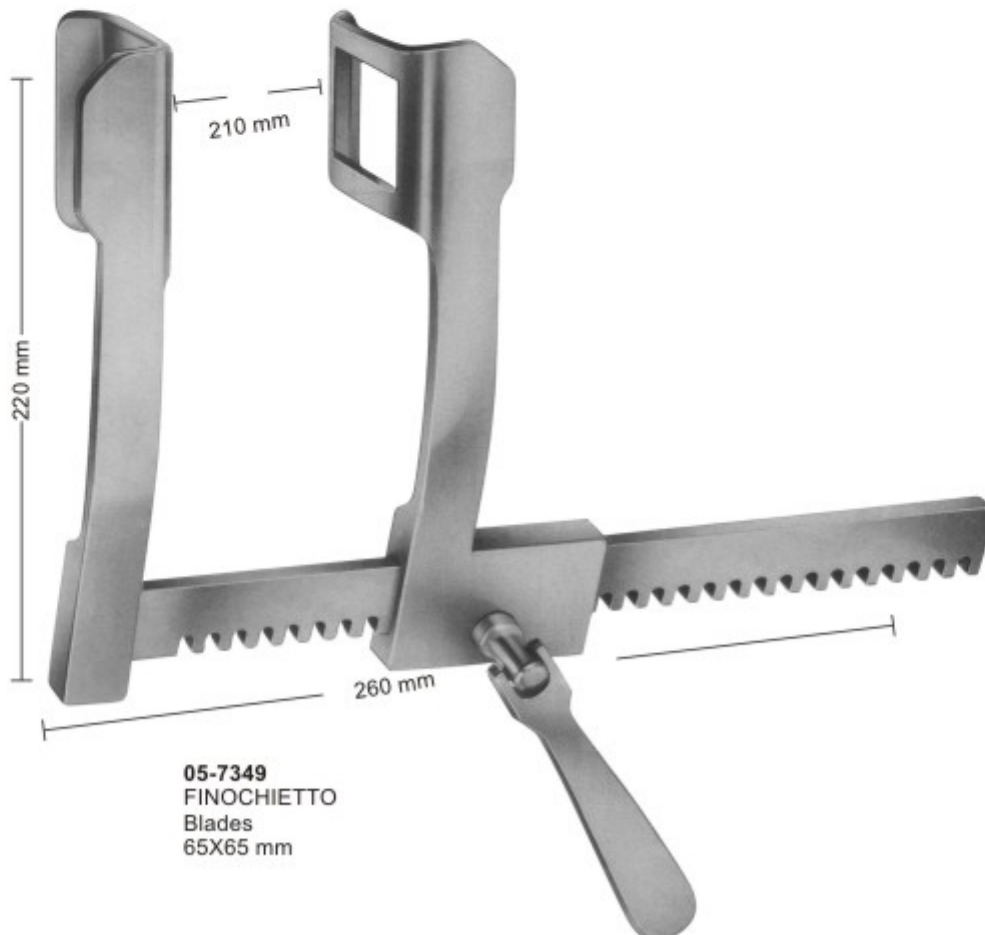

05-7349
FINOCHIETTO
Blades
65X65 mm

Rib Spreaders

05-7351
Blades
30x80 mm



05-7352
Blades
40x67 mm



05-7353
Blades
80x67 mm



220 mm

220 mm

05-7354
Blade, Only, for preparation
of a. Mammaria, 25.5x80mm

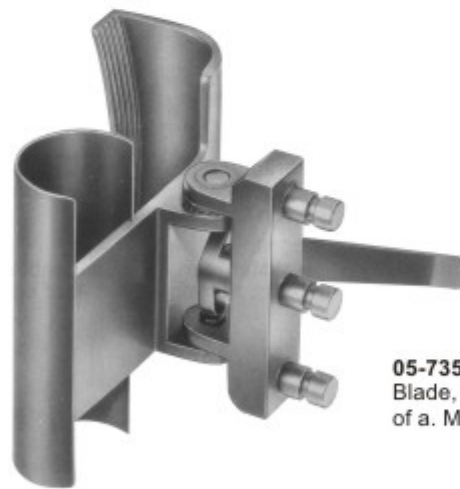

300 mm

05-7350
FINOCHIETTO-BURFORD
with 2 pairs of blades
(05-7352 - 05-7353)

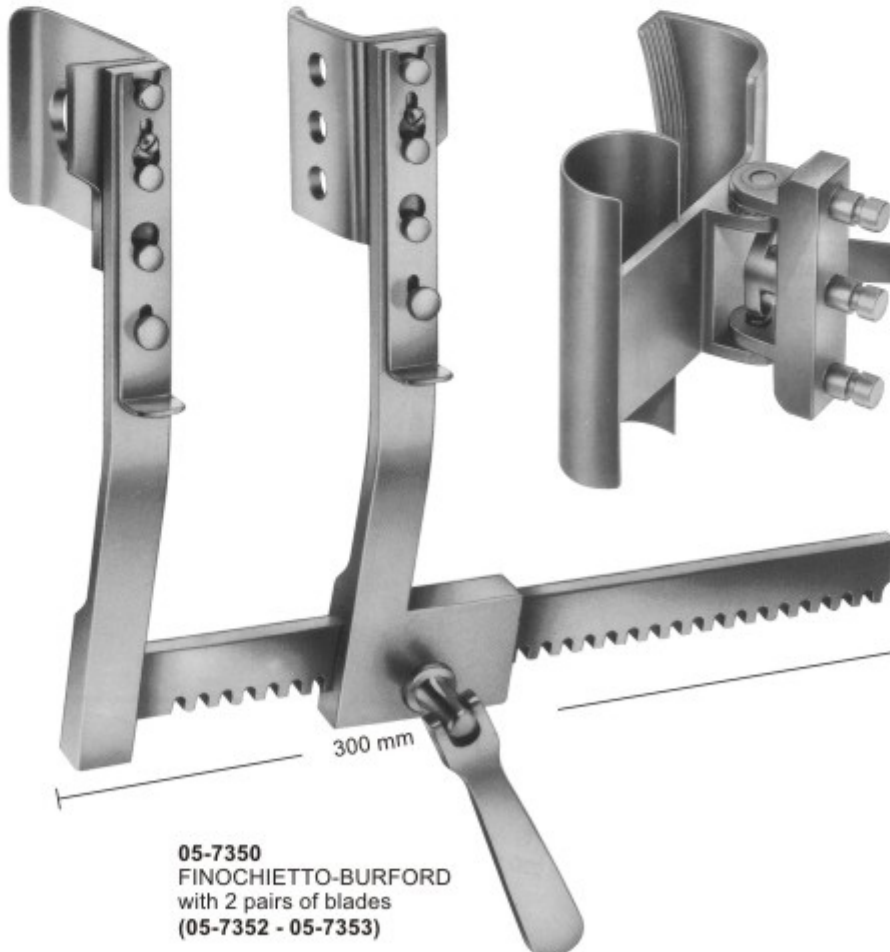

Rib Spreaders

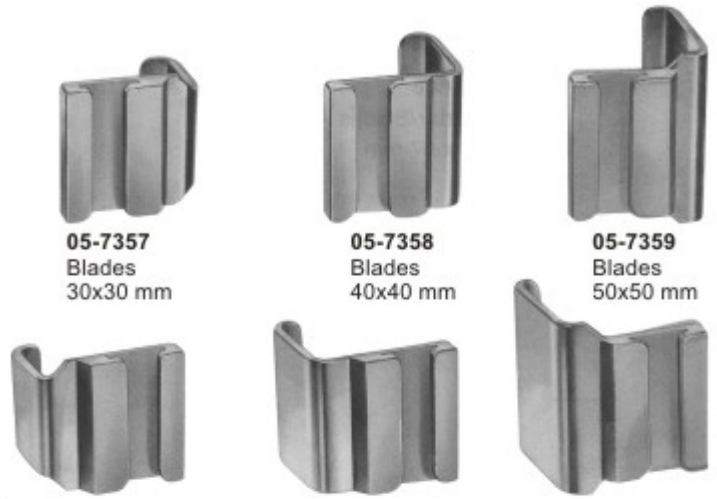
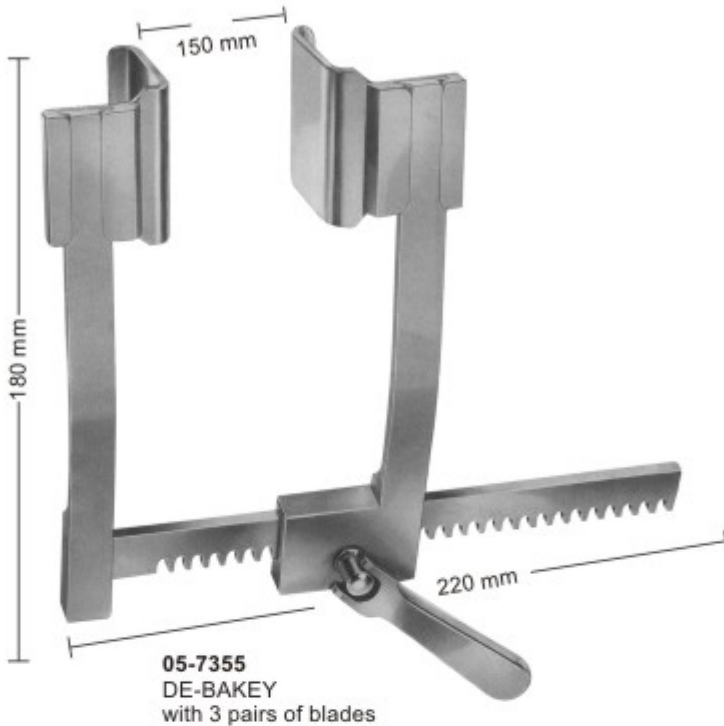

Components for **05-7355**
Spreader only Blades only
05-7357 30x30mm
05-7358 40x40mm
05-7359 50x50mm
The Blades are delivered in Pairs.

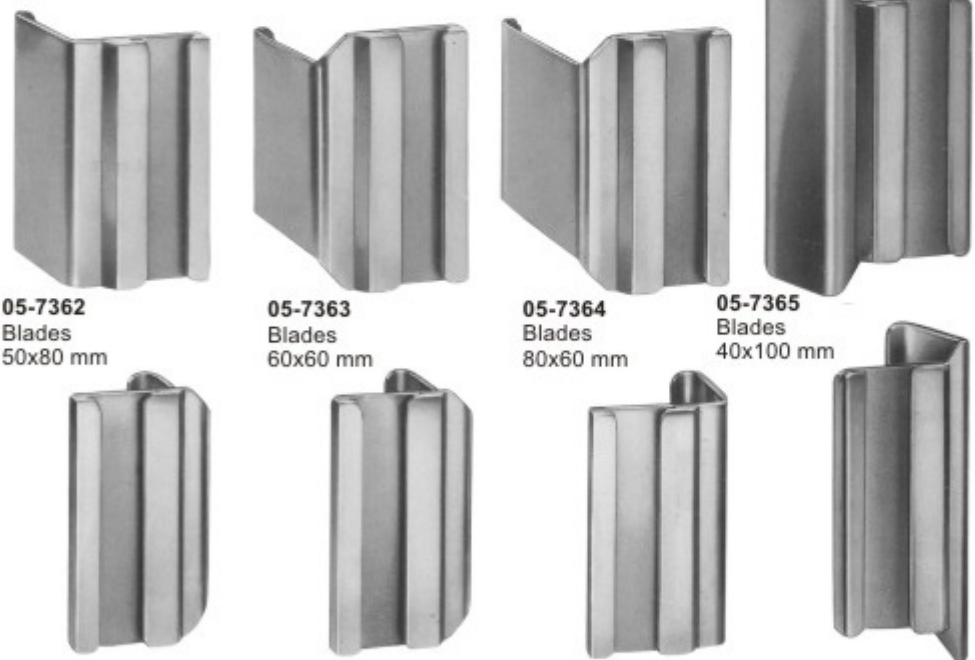
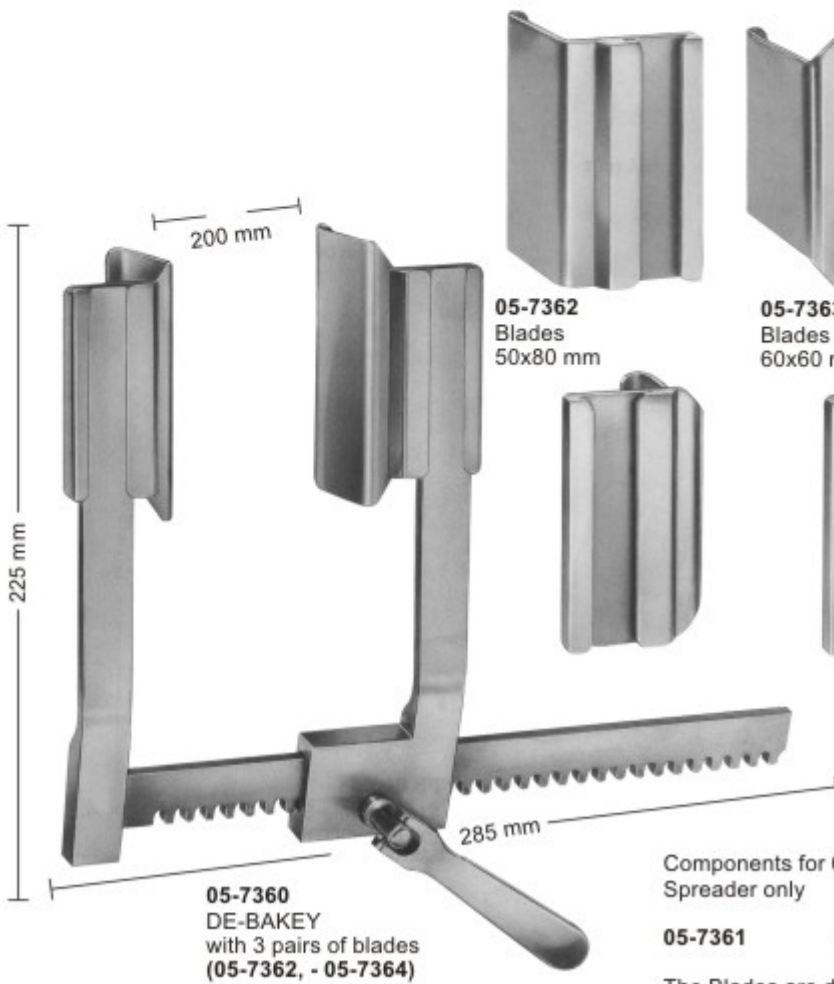

Components for **05-7360**
Spreader only Blades only
05-7362 50x80mm
05-7363 60x60mm
05-7364 40x100mm
The Blades are delivered in Pairs.

05-7366
Sternotomy Blades (50x66 mm)

Sternotomy Spreaders

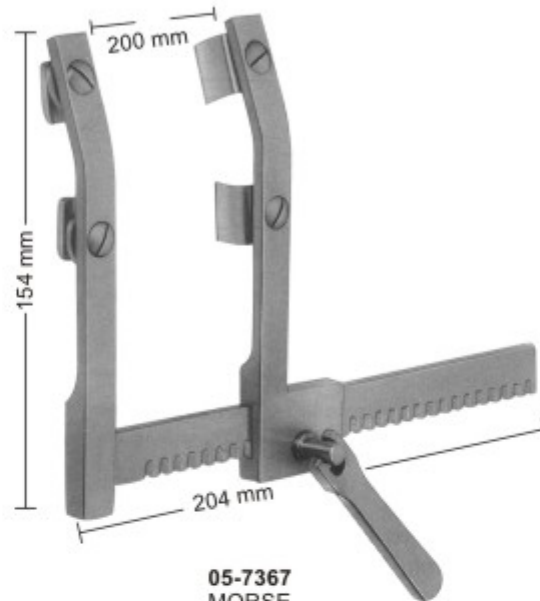

05-7367
MORSE
Sternotomy spreader
for children, with moveable
double, blades each blade
12x20 mm

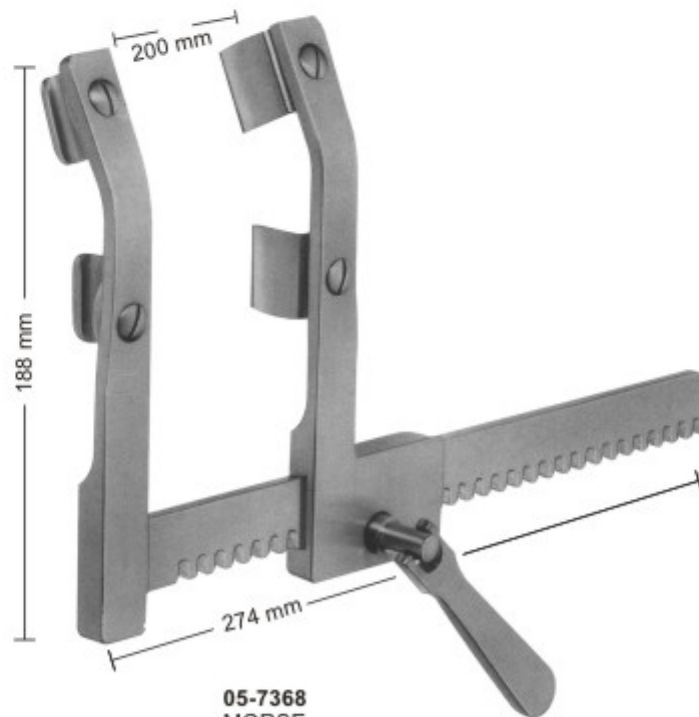

05-7368
MORSE
Sternotomy spreader
for adults, with moveable
double, blades each blade
19x19 mm

Sternotomy- Spreaders

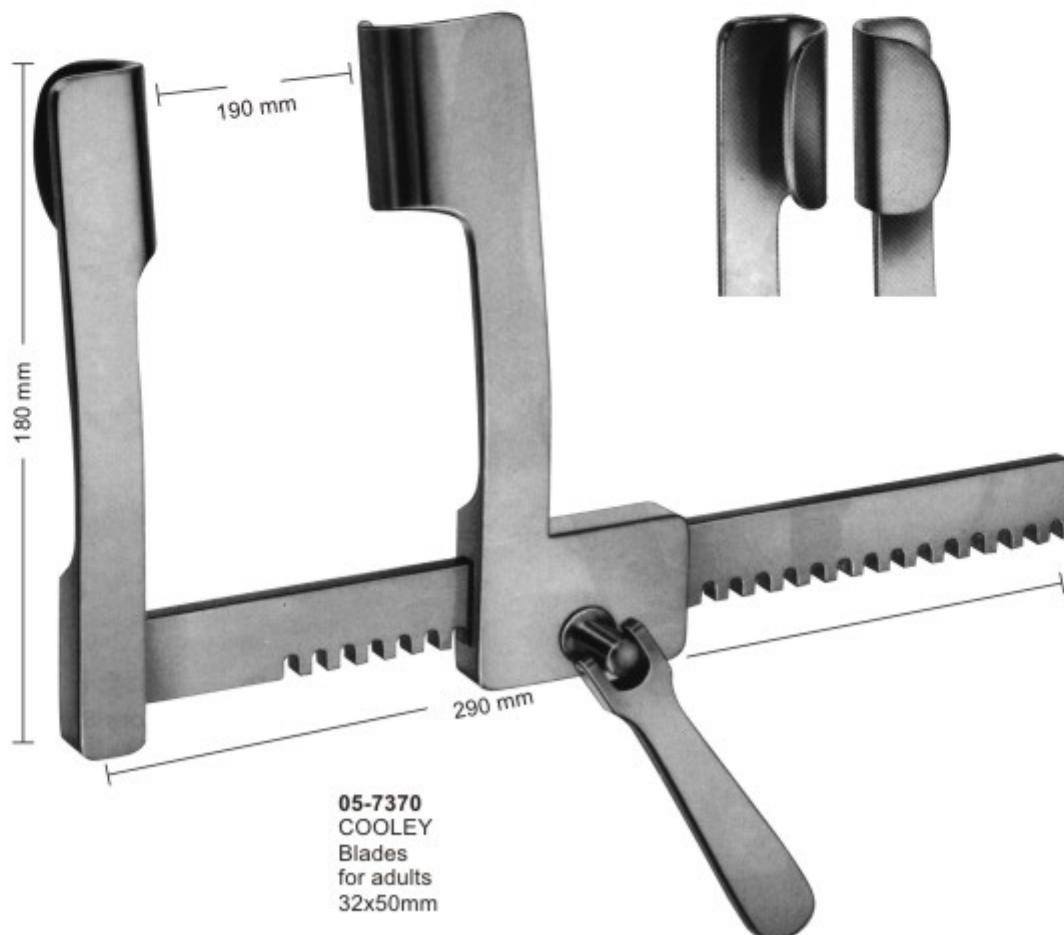
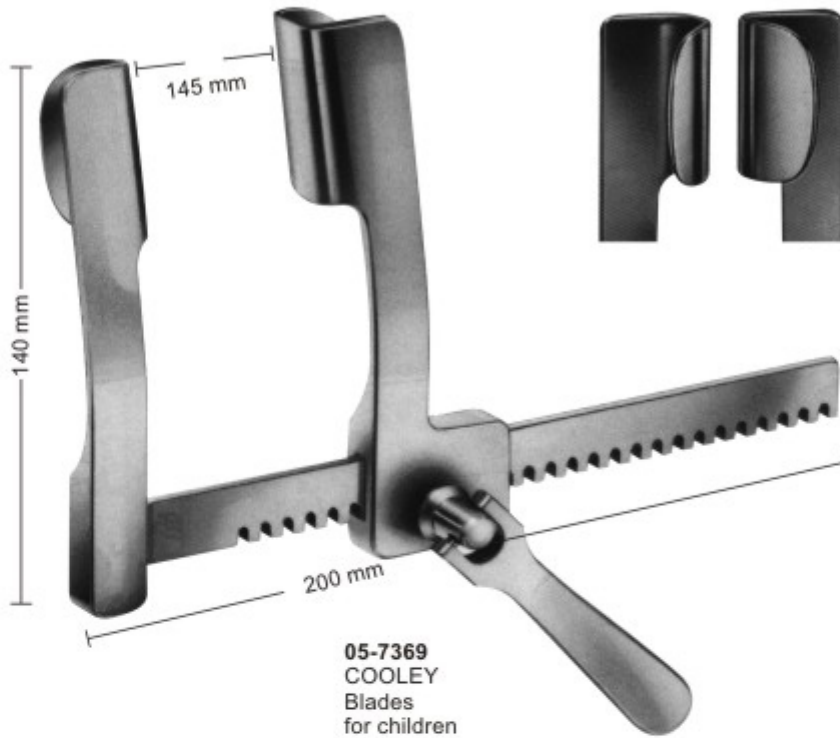

Thoracic Retractors



05-7371
Blades
75x75 mm



05-7373
Blades
42x65 mm

Blades with Ball Snap System
Delivery: in Pairs

- 05-7371 - 05-7373**
Thoracic Retractor (Mercedes-Retractor)
complete consisting of:
05-7371 Retractor only
05-7372 1 Pair of blades 75x75 mm
05-7373 1 Pair of blades 42x65 mm

Rib Spreaders-and Contractors



05-7374
SELLORS
Rib spreader-and contractor
with swivel blades
200 mm



05-7375
BAILEY
150 mm



05-7376
for children

05-7377
for adults

05-7376 - 05-7377
BAILEY
200 mm

Retractors, Lung Spatulas

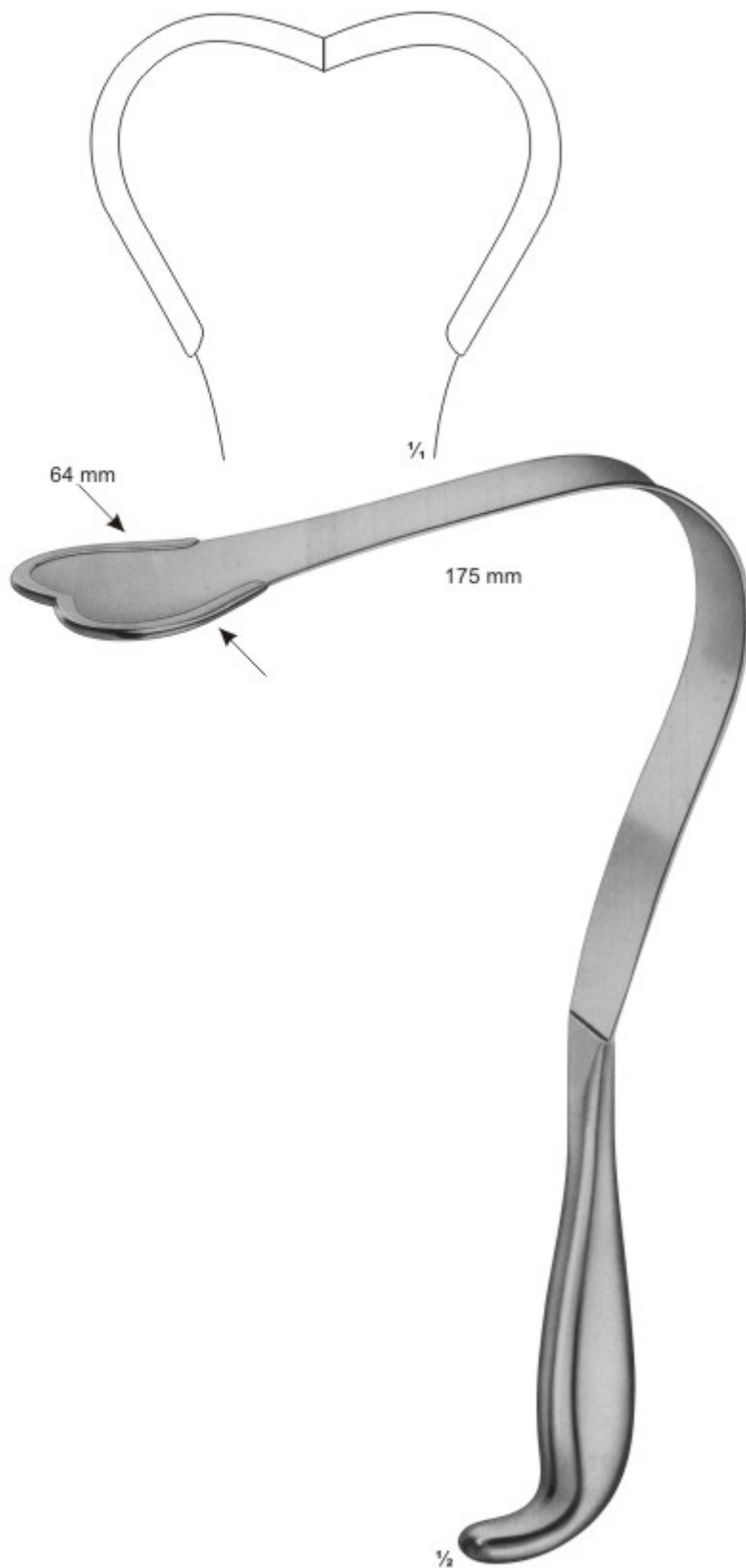

05-7378
HARRINGTON-PEMBERTON
flexible
295 mm

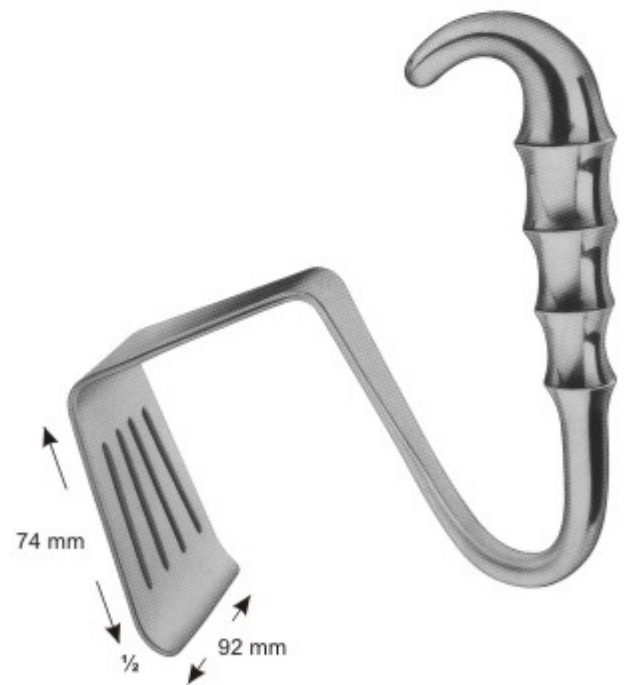

05-7379
DAVIDSON
Scapula retractor

Lung Spatulas, Suction Cannulae

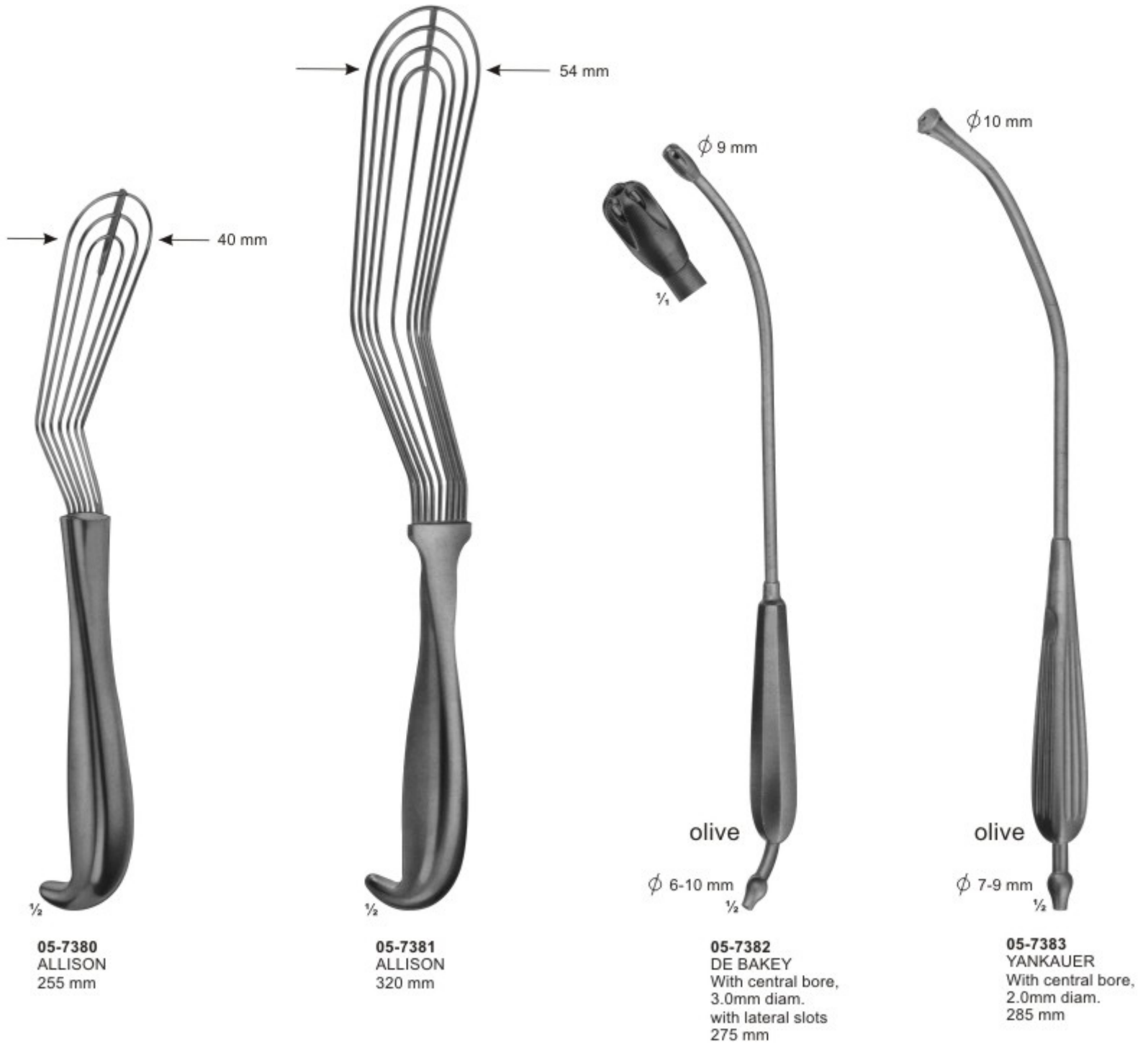

Punches

Angled positions for punchus

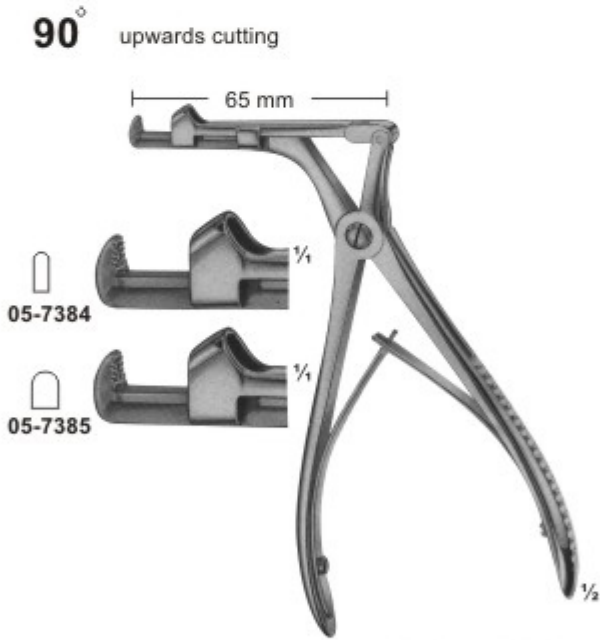
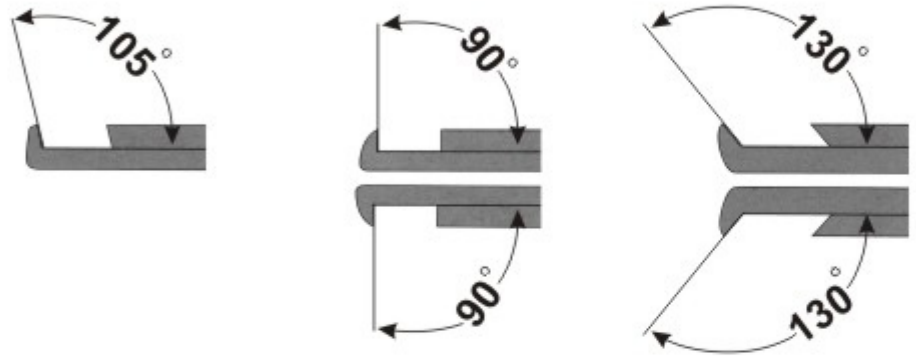

05-7384 - 05-7385
CITELLI
05-7384 2mm
05-7385 3.5mm

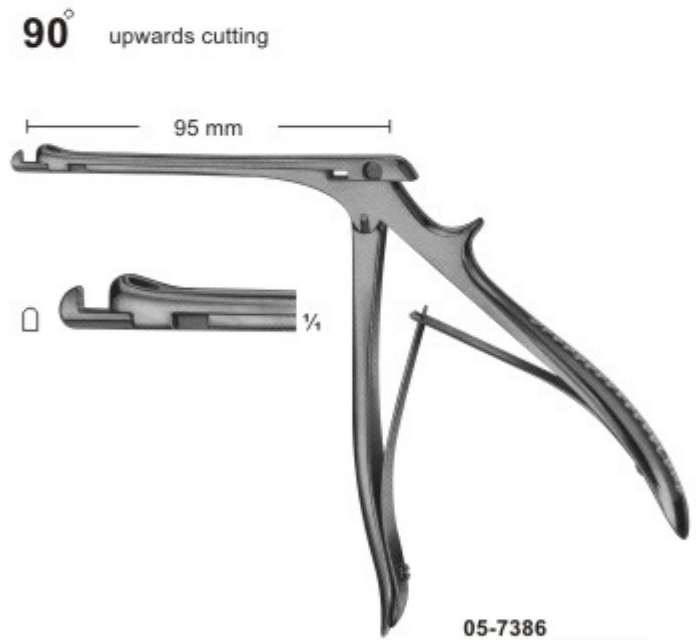

05-7386
CITELLI- BEYER
 1,8 mm

Punches

90° upwards cutting

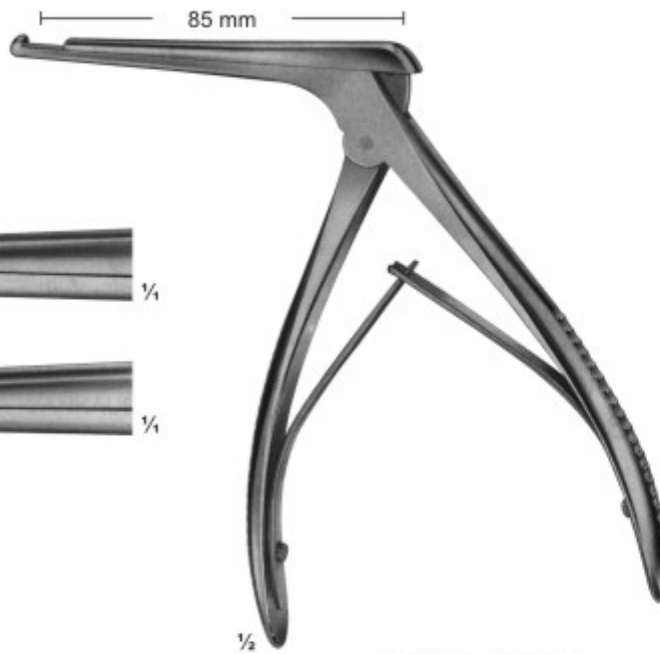

05-7387
4 mm



05-7388
5 mm



05-7387 - 05-7388
KERRISON

90° upwards cutting

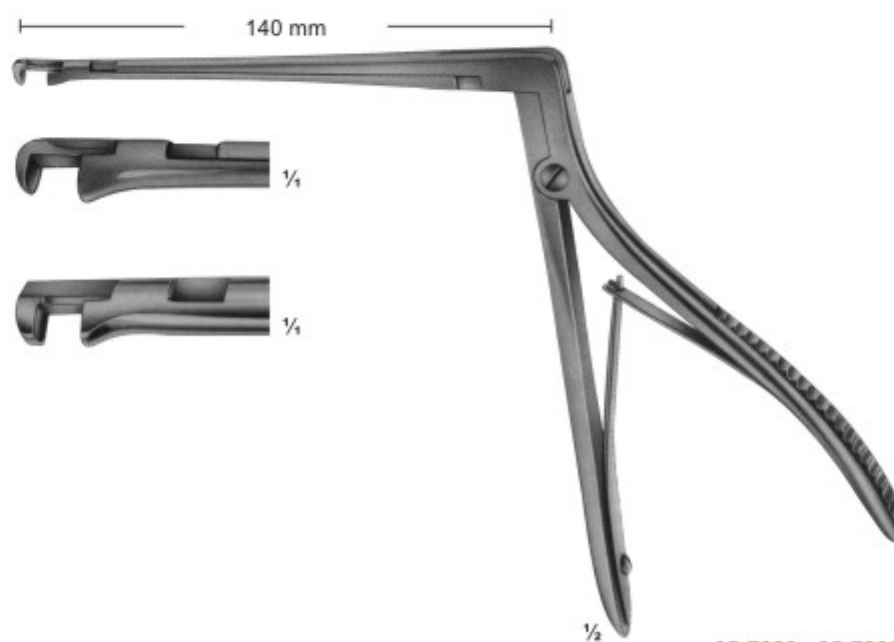

05-7389
3,3 mm



05-7390
4,0 mm



05-7389 - 05-7390
HAJEK-KOFLER

Punches

130° upwards cutting

KERRISON-JACOBY

05-7391
1 mm 

FERRIS-SMITH-KERRISON

05-7392
2 mm 

05-7393
3 mm 

05-7394
4 mm 

05-7395
5 mm 

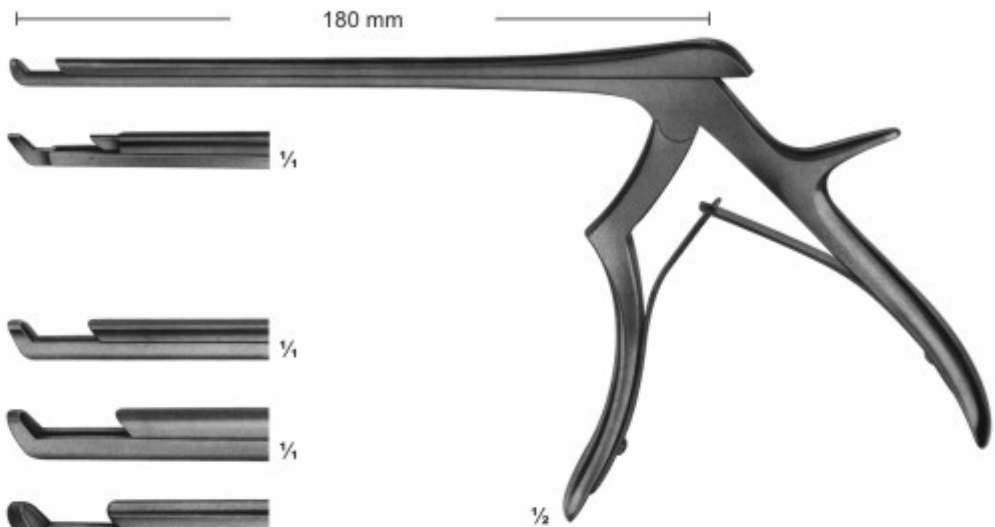

05-7391 - 05-7395

90° upwards cutting

KERRISON-JACOBY

05-7396
1 mm 

05-7397
2 mm 

FERRIS-SMITH-KERRISON

05-7398
3 mm 

05-7399
4 mm 

05-7400
5 mm 

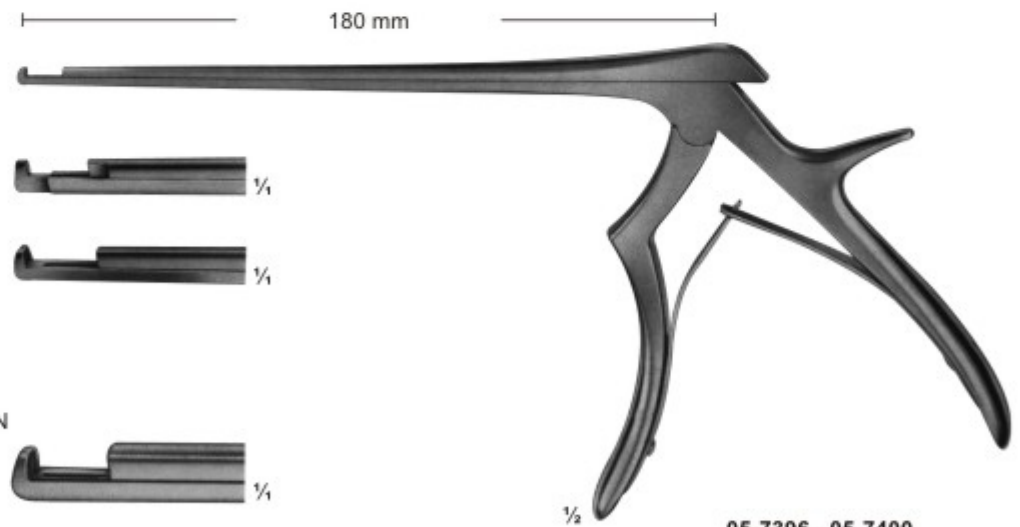

05-7396 - 05-7400

Rongeurs

Angled positions for rongeurs

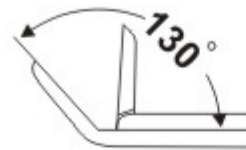
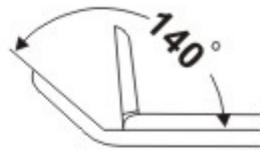
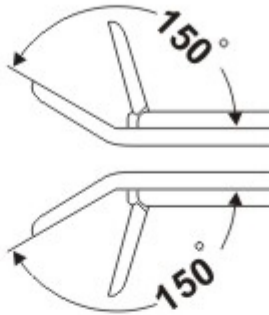

05-7401
3,0 mm

05-7402
3,6 mm

05-7403
4,2 mm

05-7404
4,8 mm

05-7405
5,8 mm

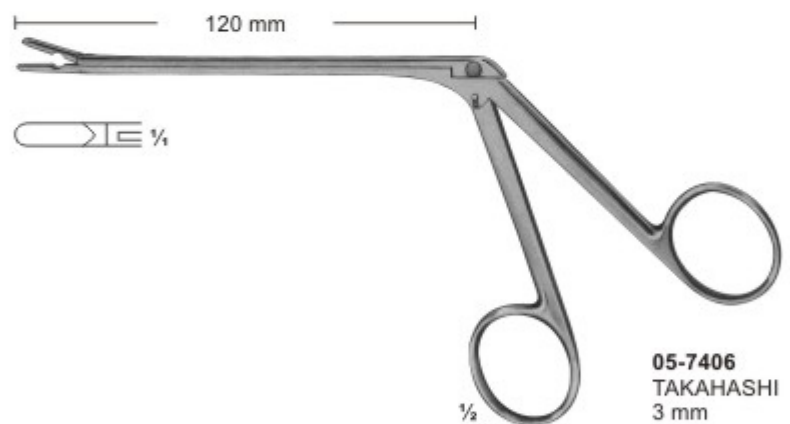
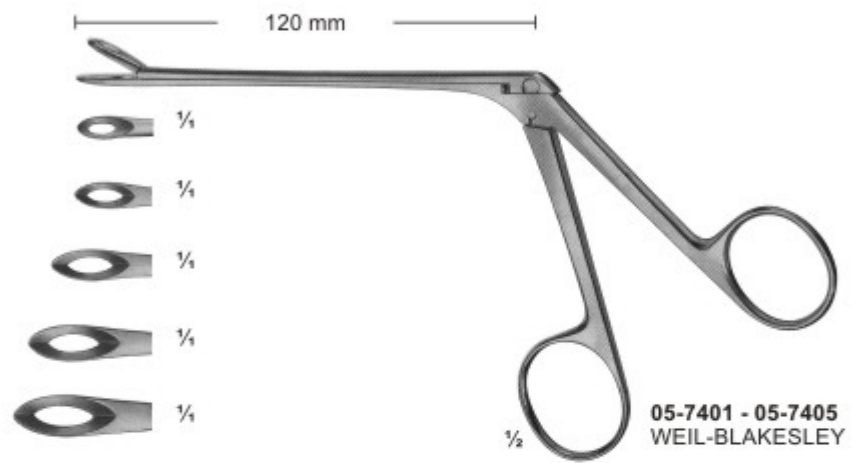

130°

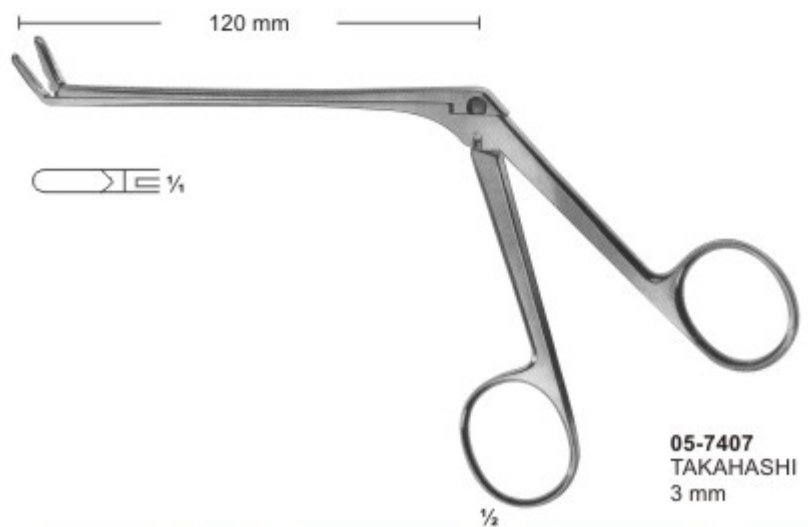

Rongeurs

LOVE-GRUENWALD

05-7408
2 X 10 mm

05-7409
3 X 10 mm

SPURLING

05-7410
4 X 10 mm

130 mm

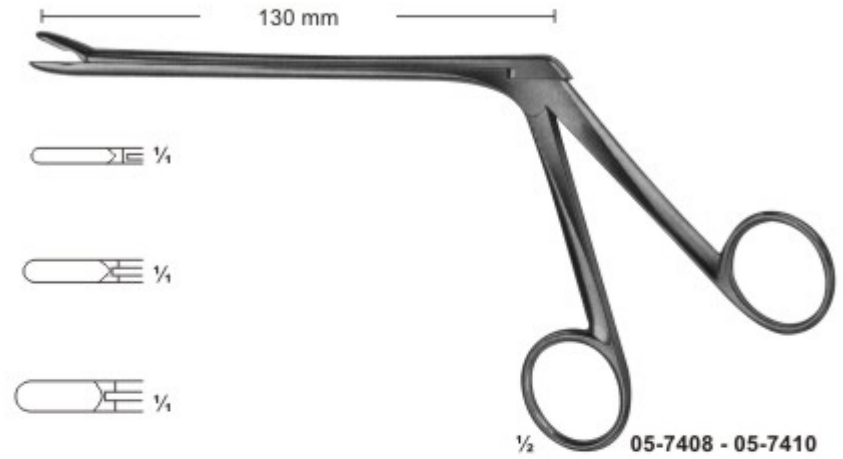

1/2 **05-7408 - 05-7410**

05-7411
2 mm

05-7412
3 mm

05-7413
4 mm

05-7414
5 mm

155 mm

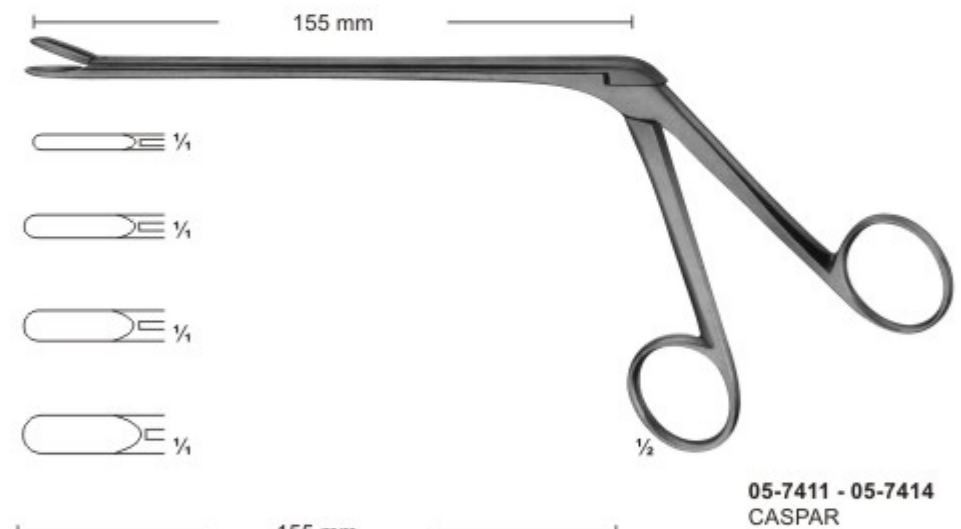

1/2 **05-7411 - 05-7414**
CASPAR

150°

05-7415
2 mm

05-7416
3 mm

05-7417
4 mm

155 mm

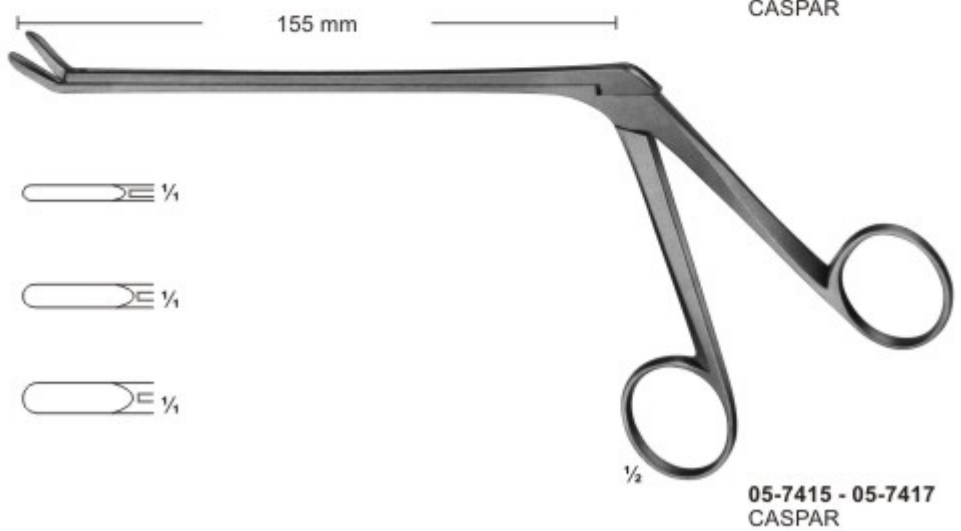

1/2 **05-7415 - 05-7417**
CASPAR

Rongeurs

150°

Lower part of jaws movable

05-7418
2 mm

05-7419
3 mm

05-7420
4 mm

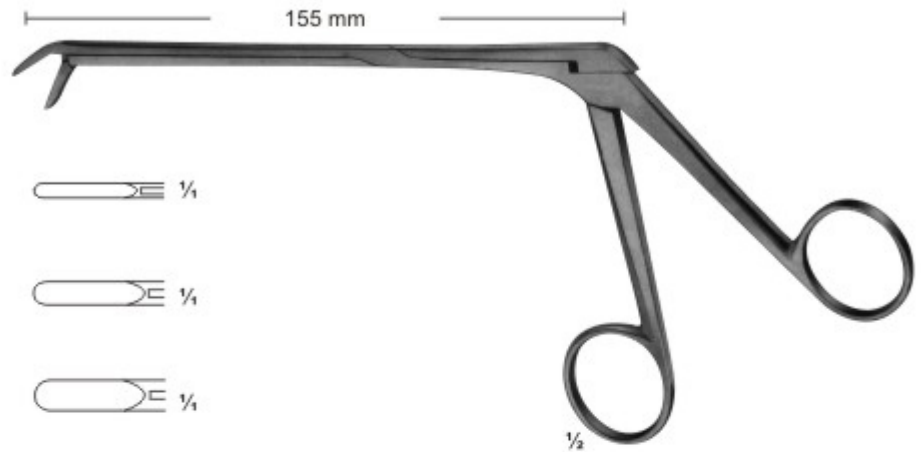

05-7418 - 05-7420
CASPAR

Length of shaft 140 mm	Length of shaft 160 mm	Length of shaft 185 mm	size of jaws
05-7421	05-7426	05-7431	2 X12 mm
05-7422	05-7427	05-7432	3 X12 mm
05-7423	05-7428	05-7433	4 X14 mm
05-7424	05-7429	05-7434	5 X14 mm
05-7425	05-7430	05-7435	6 X16 mm

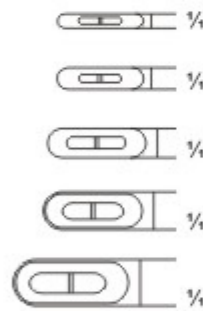

05-7421 - 05-7435
CASPAR

150°

Length of shaft 140 mm	Length of shaft 160 mm	Length of shaft 185 mm	size of jaws
05-7436	05-7439	05-7442	3 X12 mm
05-7437	05-7440	05-7443	4 X14 mm
05-7438	05-7441	05-7444	5 X14 mm



05-7436 - 05-7444
CASPAR

Rongeurs

150°

Lower part of jaw movable

Length of shaft 140 mm	Length of shaft 160 mm	Length of shaft 185 mm	size of jaws
05-7445	05-7447	05-7449	3 X 12 mm
05-7446	05-7448	05-7450	4 X 14 mm

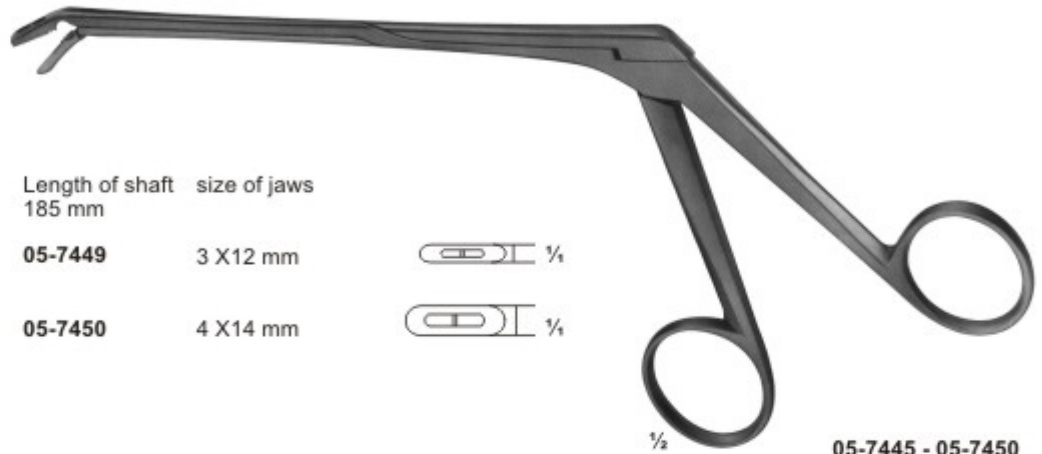

05-7445 - 05-7450
CASPAR

05-7451
2 X 10 mm
CUSHING



05-7452
3 X 10 mm
LOVE-GRUENWALD

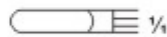

05-7453
4 X 10 mm
SPURLING

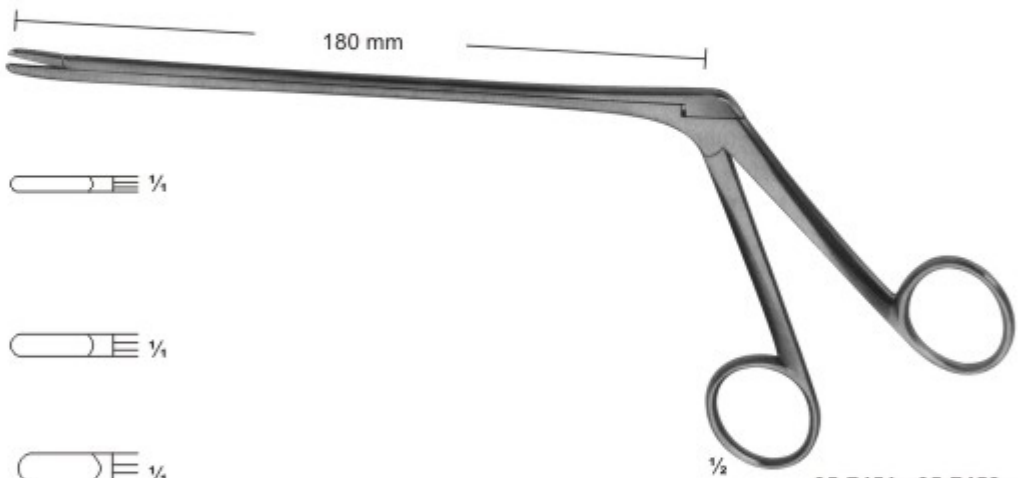

05-7451 - 05-7453

150°

05-7454
3 X 10 mm
LOVE-GRUENWALD

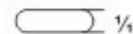

05-7455
4 X 10 mm
SPURLING

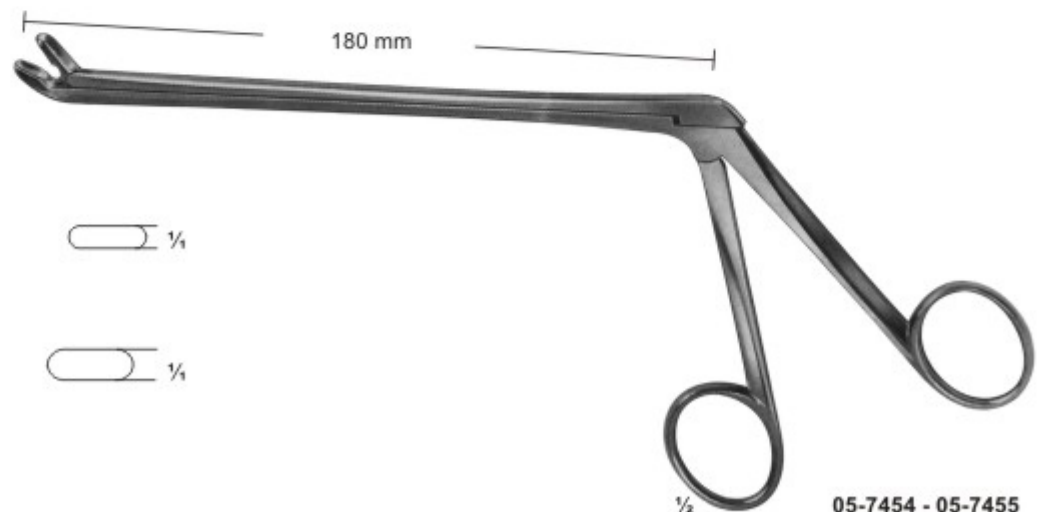

05-7454 - 05-7455

Rongeurs

150°

Upper part of jaw
movable

05-7456
3 X 10 mm
LOVE-GRUENWALD

05-7457
4 X 10 mm
SPURLING

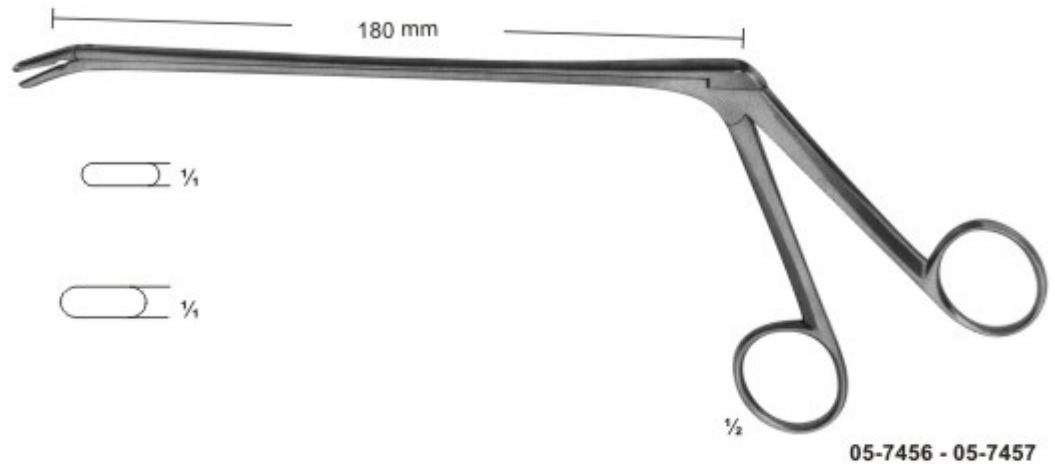

05-7458
Ø 7 mm

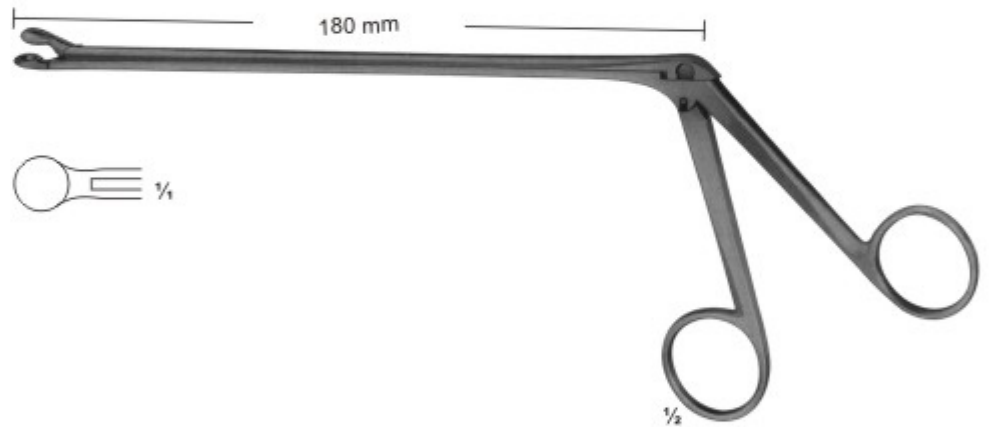

05-7459
YASARGIL
Ø 2,2 mm

05-7460
YASARGIL
Ø 3,5 mm

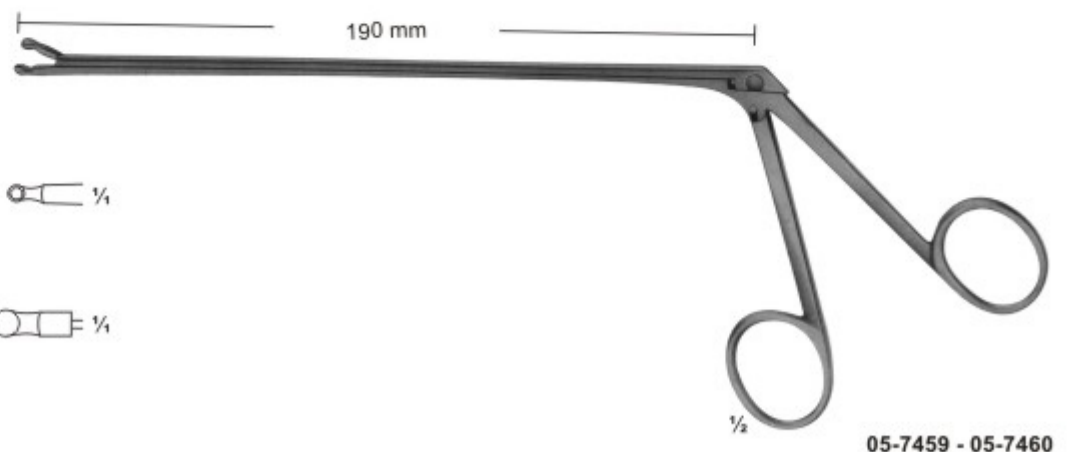

Rongeurs

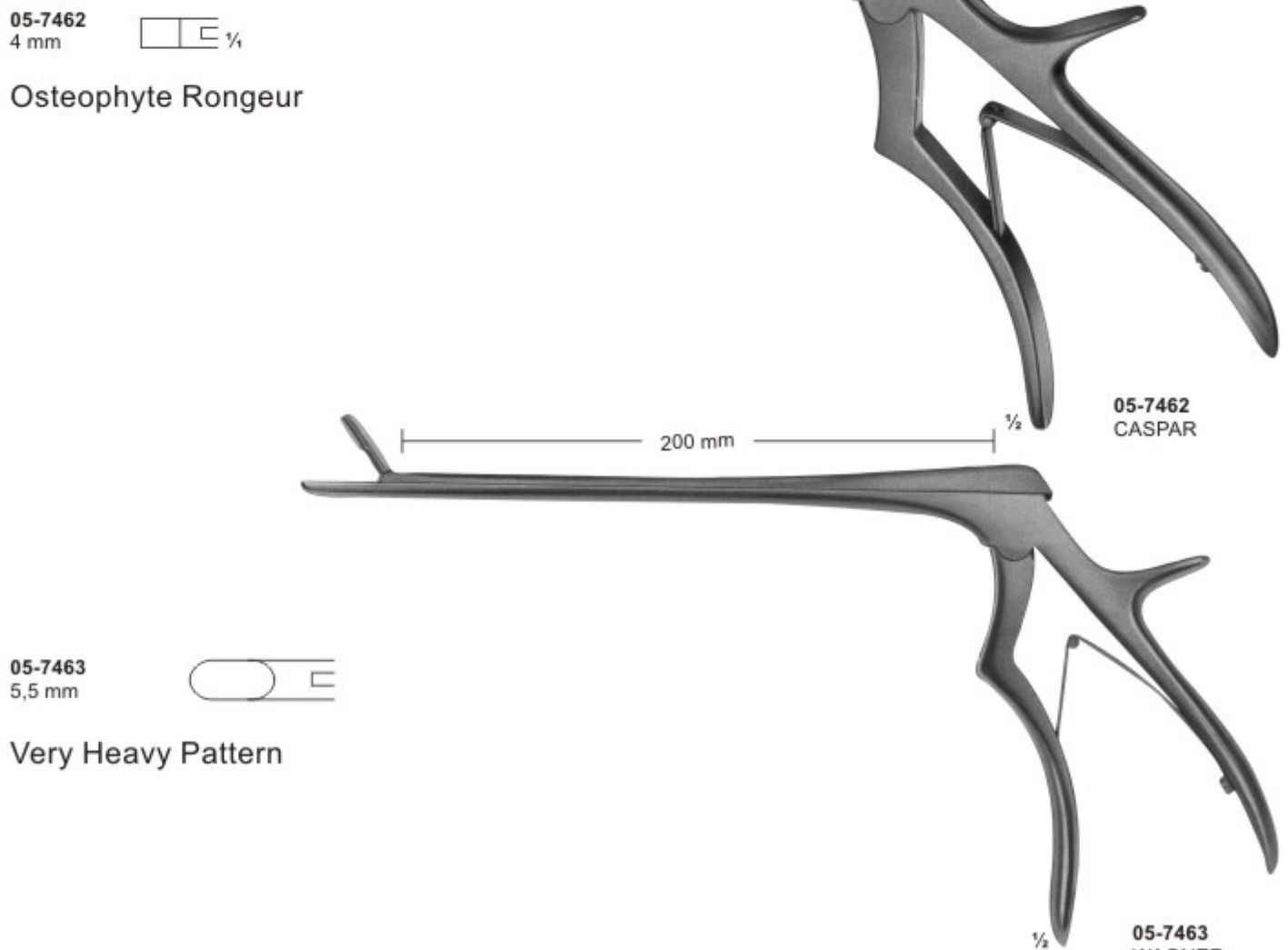
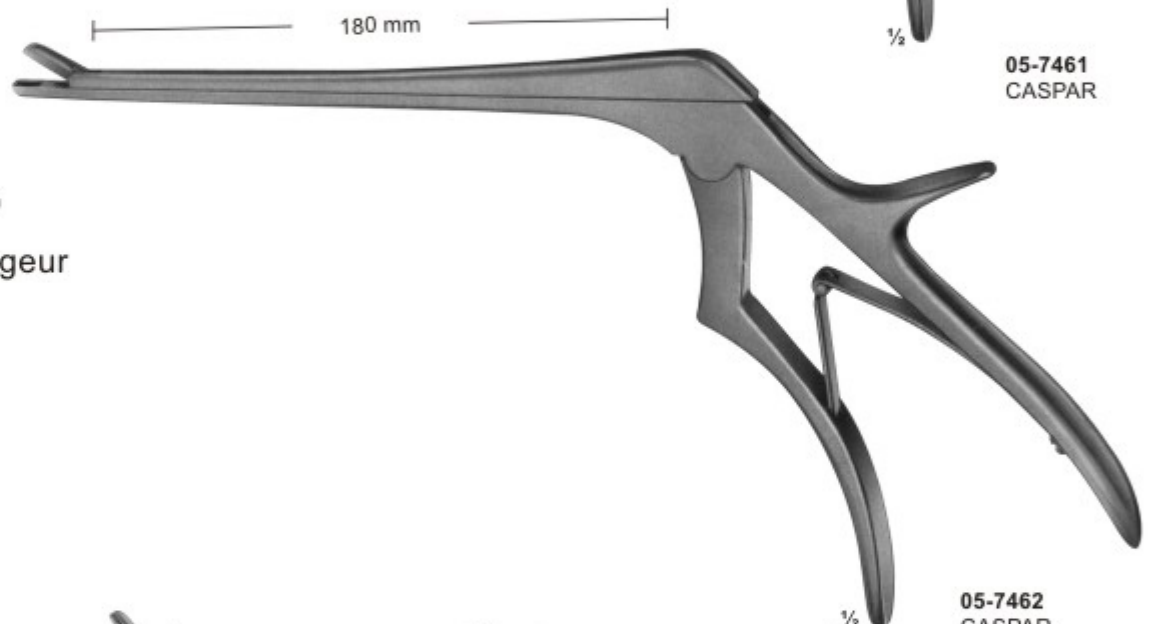
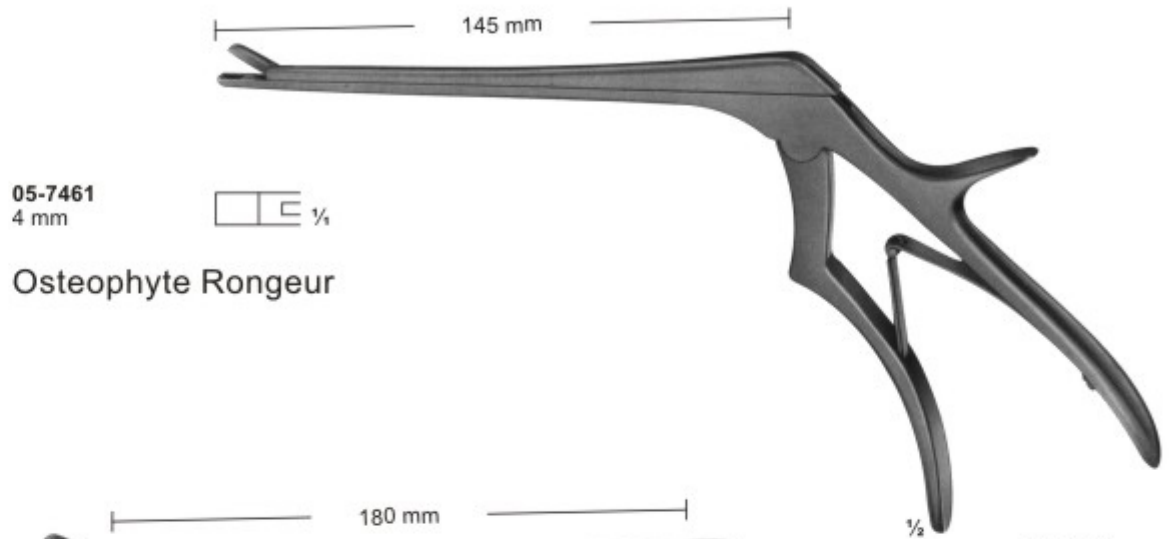

Amputation and Resection Knives



1/2
06-8001
Length of blade
Phalangeal knife
105 mm

1/2
06-8002
Length of blade
Interosseous knife
110 mm

1/2
06-8003
Length of blade
Periosteum knife
with raspator
65 mm

1/2
06-8004 - 06-8005
LANGENBECK
Length of blades
Resection knives
55 mm

06-8004 **06-8005**

Amputation Retractors

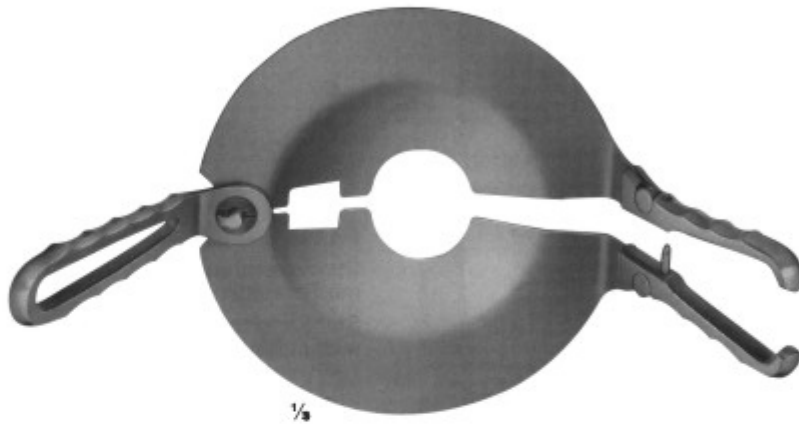

06-8006
PERCY
removeable handles

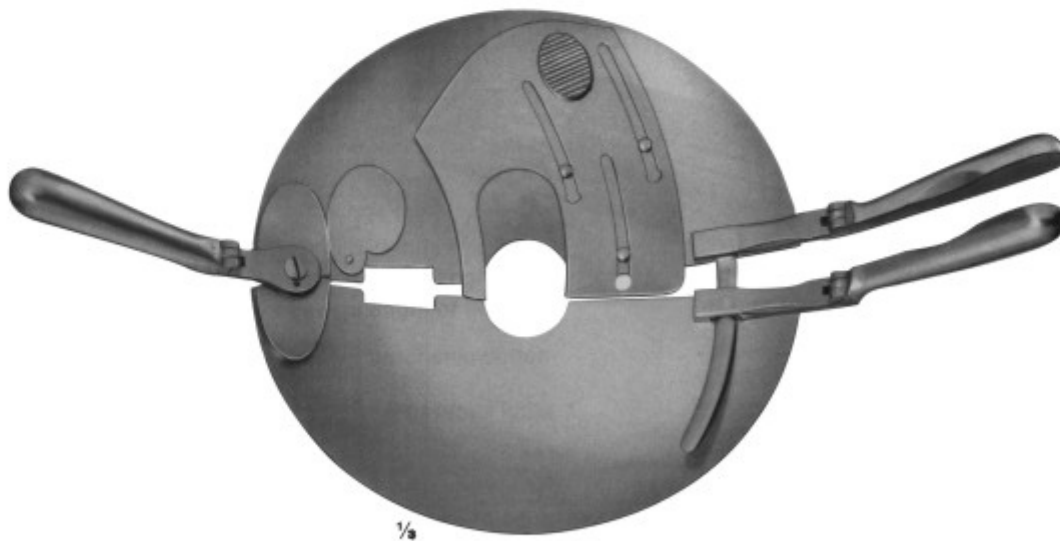

06-8007
PERCY
reversible handles

Amputation Saws



06-8008
CHARRIERE
Length of blade
215 mm
complete with one saw
blade each(06-8009 and 06-8010)
350 mm

Spare saw blades, carbon steel
06-8009 12 mm
06-8010 20 mm

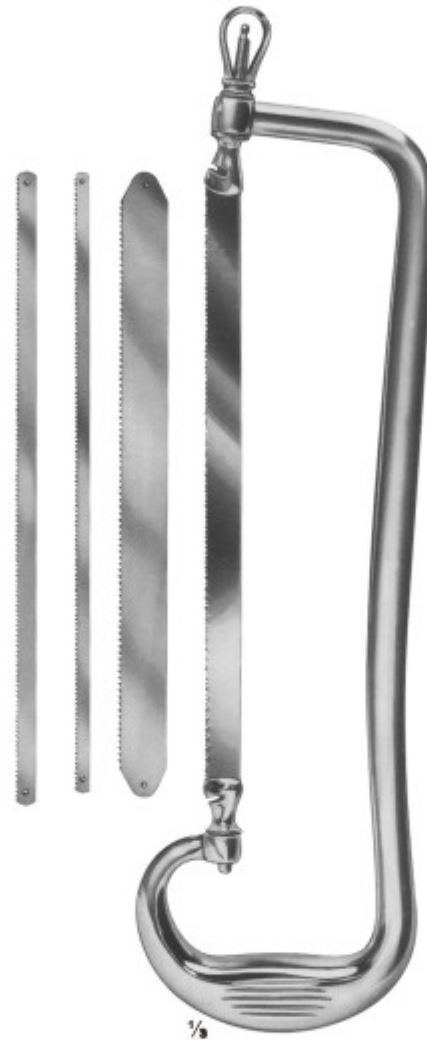

06-8011
RUST
Length of blade
235 mm
complete with one saw
blade each(06-8013, 06-8014
and 2 saw blades 06-8015)
390 mm
06-8012 Bow only

Spare saw blades, carbon steel
06-8013 6 mm
06-8014 8 mm
06-8015 12 mm
06-8016 20 mm

Amputation Saws

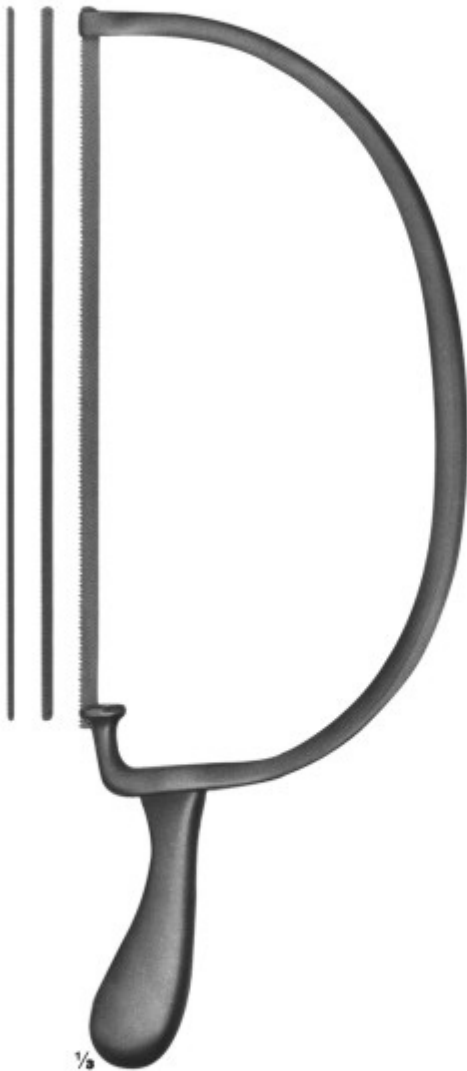

06-8017
BIER
Length of blade
270 mm
complete with one saw
blade each(**06-8018**, **06-8019** and **06-8020**)
420 mm

Spare saw blades, carbon steel
06-8018 4 mm
06-8019 6 mm
06-8020 8 mm



06-8021
CHARRIERE
Length of blade
180 mm
Spare saw blade,
carbon steel (**06-8022**)
270 mm

06-8023
CHARRIERE
Length of blade
240 mm
Spare saw blade,
carbon steel(**06-8024**)
340 mm



06-8025
SATTERLEE
Length of blade
200 mm
Spare saw blade,
carbon steel(**06-8026**)
290 mm



06-8027
LANGENBECK
Length of blade
115 mm
Metacarpal saw
235 mm

Wire Saws And Conductor



06-8028 - 06-8031
OLIVECRONA
06-8028 300 mm
06-8029 400 mm
06-8030 500 mm
06-8031 700 mm



06-8032 - 06-8035
GIGLI
06-8032 300 mm
06-8033 400 mm
06-8034 500 mm
fine, 6 wires twisted
06-8035 500mm
coarse, 4 wires twisted



06-8036
GIGLI
Handle



06-8037
LEBSCHE
Conductor for
wire saws, malleable
250 mm

Elevators and Bone Levers

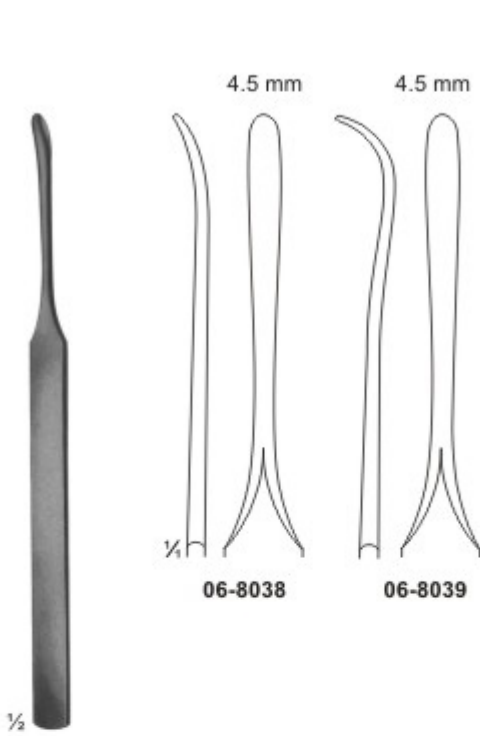

06-8038 - 06-8039
KOENIG
 155 mm



06-8040
WILLIGER
 165 mm

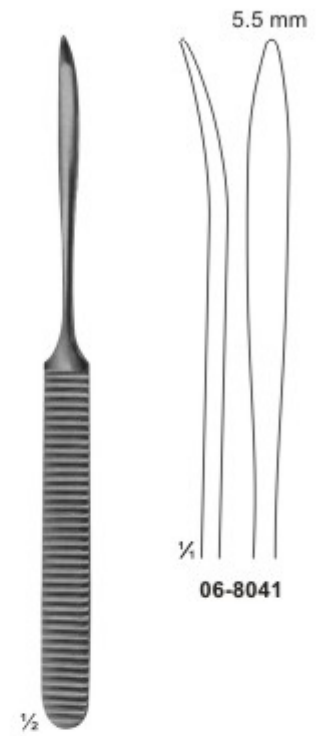

06-8041
WILLIGER
 170 mm

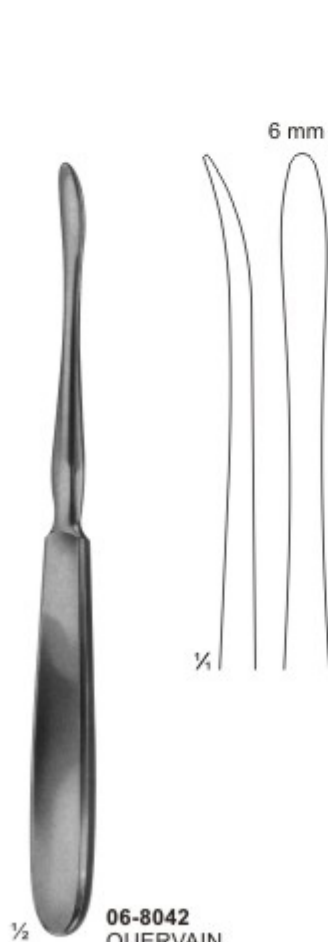

06-8042
QUERVAIN
 195 mm

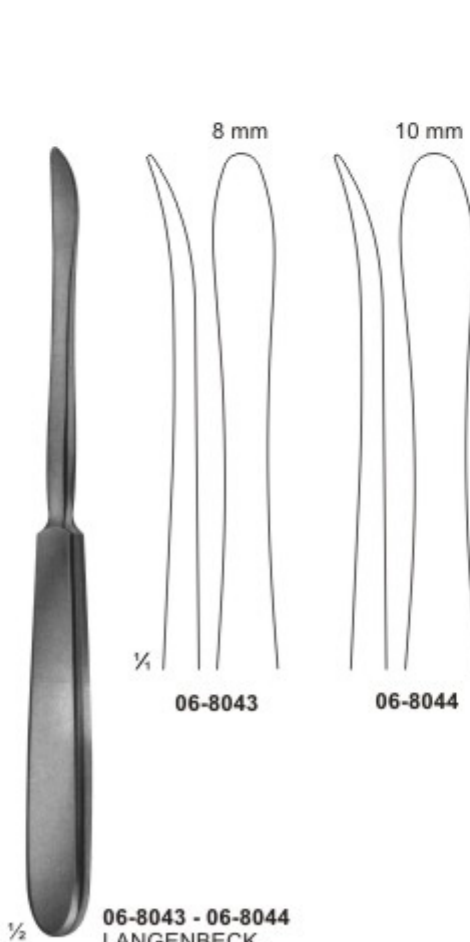

06-8043 - 06-8044
LANGENBECK
 195 mm

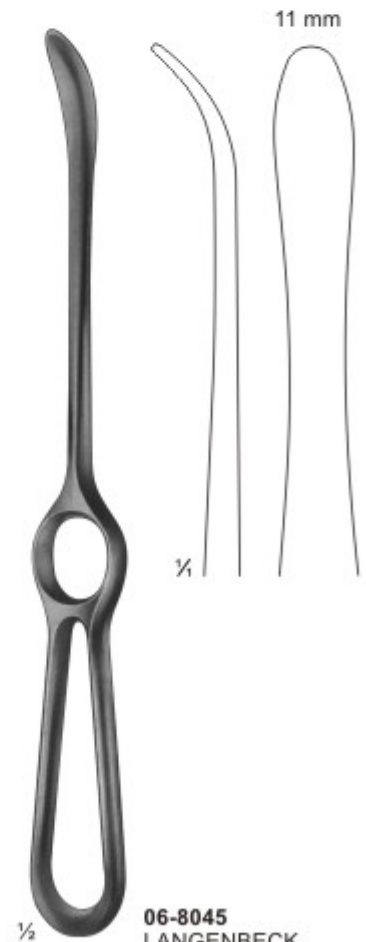

06-8045
LANGENBECK
 230mm

Bone Levers

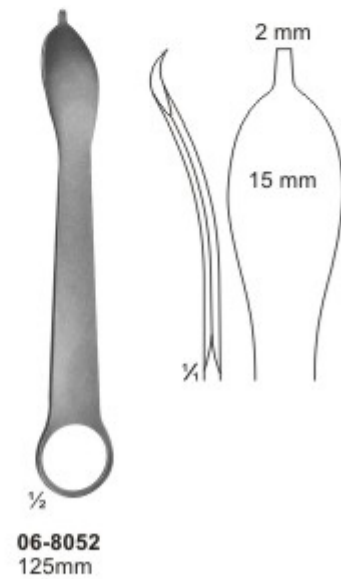
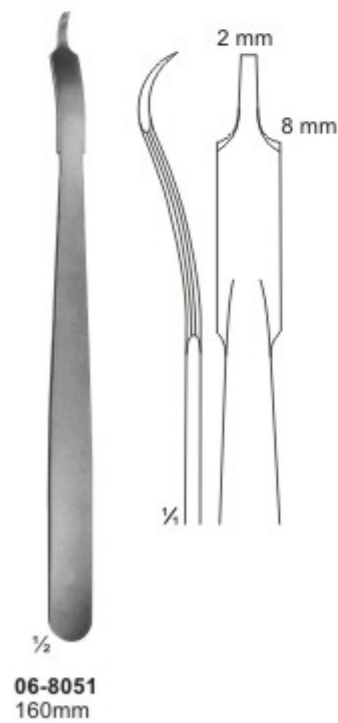
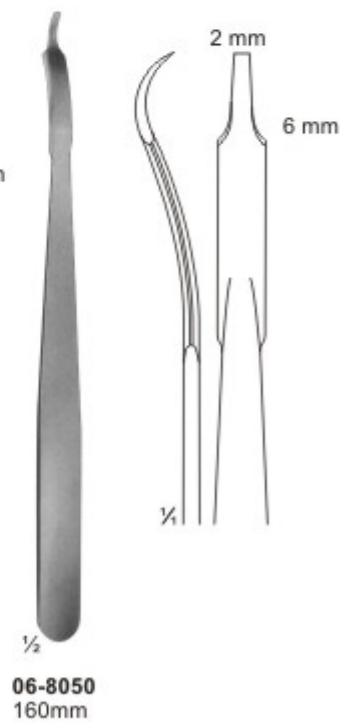
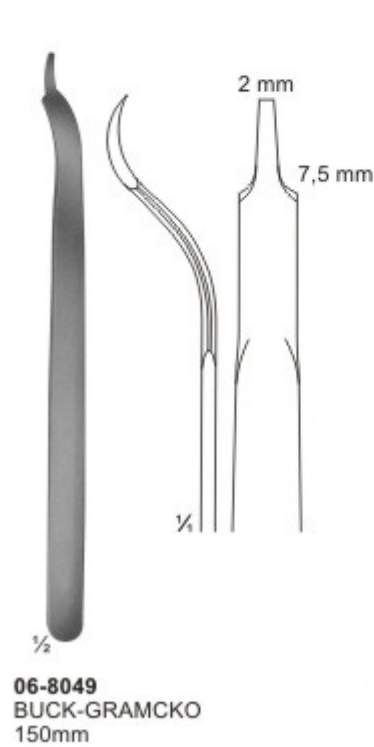
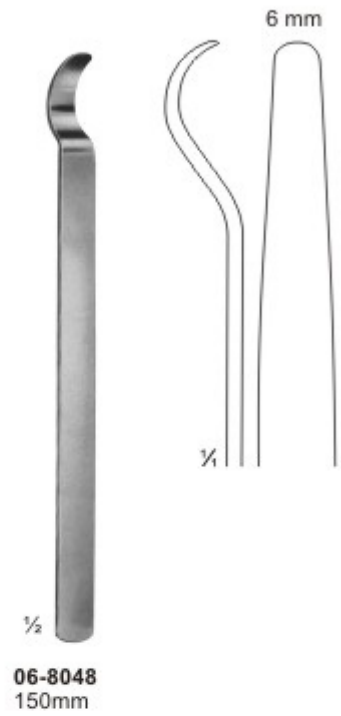
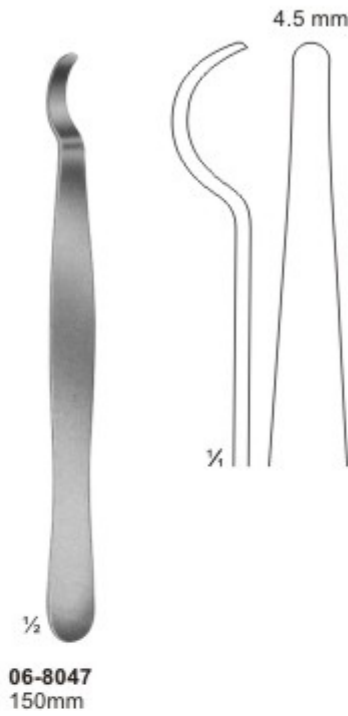
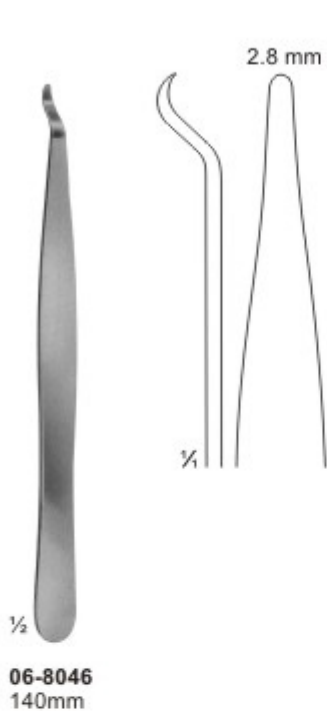

Bone Levers



06-8058
WAGNER
220 mm

06-8059
220 mm

06-8060
240 mm

06-8061
240 mm

Bone Levers

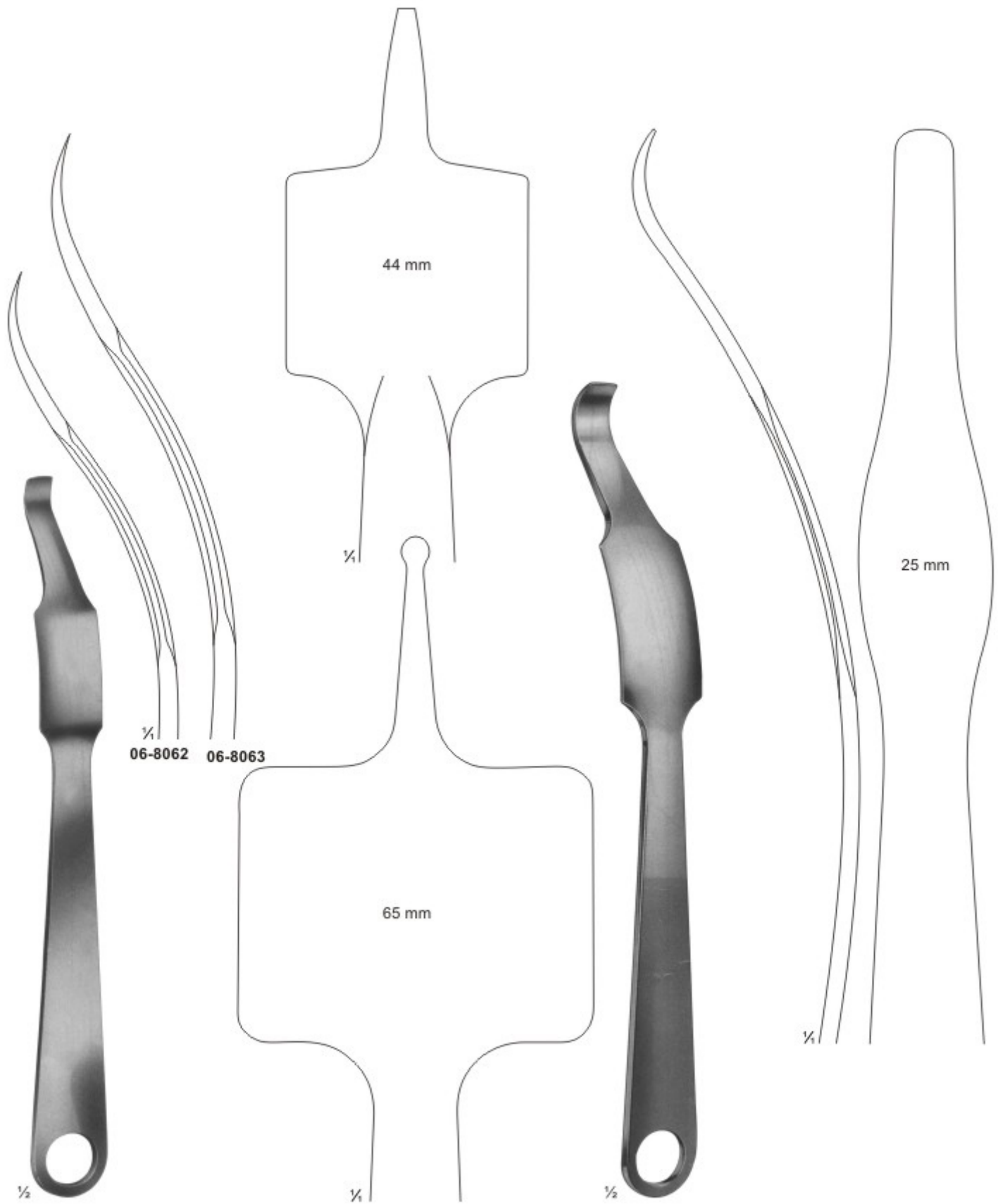

06-8062 - 06-8063
VERBRUGGE-MULLER
06-8062 240 mm
06-8063 255 mm

06-8064
260 mm

Bone Levers

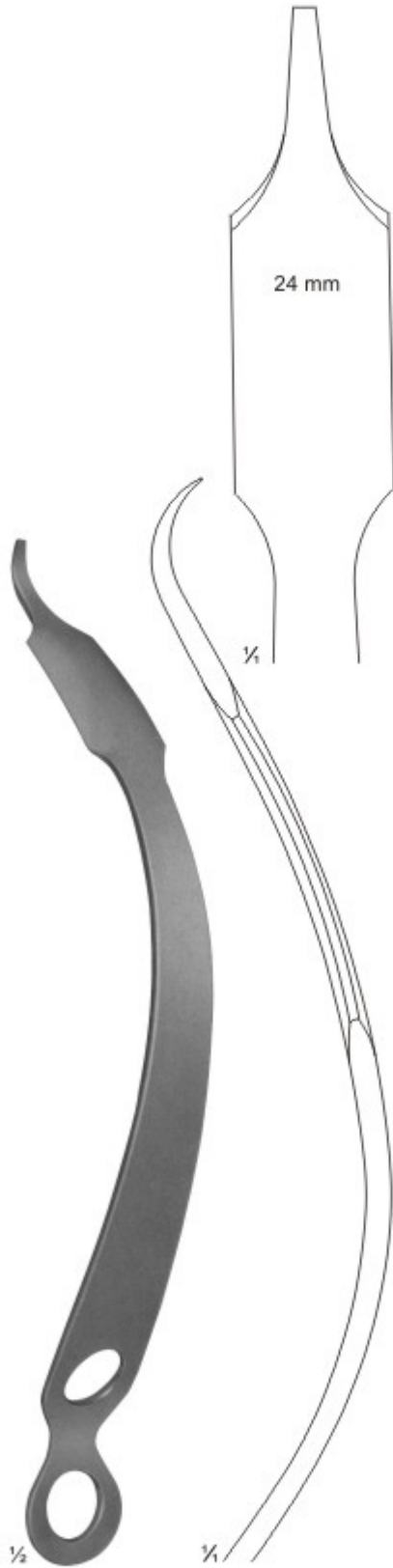

06-8065
HOHMANN-ALDINGER
270 mm



06-8066
SCHUMACHER mod. WAGNER
345 mm

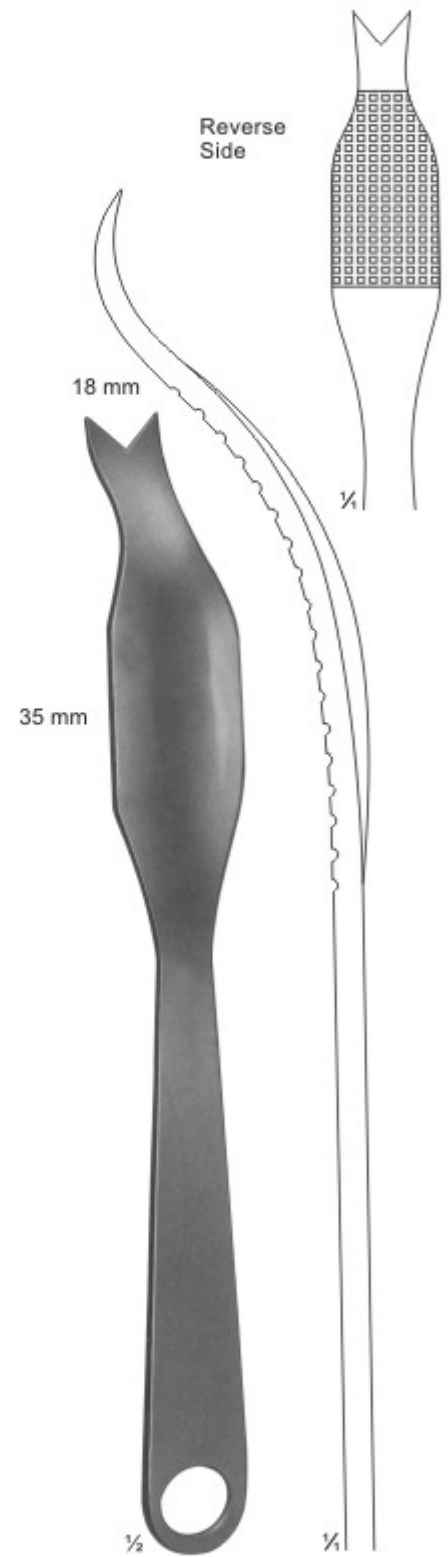

06-8067
SCHUMACHER
290 mm

Special Bone Levers

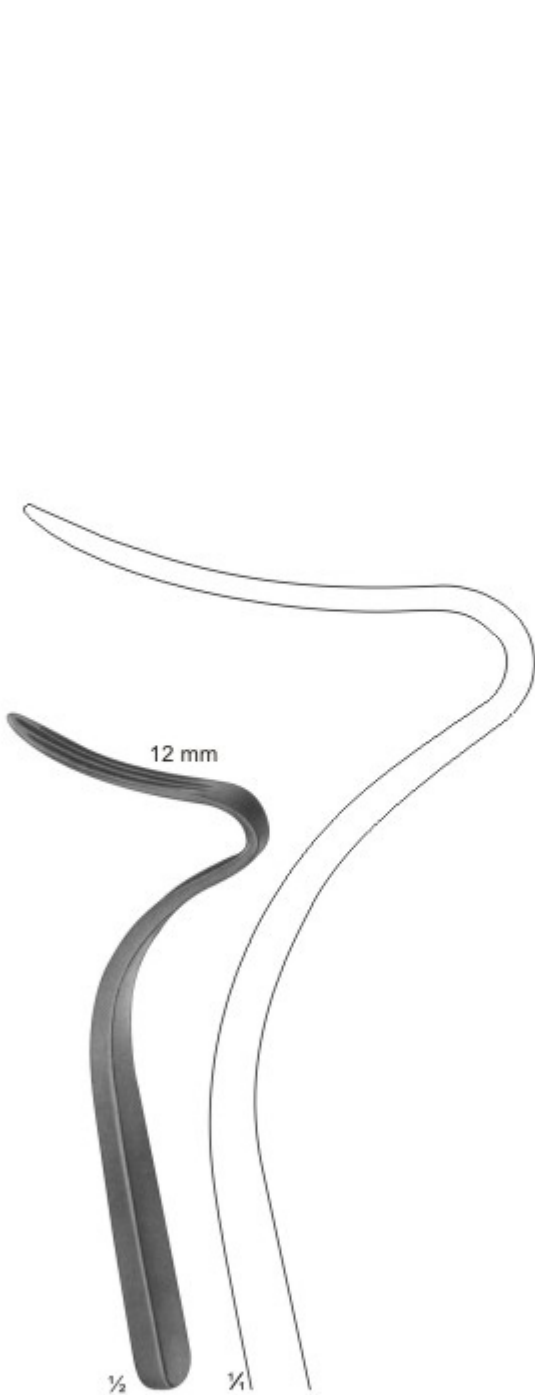

06-8068
TAGER
Bone lever for
angle joint operations
175 mm



06-8069
BENNETT
235 mm

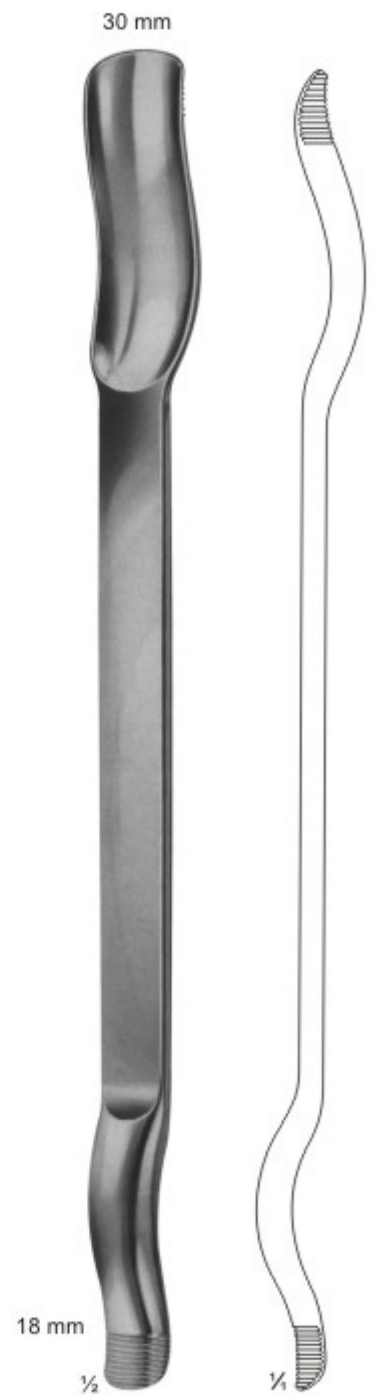

06-8070
MURPHY-LANE
Luxation lever
340 mm

Raspatories

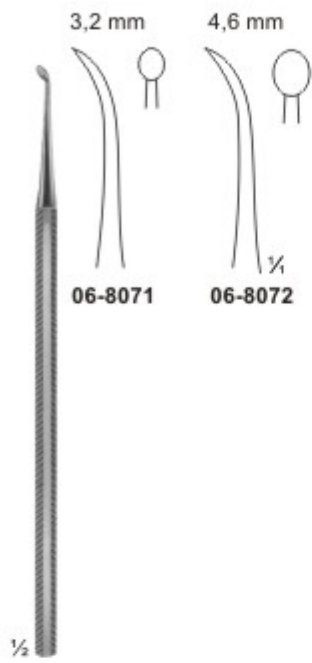

06-8071 - 06-8072
PARTSCH
150 mm

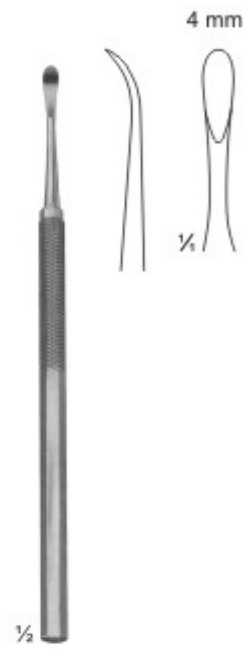

06-8073
PARTSCH mod. LANGE
145 mm



06-8074
MC KENTY
155 mm

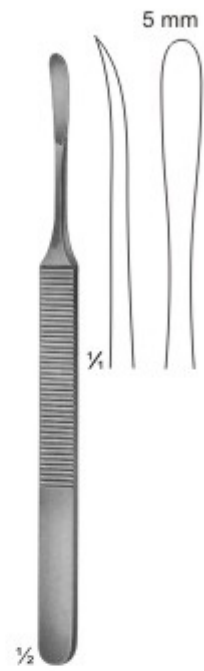

06-8075
KOENIG
155 mm

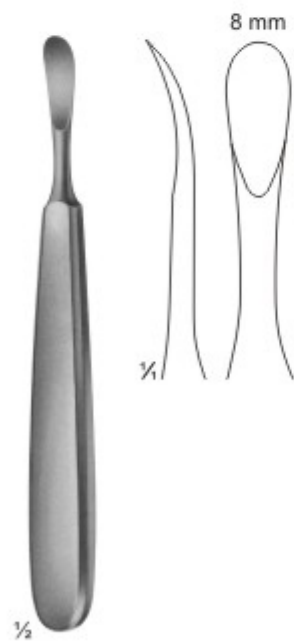

06-8076
TRELAT
150 mm

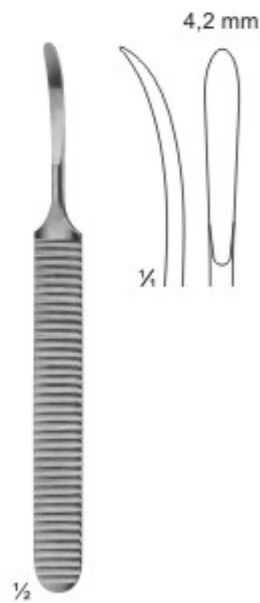

06-8077
WILLIGER
140 mm



06-8078
WILLIGER
160 mm

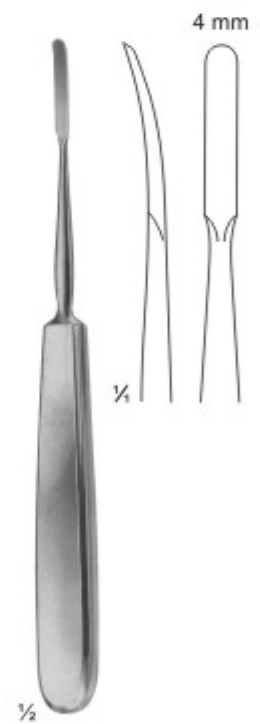

06-8079
JOSEPH
170 mm

Raspatories

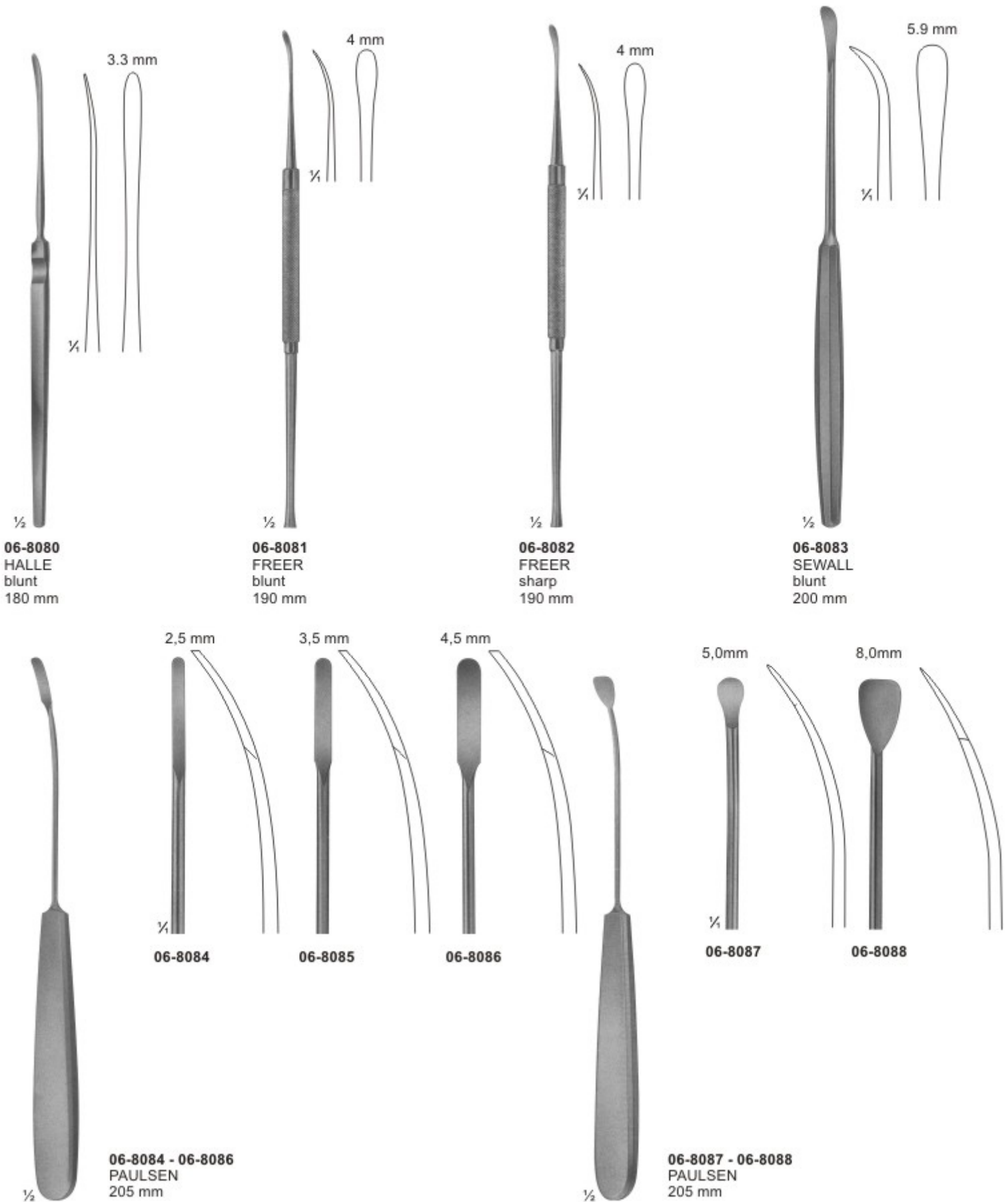

Raspatories



06-8089
KILLIAN
sharp/blunt
185 mm

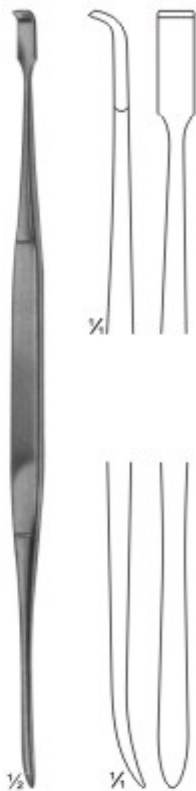

06-8090
HOWARTH
sharp/blunt
215 mm



06-8091
KILLIAN
sharp/blunt
185 mm

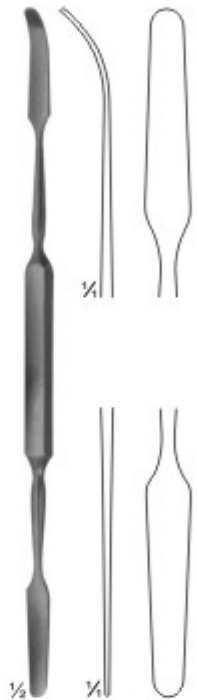

06-8092
MAC DONALD
blunt/blunt
185 mm

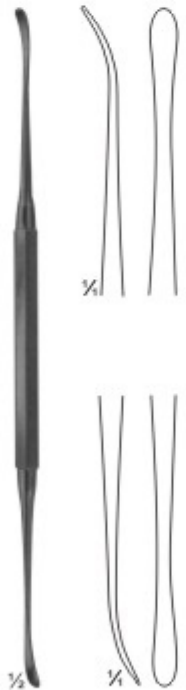

06-8093
FREER
sharp/blunt
185 mm

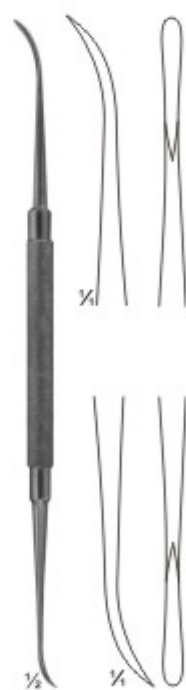

06-8094
FREER-YASARGIL
sharp/sharp
185 mm

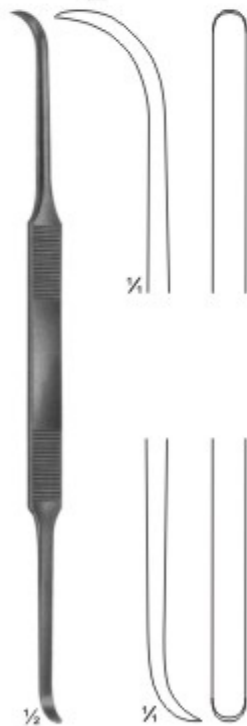

06-8095
COTTLE
sharp/sharp
200 mm

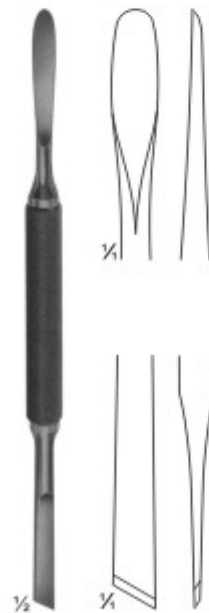

06-8096
MEAD
sharp/sharp
165 mm

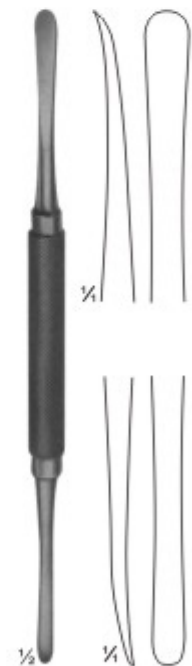

06-8097
MOLT
sharp/sharp
180 mm

Raspatories

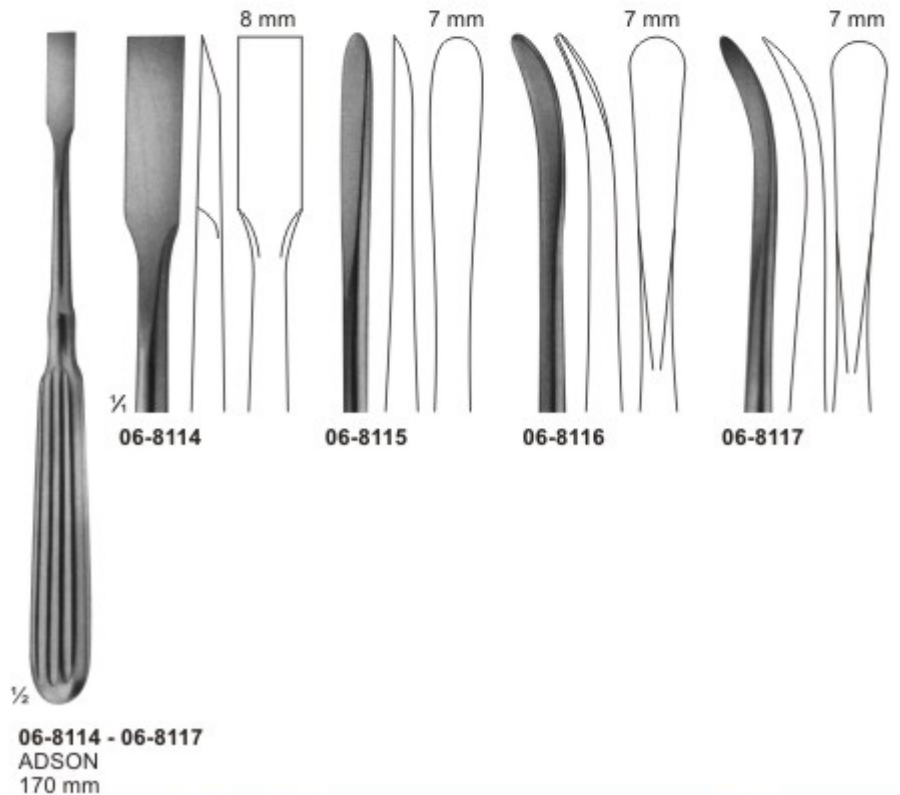
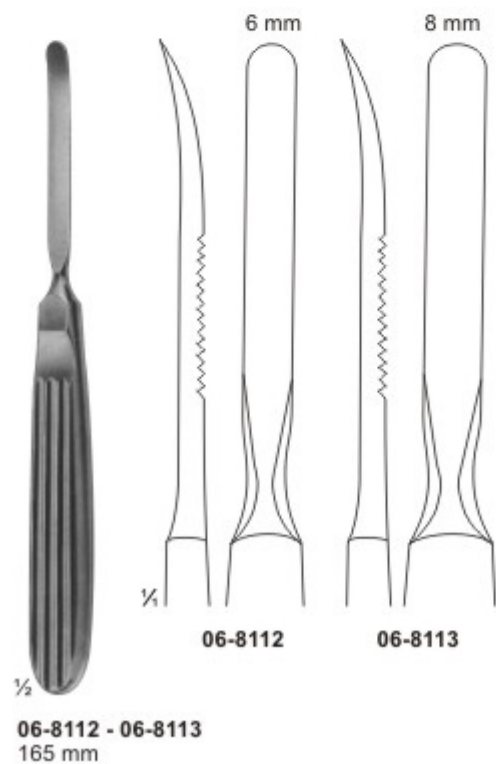
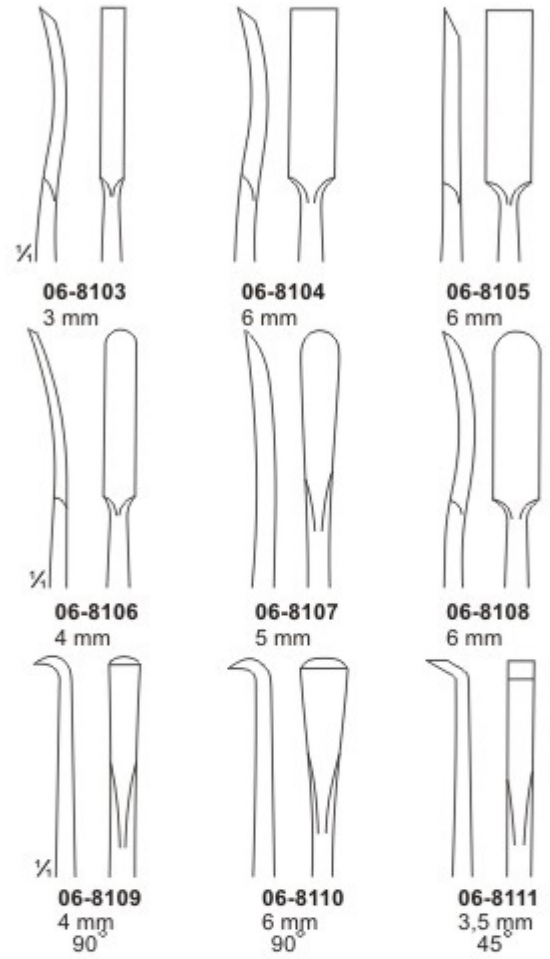
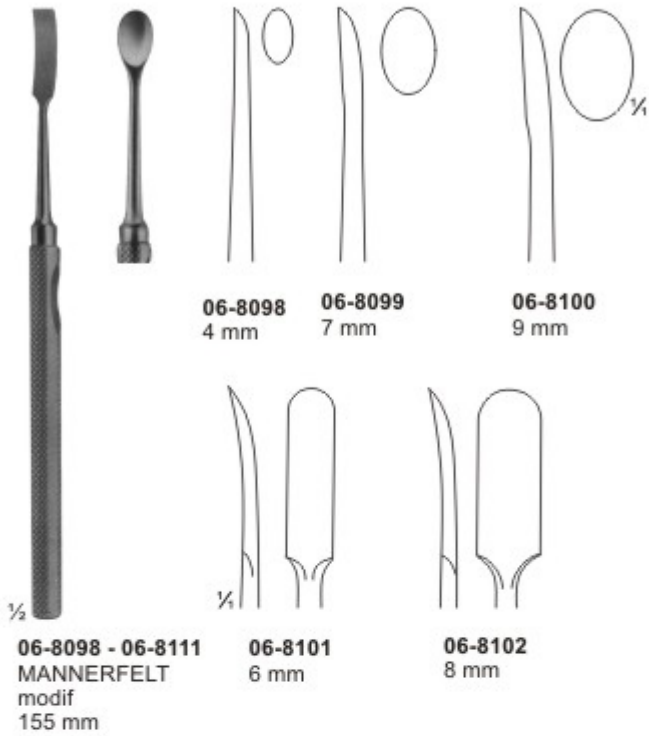

Raspatories

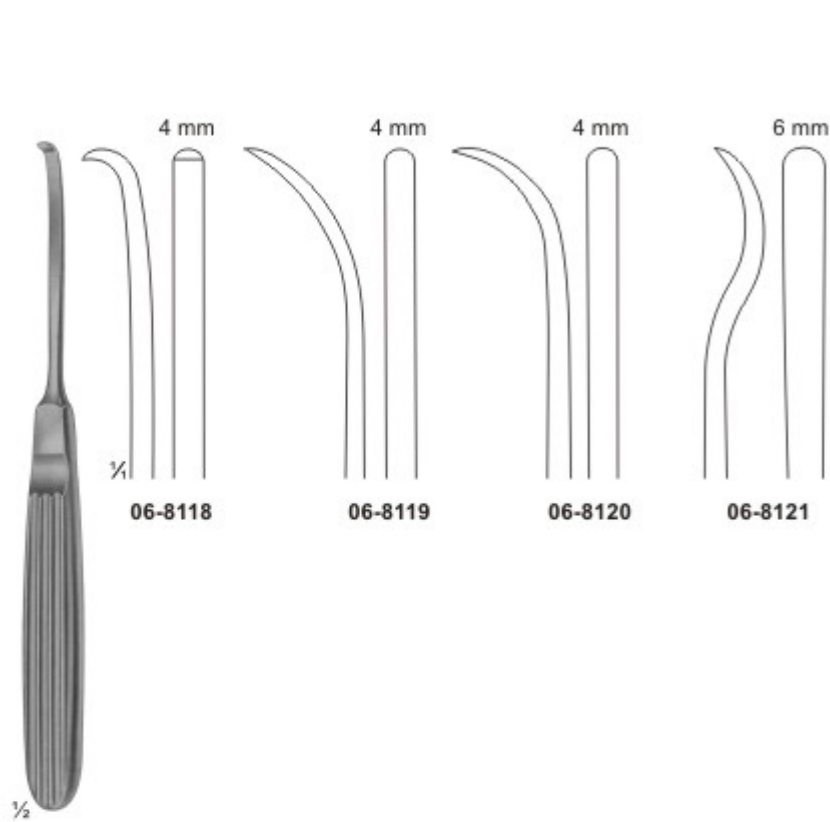

06-8118 - 06-8121
MUEHLING
170 mm

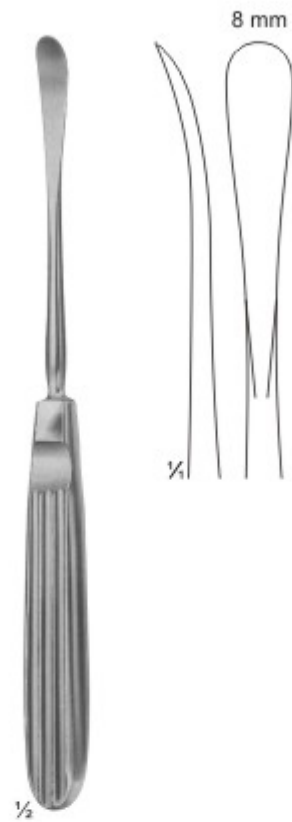

06-8122
COTTLE
195 mm

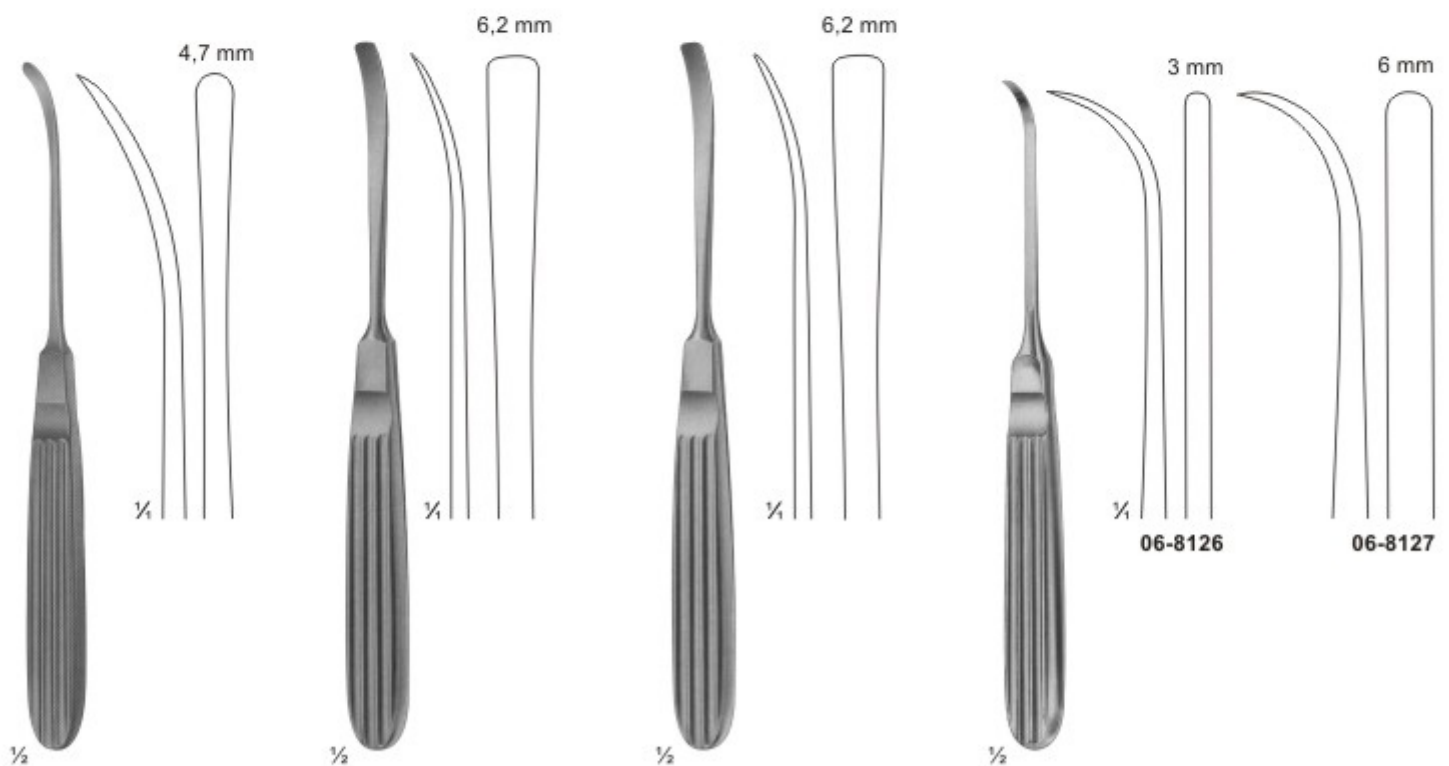

06-8123
LANDOLT
175 mm

06-8124
CASPAR
180 mm

06-8125
CASPAR
180 mm

06-8126 - 06-8127
170 mm

Raspatories

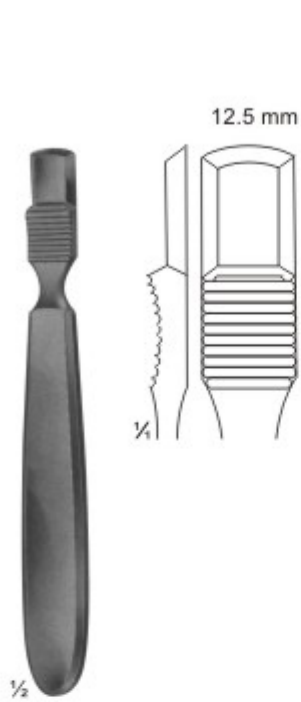

06-8128
FARABEUF
140 mm

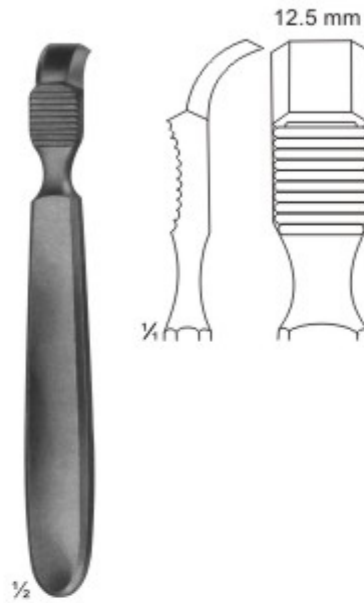

06-8129
FARABEUF
140 mm

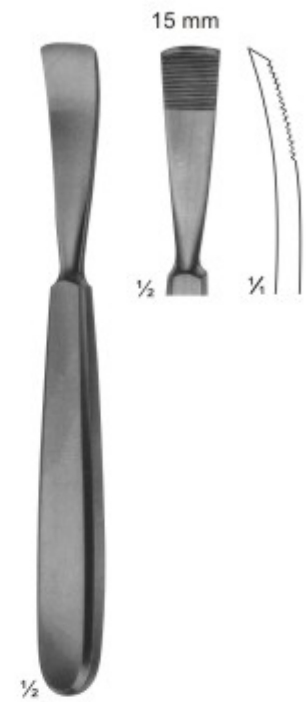

06-8130
JANSEN
165 mm

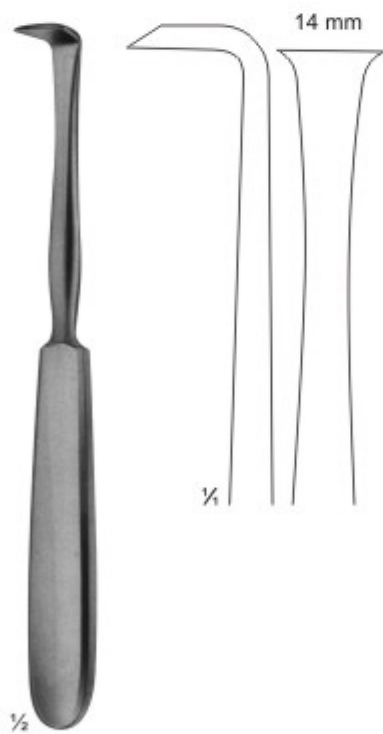

06-8131
LANGENBECK
180 mm

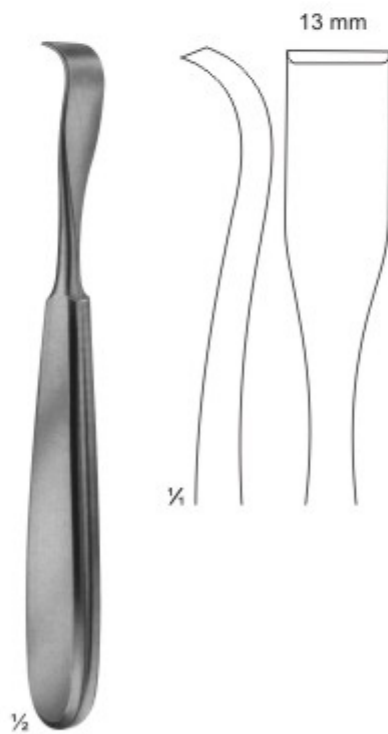

06-8132
SCHNEIDER
175 mm

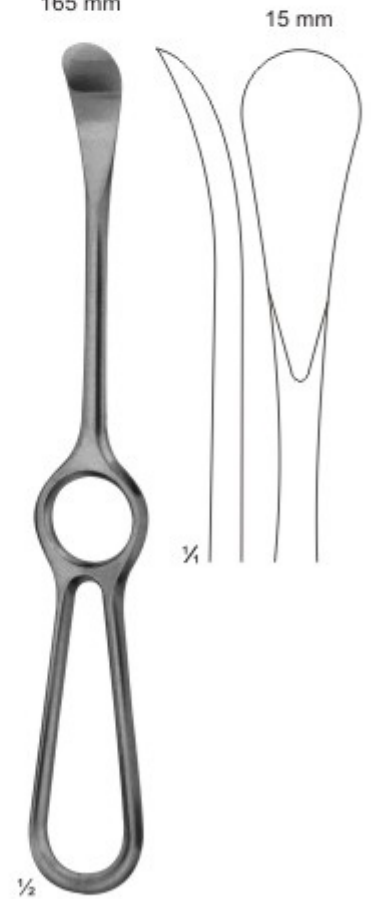

06-8133
SEDILLOT
215 mm

Raspatories

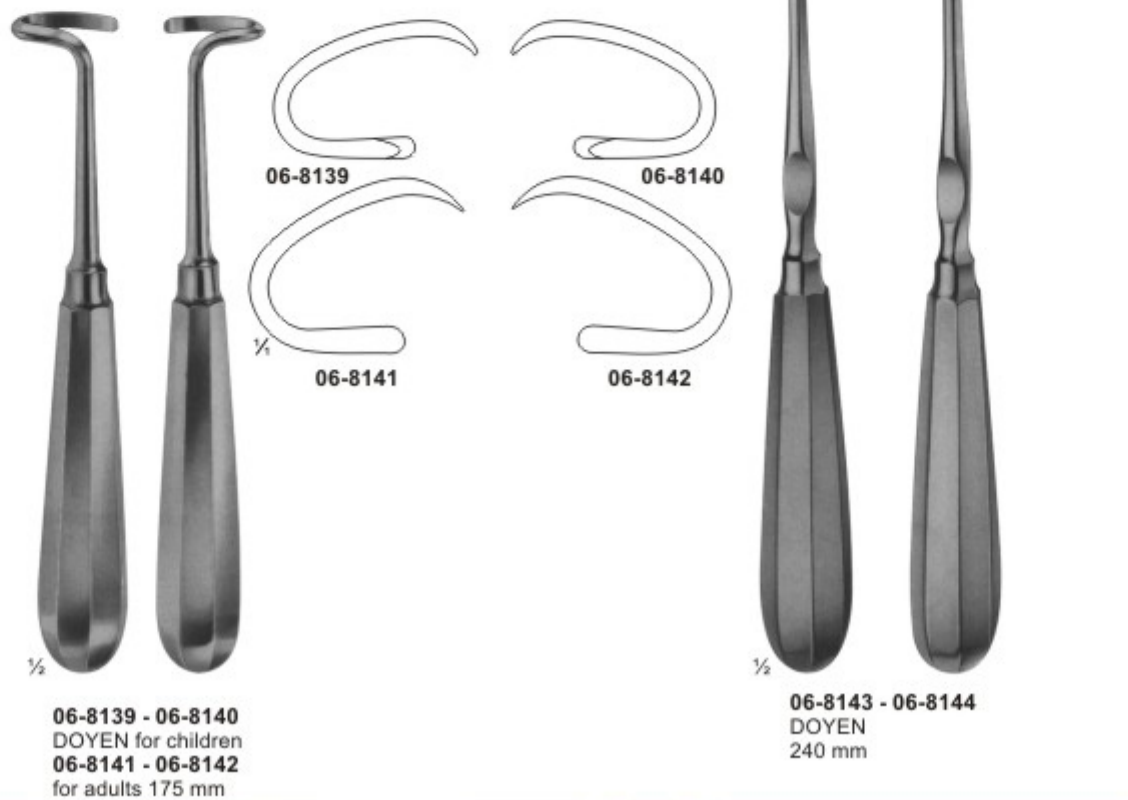
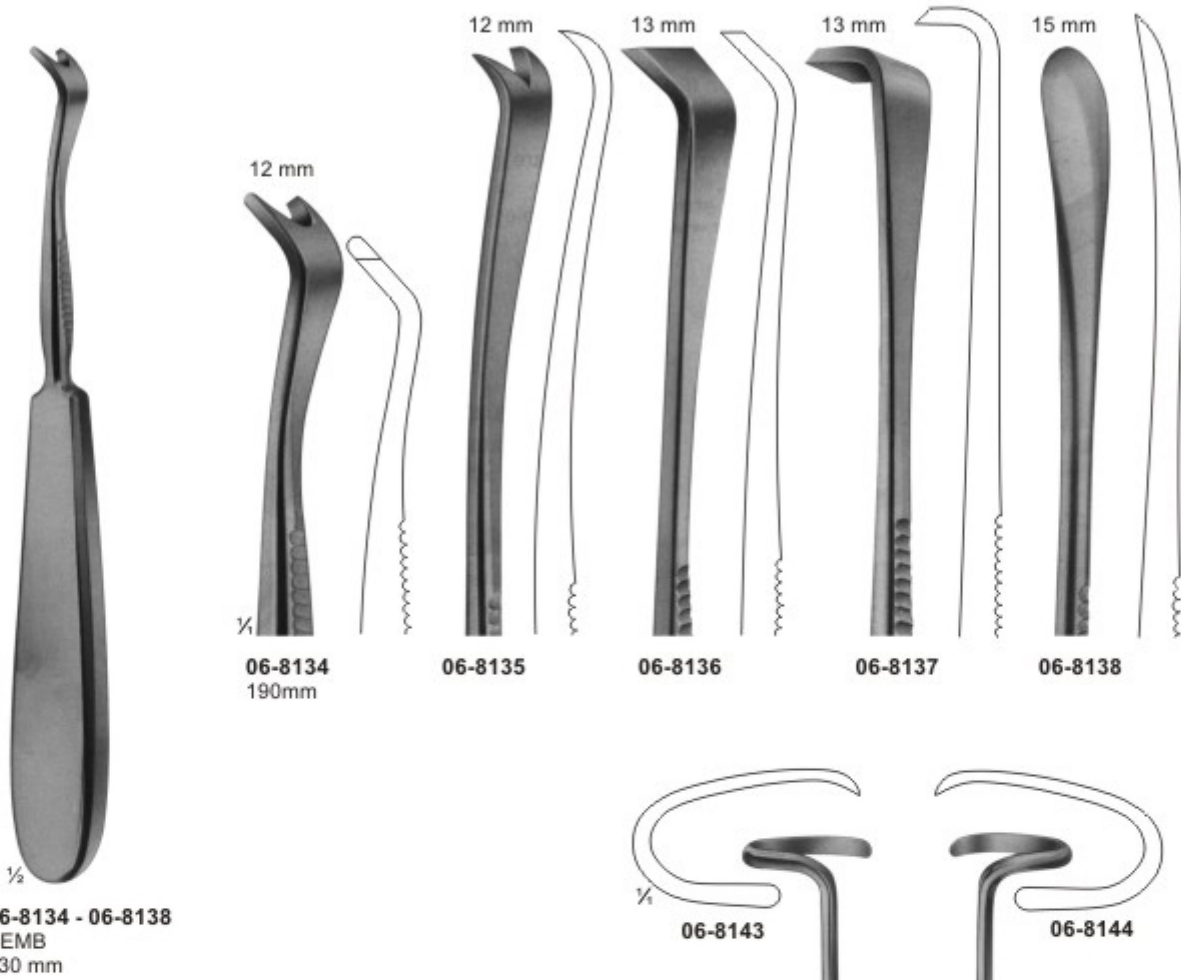

Raspatories with HARTPRESS-handle

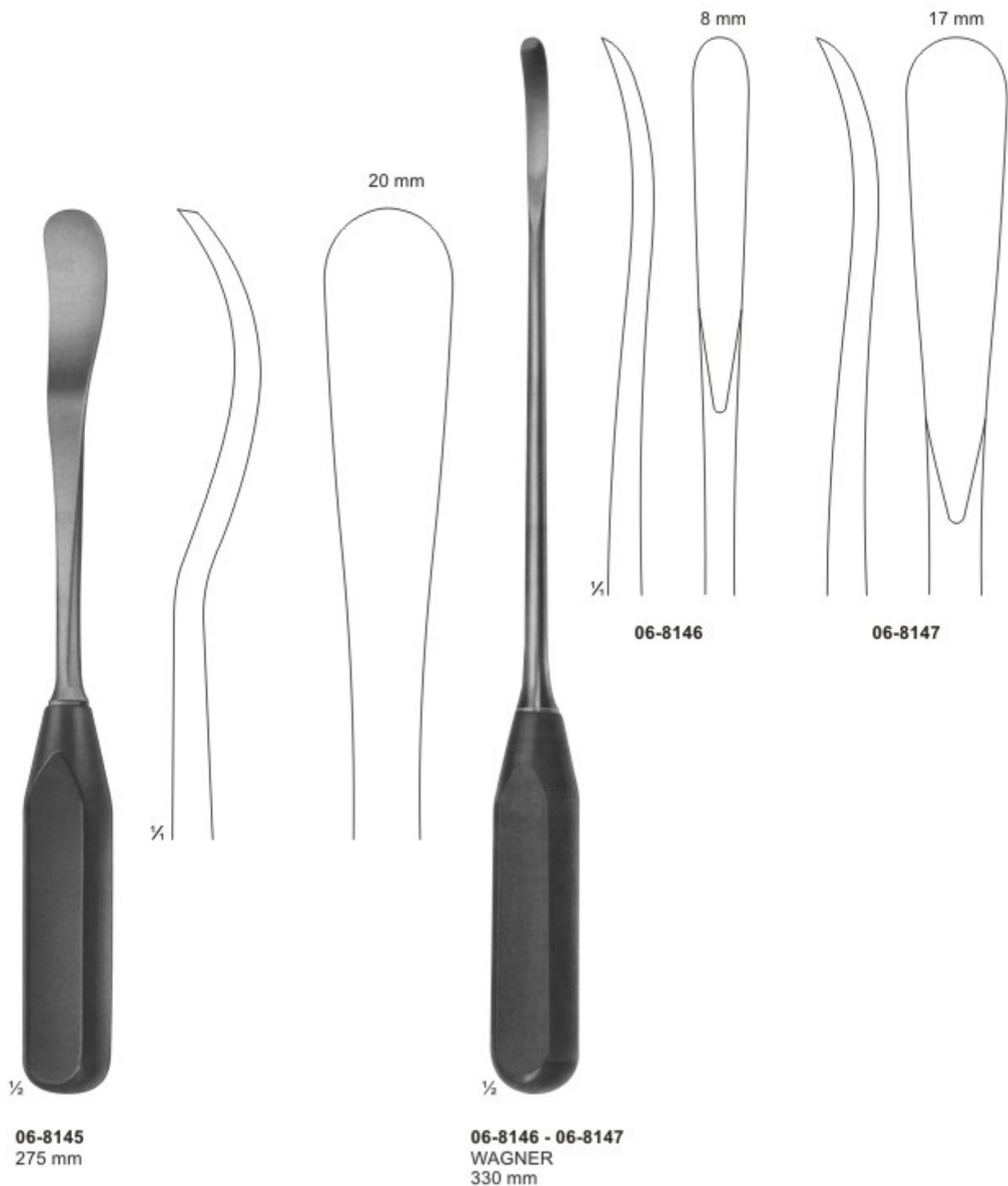

Bone File and Rasps

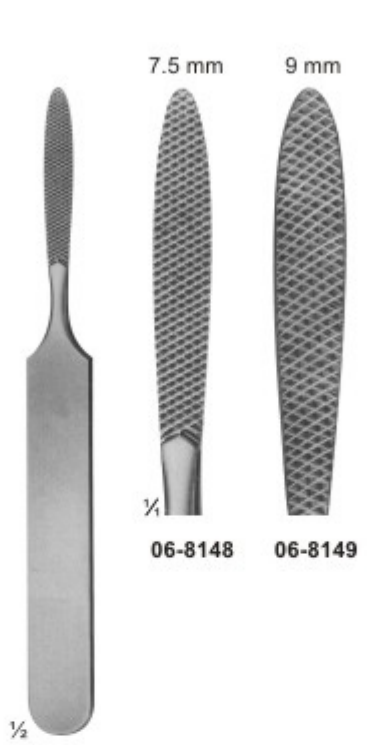

06-8148
JOSEPH
fine, chequered

06-8149
coarse, chequered
165 mm



06-8152
MALTZ
down stroke
180 mm



06-8153
AUFRICHT
up stroke
06-8154
down stroke
220 mm

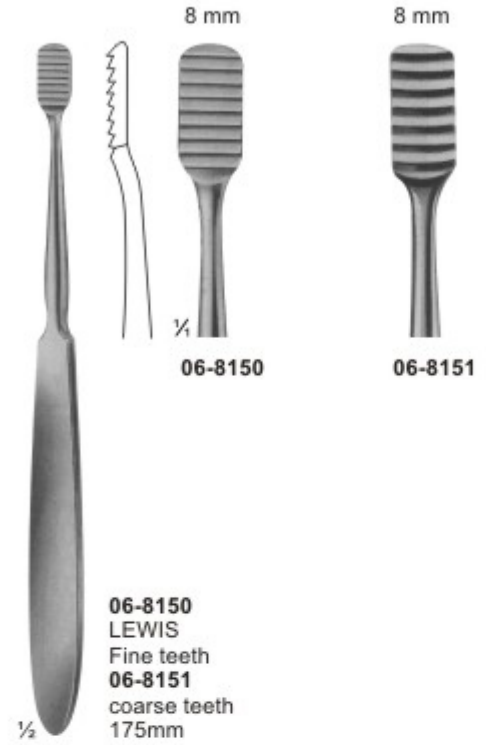

06-8150
LEWIS
Fine teeth
06-8151
coarse teeth
175mm

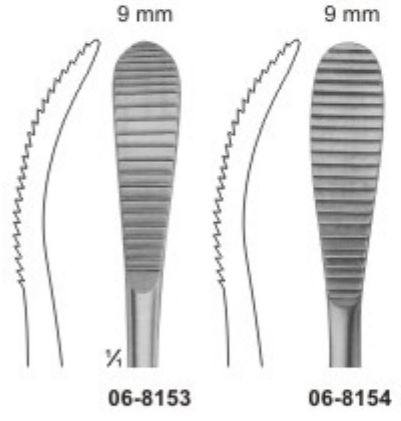

06-8153
06-8154



06-8155
GALLAHER
190 mm

Bone File and Rasps, Durogrip Rasps

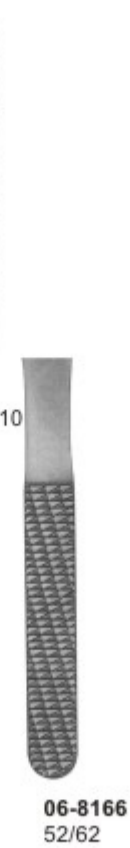
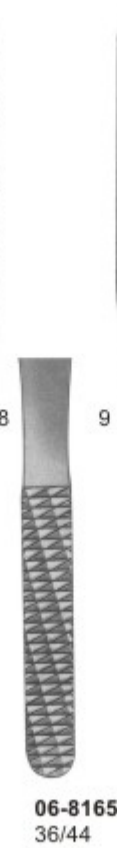
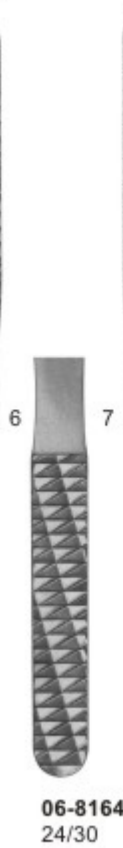
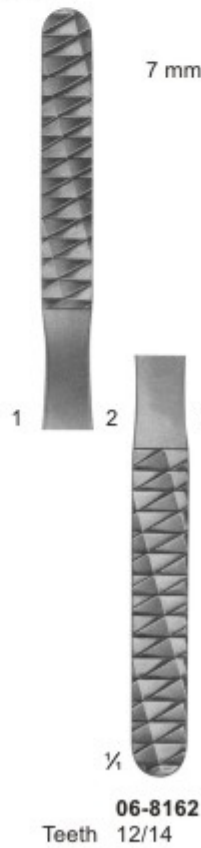
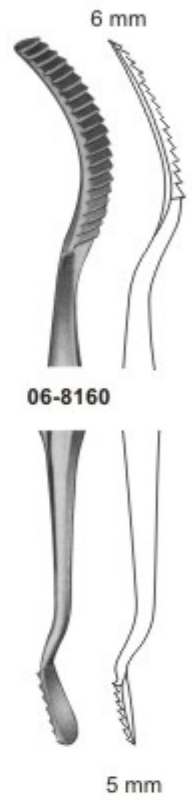
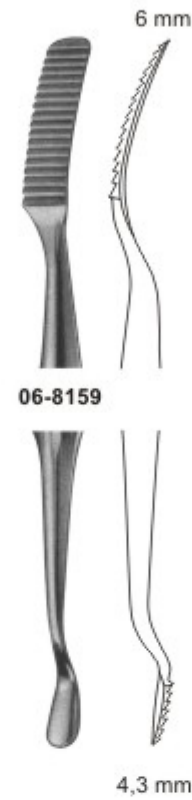

Bone File and Rasps

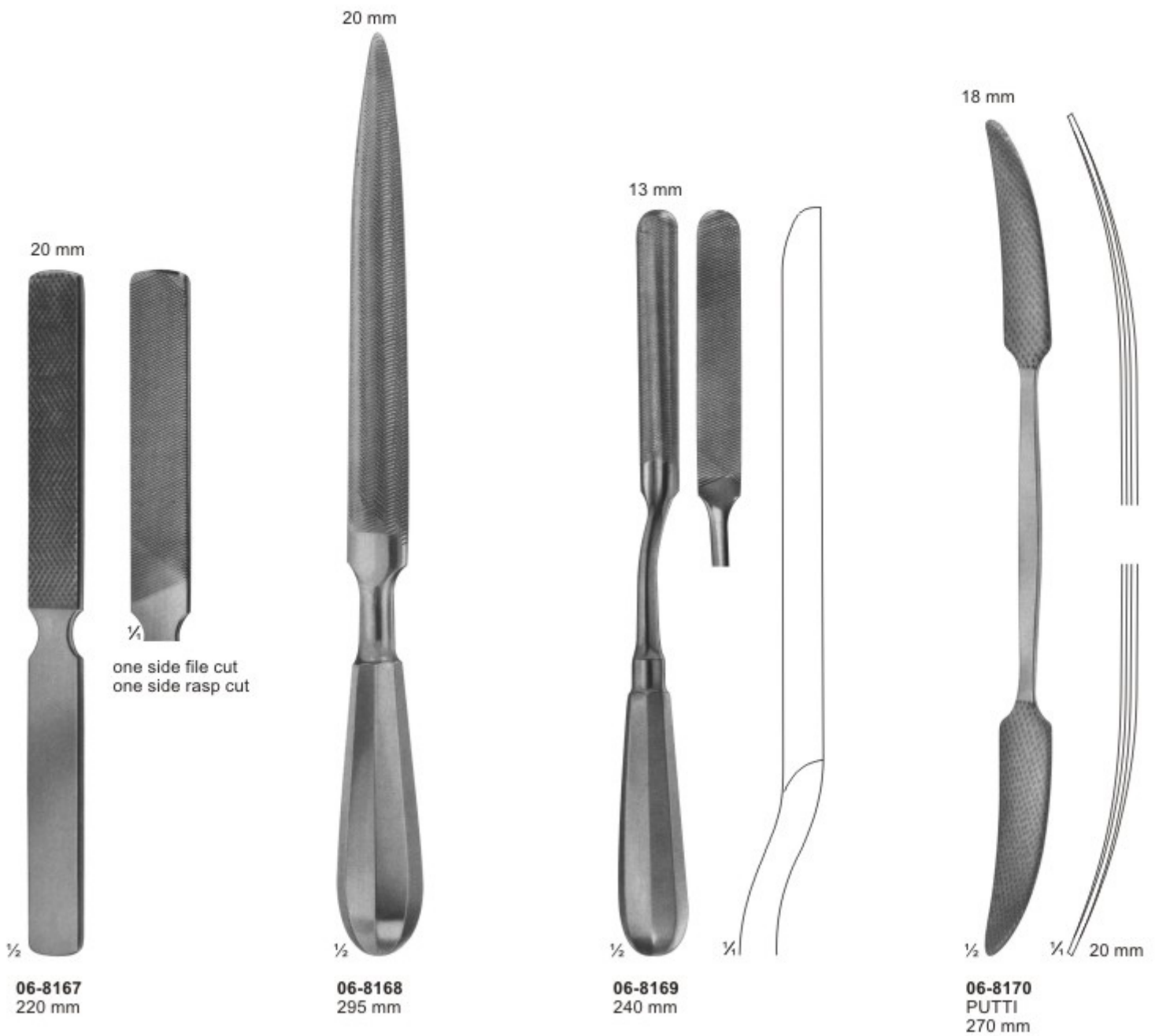

Bone Currettes



06-8171
JACOBSON
140 mm

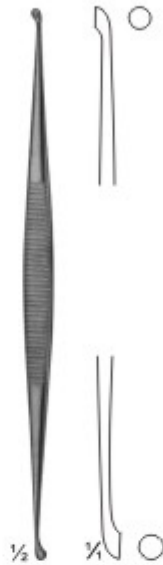

06-8172
MARTINI
140 mm



06-8173
MARTINI
140 mm



06-8174
WILLIGER
145 mm



06-8175
JANSEN
160 mm



06-8176
BARTH
180 mm



06-8177
VOLKMANN
130 mm

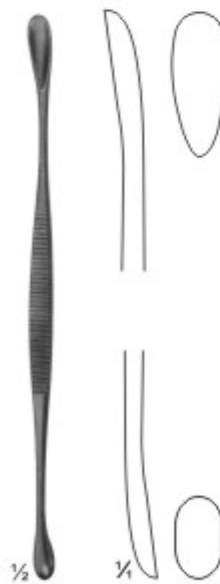

06-8178
VOLKMANN
145 mm



06-8179
VOLKMANN
170 mm

Bone Crettes



06-8180
JANSEN
160 mm

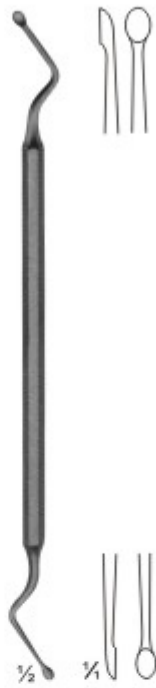

06-8181
HEMINGWAY
170 mm



06-8182
HEMINGWAY
175 mm



06-8183
LUCAS
180 mm

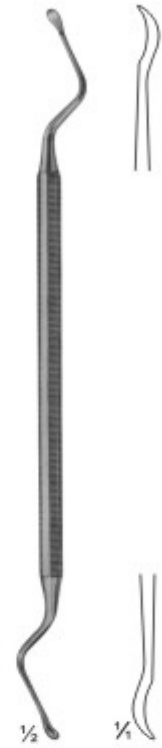

06-8184
LUCAS
185 mm



06-8185 - 06-8187
KERPEL
145 mm

06-8186 - 06-8188
KERPEL
145 mm

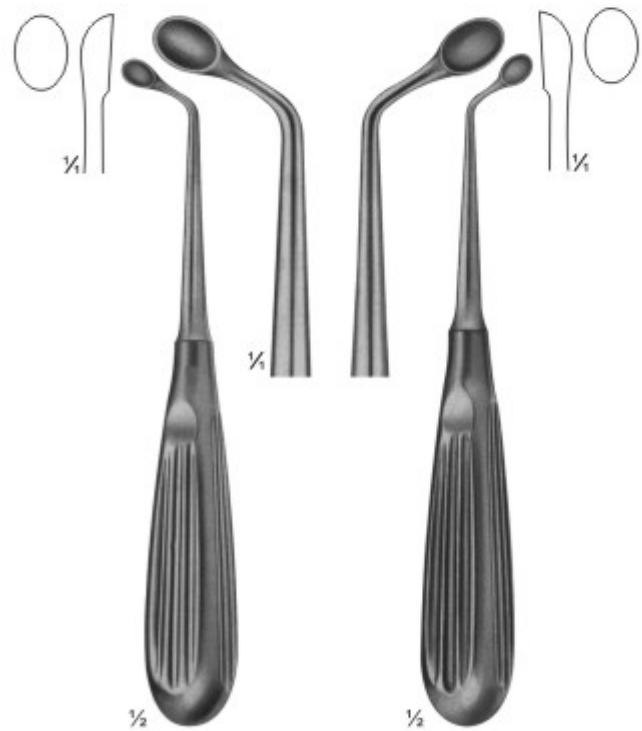

06-8189
UFFENDORDE
170 mm

06-8190
UFFENDORDE
170 mm

Bone Currettes



½



06-8191 3 mm
Fig: 000

06-8192 4 mm
00

06-8193 5 mm
0



06-8194 6 mm
Fig: 1



06-8195 8 mm
2



06-8196 10 mm
3

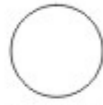

06-8197 12 mm
4

06-8191 - 06-8197
BRUNS
165 mm



½



06-8198 2,5 mm
Fig: 000



06-8199 3,4 mm
00



06-8200 4,2 mm
0



06-8201 5,2 mm
Fig: 1



06-8202 6,3 mm
2



06-8203 7,4 mm
3



06-8204 8 mm
4

06-8198 - 06-8204
SCHEDE
170 mm



½



06-8205 2,8 mm
Fig: 0000



06-8206 3,6 mm
000



06-8207 4,4 mm
00



06-8208 5,2 mm
0



06-8209 6,8 mm
1



06-8210 8,5 mm
Fig: 2



06-8211 10 mm
3



06-8212 11,5 mm
4



06-8213 13 mm
5



06-8214 14,5 mm
6

06-8205 - 06-8214
VOLKMANN
170 mm



½



06-8215 3,4 mm
Fig: 00



06-8216 5,2 mm
1

06-8215 - 06-8216
WILLIGER
170 mm

Bone Currettes



06-8217 - 06-8221
LEMPERT
215 mm



06-8222 - 06-8224
HALLE
215 mm



06-8225 - 06-8228
DAUBENSPECK
200 mm



06-8229 - 06-8232
250 mm



06-8233 - 06-8236
250 mm



06-8237 - 06-8239
BUSHE 250 mm

Bone Currettes

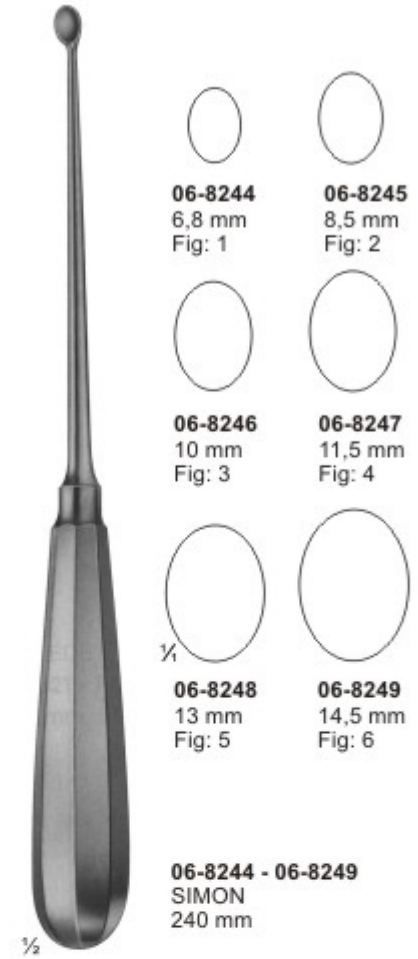

Bone Currettes With Hartpress Handle

can be sterilized in a steam sterilizer upto 3 bar over pressure (143°C).

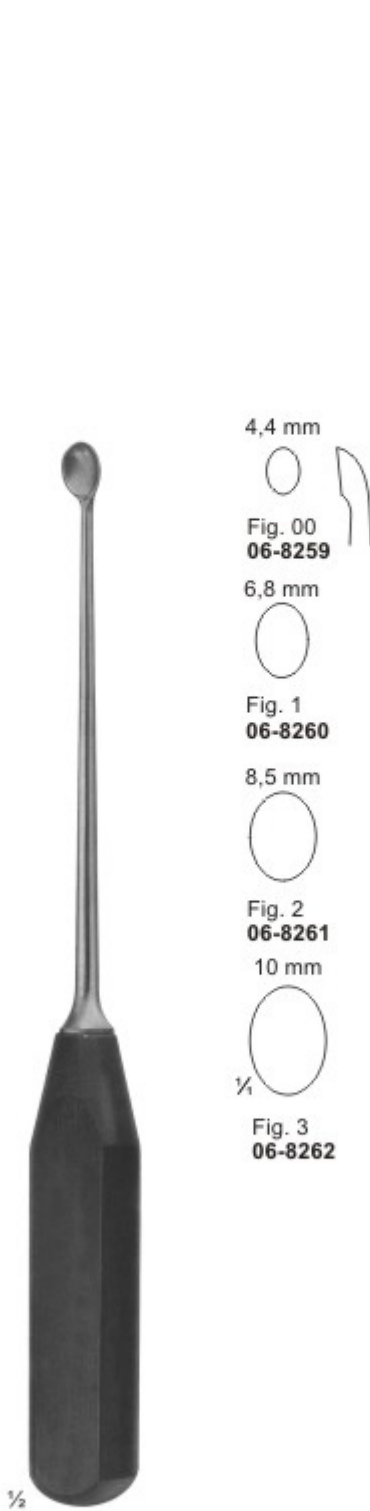

06-8259 - 06-8262
270 mm

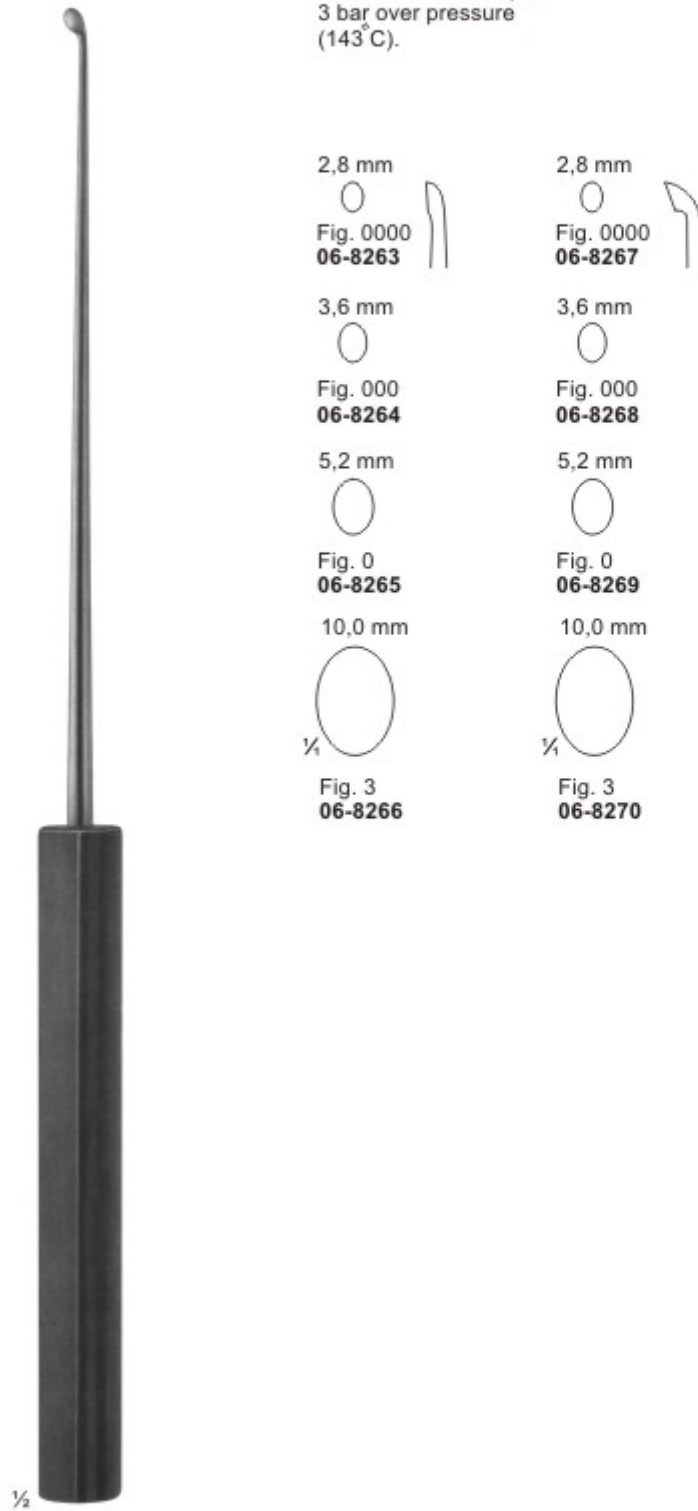

06-8263 - 06-8270
SYPERT
380 mm

Mallets Weight Refer To The Heads Of The Mallets



∅ 20 mm

½

06-8271
MEAD
185 g
with interchangeable
plastic disks
190 mm
06-8272
pair of spare disks



∅ 25 mm

½

06-8273
140 g
with interchangeable
plastic disks
185 mm
06-8274
pair of spare disks



∅ 30 mm

½

06-8275
COTTLE
240 g
1 Side flat
1 Side convex
185 mm



∅ 22 mm

½

06-8276
165 g
lead filled head
190 mm

Mallets, Weights Refer To The Heads Of The



06-8277
HAJEK
140 g
220 mm



06-8278
215 g
with interchangeable
plastic disks
245 mm
06-8279
pair of spare disks

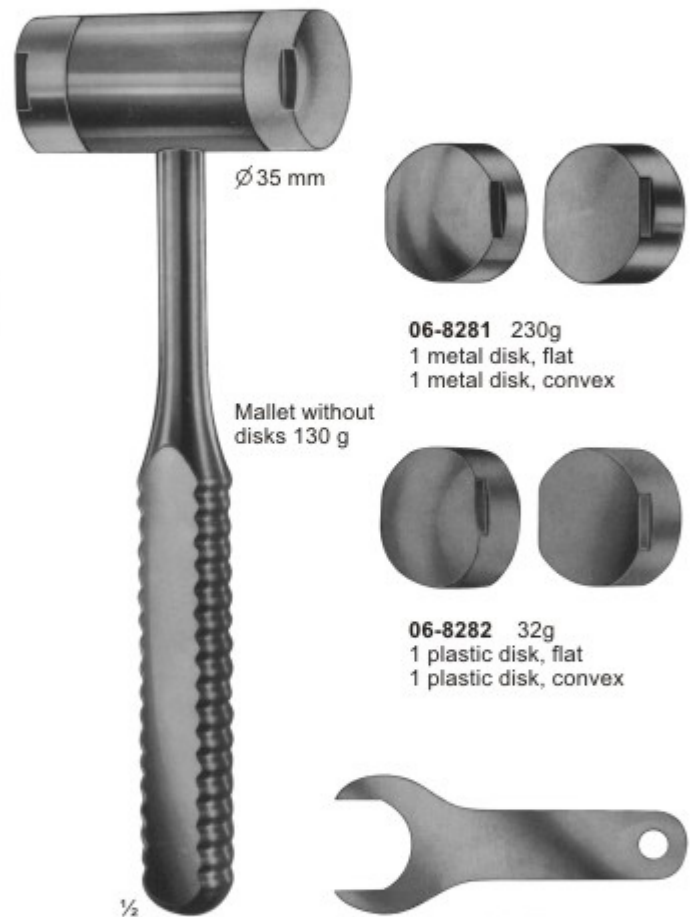

06-8280 - 06-8283
WAGNER
complete with:
1 pair of metal disks (**06-8281**) and
1 pair of plastic disks (**06-8282**) and
1 wrench (**06-8283**)
235 mm

06-8281 230g
1 metal disk, flat
1 metal disk, convex

Mallet without
disks 130 g

06-8282 32g
1 plastic disk, flat
1 plastic disk, convex

06-8283
Wrench

Mallets Weight Refer To The Heads Of The Mallets



∅45 mm

½

06-8284 300g
BERGMANN
245 mm



∅30 mm

½

06-8285 300g
BERGMANN
235 mm



∅40 mm

½

06-8286 550g
OMBREDANNE
240 mm



∅40 mm

½

06-8287
HEATH
copper filled head
700 g
185 mm

Tampers - Osteotomes, Chisels and Gouges

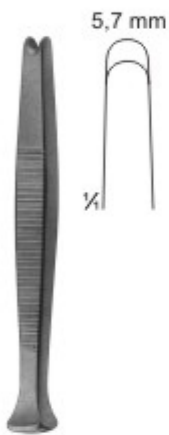

06-8288
HAASE
100 mm



06-8289 - 06-8290
PASSOW
120 mm



06-8291 - 06-8293
CASPAR
200 mm



06-8294 - 06-8296
200 mm

- **06-8291**
∅ 3 mm
- **06-8292**
∅ 5 mm
- **06-8293**
∅ 8 mm

- **06-8294**
∅ 12 mm
- **06-8295**
∅ 14 mm
- **06-8296**
∅ 16 mm



06-8297 4mm
FREER
Chisel
160 mm

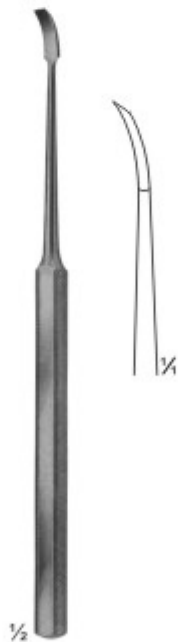

06-8298 4mm
FREER
Chisel, curved
160 mm



06-8299 6mm
FREER
Gouge
150 mm



06-8300 3.4mm
Scaphoid gouge,
downwards curved
135 mm

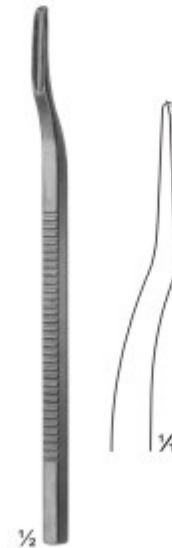

06-8301 3.4mm
Scaphoid gouge,
upwards curved
135 mm



06-8302 - 06-8304
MANNERFELT modif
Osteotomes
06-8302 4 mm
06-8303 6 mm
06-8304 8 mm
155 mm

Osteotomes Chisels and Gouges

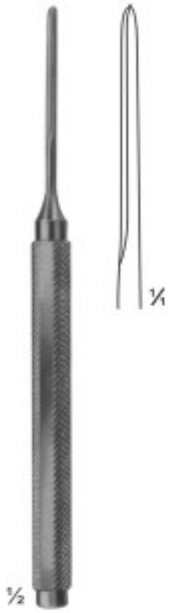

06-8305 3mm
MANNERFELT modif.
Gouge
155 mm

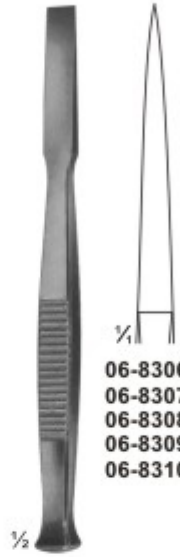

06-8306 - 06-8310
Osteotomes
140 mm

- 06-8306 4 mm
- 06-8307 6 mm
- 06-8308 8 mm
- 06-8309 10 mm
- 06-8310 12 mm

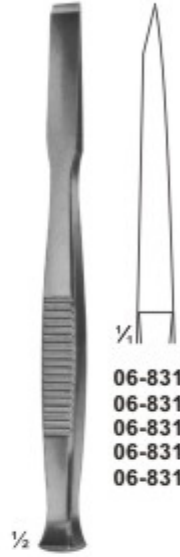

06-8311 - 06-8315
Chisels
140 mm

- 06-8311 4 mm
- 06-8312 6 mm
- 06-8313 8 mm
- 06-8314 10 mm
- 06-8315 12 mm

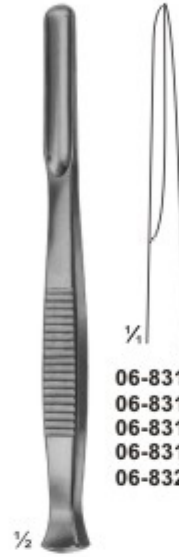

06-8316 - 06-8320
Gouges
140 mm

- 06-8316 4 mm
- 06-8317 6 mm
- 06-8318 8 mm
- 06-8319 10 mm
- 06-8320 12 mm

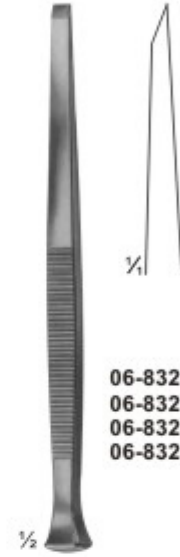

PARTSCH
06-8321 - 06-8324
Chisels
140 mm

- 06-8321 3 mm
- 06-8322 4 mm
- 06-8323 5 mm
- 06-8324 6 mm

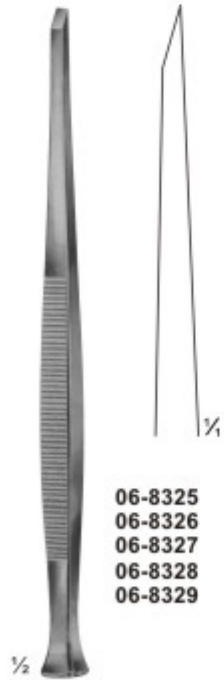

PARTSCH
06-8325 - 06-8329
Chisels
170 mm

- 06-8325 3 mm
- 06-8326 4 mm
- 06-8327 5 mm
- 06-8328 6 mm
- 06-8329 7 mm

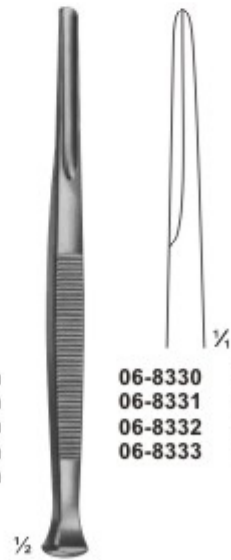

PARTSCH
06-8330 - 06-8333
Gouges
140 mm

- 06-8330 3 mm
- 06-8331 4 mm
- 06-8332 5 mm
- 06-8333 6 mm

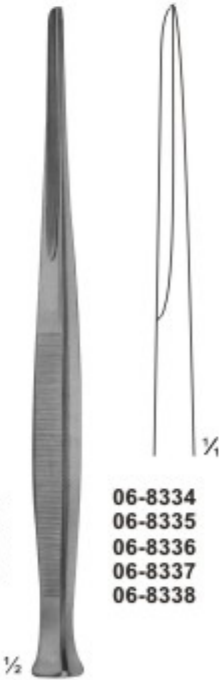

PARTSCH
06-8334 - 06-8338
Gouges
170 mm

- 06-8334 3 mm
- 06-8335 4 mm
- 06-8336 5 mm
- 06-8337 6 mm
- 06-8338 7 mm



LUCAS
06-8339 - 06-8340
Chisels
160 mm

- 06-8339 4 mm
- 06-8340 6 mm



LUCAS
06-8341 - 06-8342
Gouges
160 mm

- 06-8341 3 mm
- 06-8342 5 mm

Osteotomes Chisels and Gouges



ALEXANDER
06-8343 - 06-8346
Gouges
170 mm

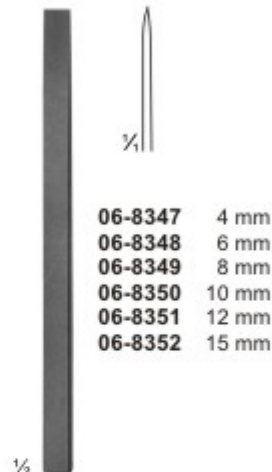

LAMBOTTE
06-8347 - 06-8352
Osteotomes
125 mm

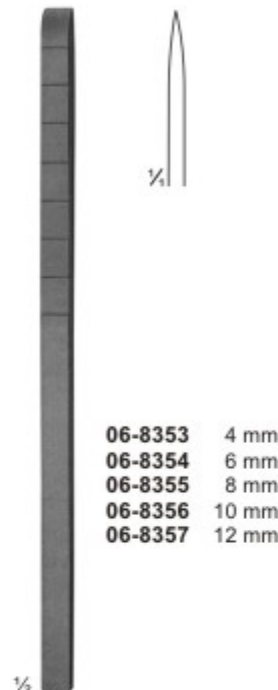

COTTLE
06-8353 - 06-8357
Osteotomes with depth
markings
180 mm

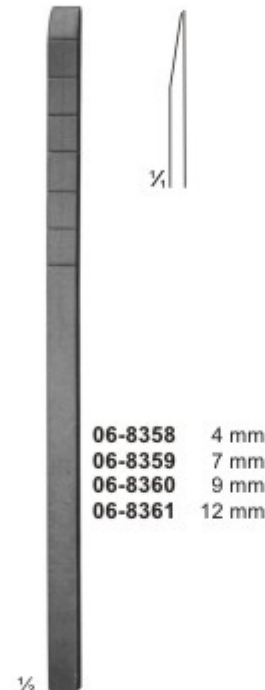

COTTLE
06-8358 - 06-8361
Chisel-Osteotomes
with depth markings
180 mm

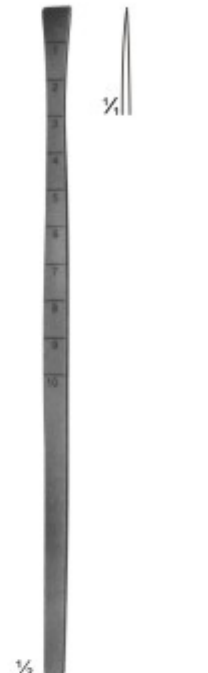

COTTLE
06-8362 8mm
Fishtail Chisel,
with protected ends
180 mm

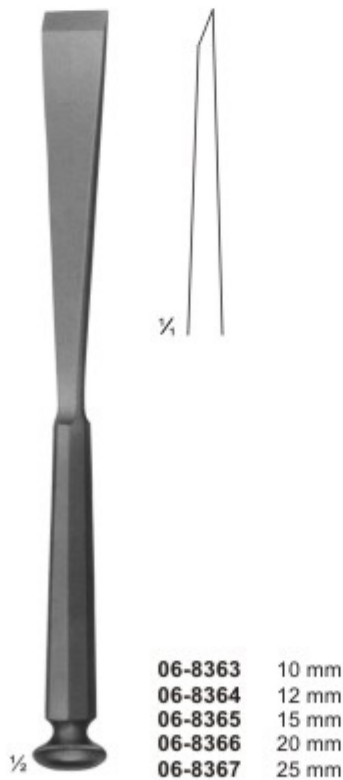

STILLE
06-8363 - 06-8367
Chisels
205 mm

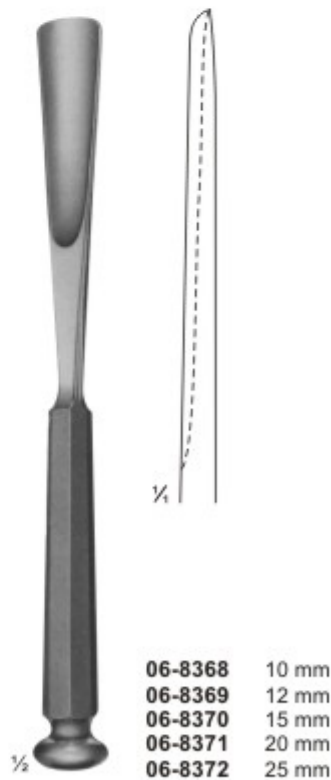

STILLE
06-8368 - 06-8372
Gouges
205 mm

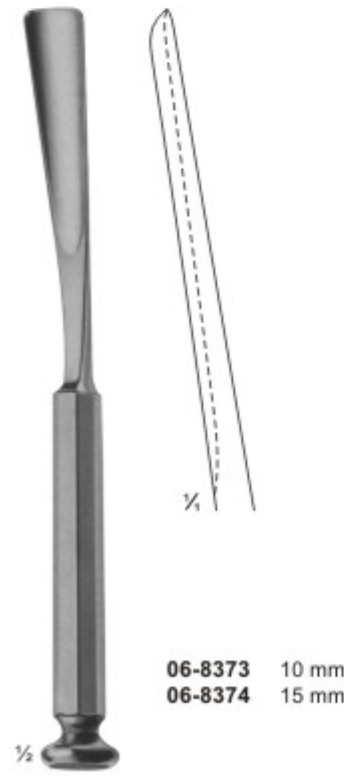

WALTER
06-8373 - 06-8374
gouges for taking
grafts from the ribs
205 mm

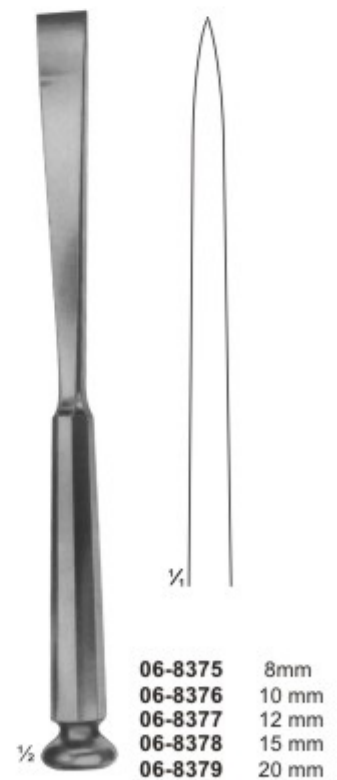













STILLE
06-8375 - 06-8380
Osteotomes
205 mm

Osteotomes



<p>1/2</p> <p>06-8381 10 mm 06-8382 12 mm 06-8383 15 mm 06-8384 20 mm 06-8385 25 mm</p>	<p>1/2</p> <p>06-8386 10 mm 06-8387 12 mm 06-8388 15 mm 06-8389 20 mm 06-8390 25 mm</p>	<p>1/2</p> <p>06-8391 4 mm 06-8392 8 mm 06-8393 10 mm 06-8394 13 mm 06-8395 15 mm 06-8396 18 mm 06-8397 20 mm 06-8398 25 mm 06-8399 30 mm 06-8400 38 mm 06-8401 44 mm 06-8402 50 mm</p>	<p>1/2</p> <p>06-8403 8 mm 06-8404 13 mm 06-8405 18 mm 06-8406 25 mm 06-8407 30 mm 06-8408 38 mm</p>
<p>STILLE 06-8381 - 06-8385 Osteotomes 205 mm</p>	<p>STILLE 06-8386 - 06-8390 Osteotomes, curved 205 mm</p>	<p>LAMBOTTE 06-8391 - 06-8402 Osteotomes 245 mm</p>	<p>LAMBOTTE 06-8403 - 06-8408 Osteotomes, curved 245 mm</p>

Osteotomes, Chisels and Gouges with HARTPRESS -handle

 	<p>06-8409 4 mm 06-8410 6 mm 06-8411 8 mm 06-8412 10 mm 06-8413 12 mm</p>	 	<p>06-8414 4 mm 06-8415 6 mm 06-8416 8 mm 06-8417 10 mm 06-8418 12 mm</p>	 	<p>06-8419 5 mm 06-8420 7 mm 06-8421 10 mm 06-8422 15 mm 06-8423 20 mm 06-8424 25 mm 06-8425 30 mm</p>
<p>LEXER-MINI 06-8409 - 06-8413 Osteotomes 180 mm</p>	<p>LEXER-MINI 06-8414 - 06-8418 Gouges 180 mm</p>	<p>LEXER 06-8419 - 06-8425 Gouges 220 mm</p>			
 	<p>06-8426 5 mm 06-8427 7 mm 06-8428 10 mm 06-8429 15 mm 06-8430 20 mm 06-8431 25 mm 06-8432 30 mm</p>	 	<p>06-8433 9mm Gouge for removing broken screws 220 mm</p>	 	<p>06-8434 5,5 mm 06-8435 9,0 mm</p>
<p>LEXER 06-8426 - 06-8432 Osteotomes 220 mm</p>			<p>ZIELKE 06-8434 - 06-8435 Gouges for scoliosis-operations 230 mm</p>		

Osteotomes ,Chisels and Gouges with HARTPRESS -handle

Can be sterilized in a stream sterilizer upto 3 bar over pressure (143 °C).



Reposition Forceps



06-8442
Reposition forceps,
for small fragments
135 mm



06-8443
HAASE
Reposition forceps,
for mandibular
fractures
165 mm

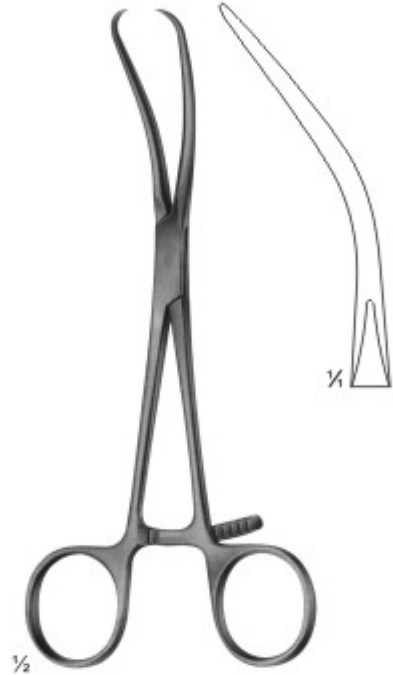

06-8444
REILL
Reposition forceps,
170 mm



06-8445
Reposition forceps
205 mm

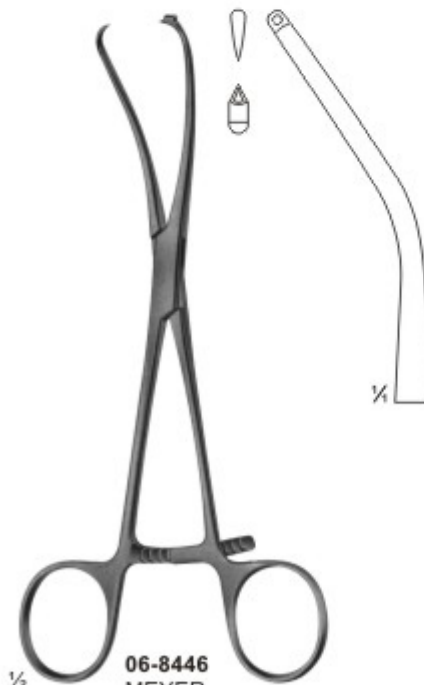

06-8446
MEYER
Reposition forceps
for fingers, with drill
guide for KIRSCHNER
wires up to diam. 1.0 mm
170 mm

Reposition Forceps, Bone Holding Forceps



06-8447
Patella forceps
185 mm



06-8448
Forceps with
ratchet fixation
140 mm



06-8449
Forceps with
thread fixation
170 mm



06-8450
Forceps with
thread fixation
235 mm

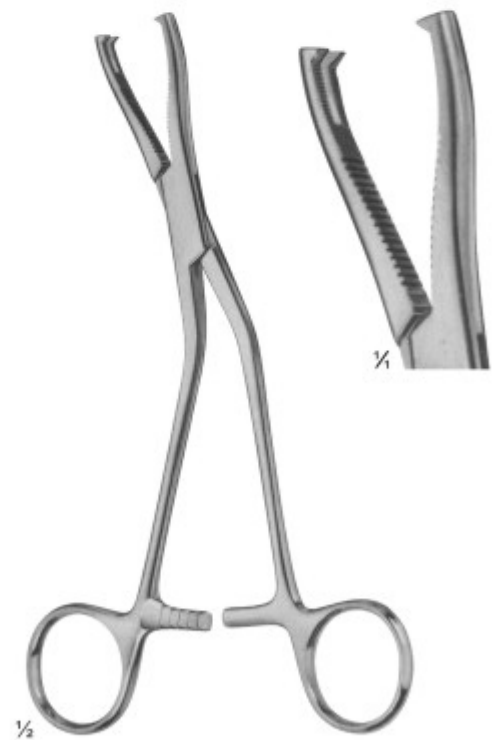

06-8451
DINGMANN modif
185 mm

Bone Holding Forceps



06-8452
Sequestrum
forceps
200 mm



06-8453
VAN BUREN
Sequestrum
forceps
225 mm



06-8454
LANGENBECK
205 mm



06-8455
FERGUSSON
205 mm

Bone Holding Forceps

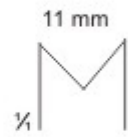
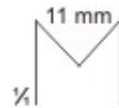
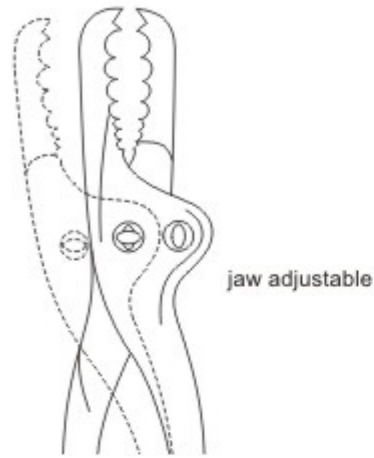

8 mm



06-8456
SEMB
190 mm



06-8457
FARABEUFF
230 mm



06-8458
FARABEUFF
255 mm



06-8459
FARABEUFF-LAMBOTTE
255 mm

Bone Holding Forceps

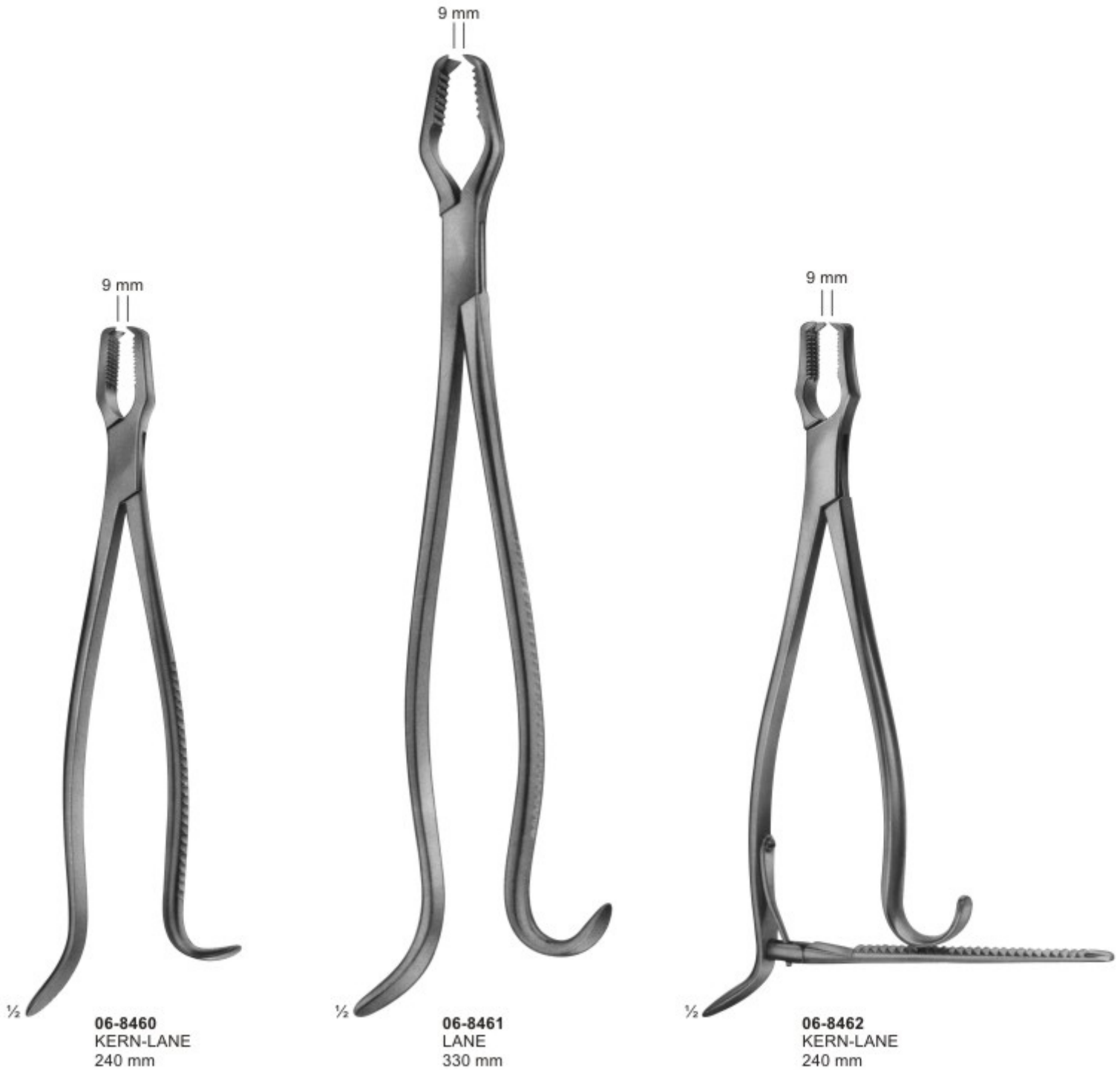

Bone Holding Forceps



06-8463
LANE
320 mm



06-8464
HEY GROVES
305 mm

Bone Holding Forceps

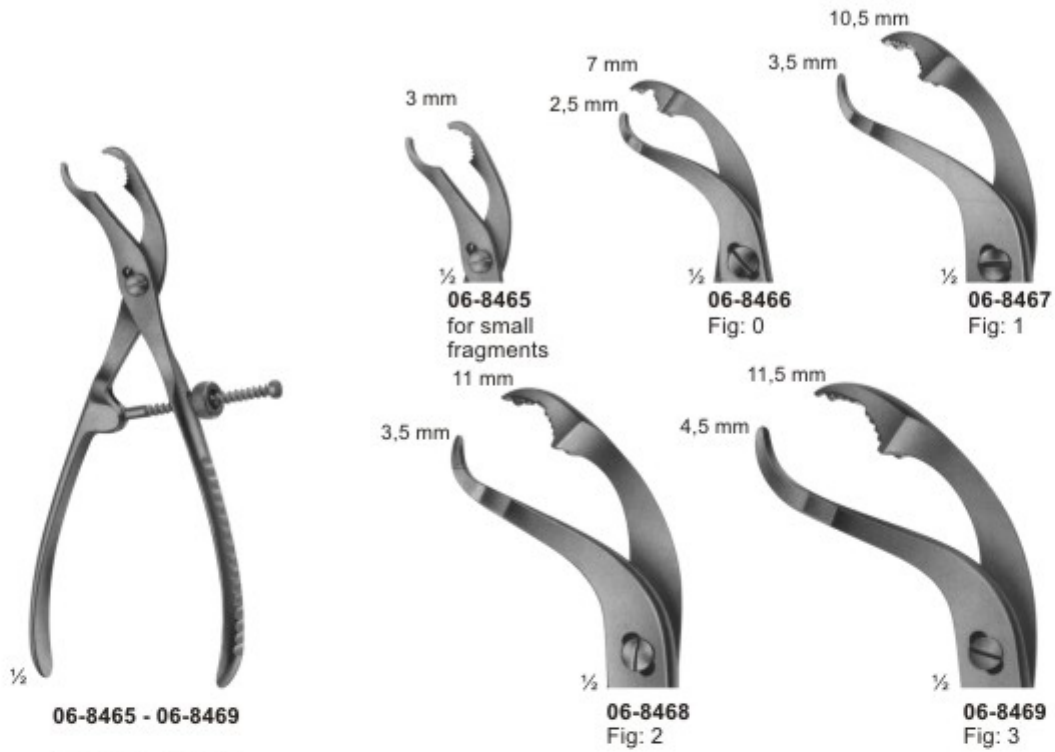

- 06-8465 145 mm
- 06-8466 190 mm
- 06-8467 240 mm
- 06-8468 260 mm
- 06-8469 280 mm

Self-centering forceps with thread fixation

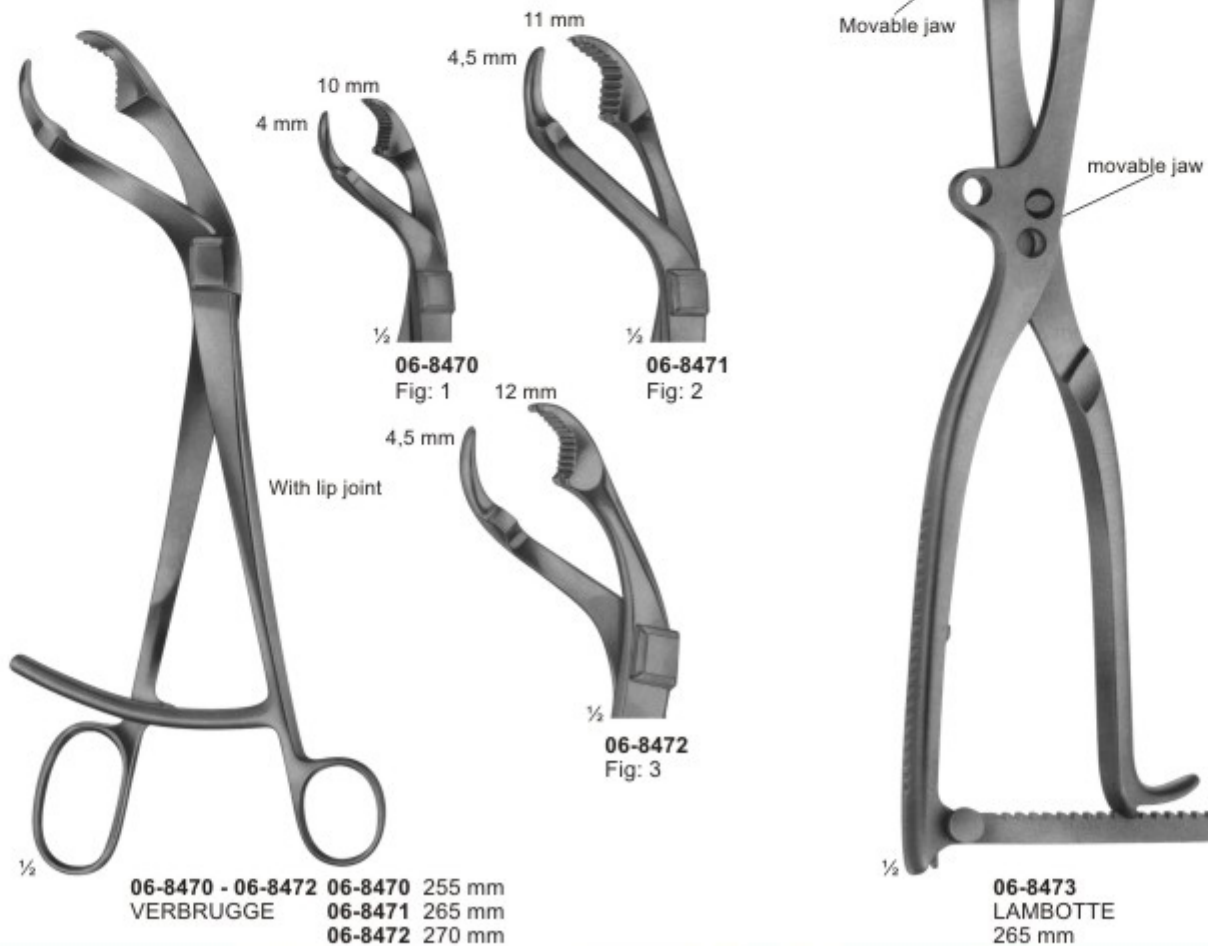

Bone Clamps



$\frac{1}{2}$
06-8474 - 06-8475
LOWMAN
06-8474 170 mm
06-8475 205 mm



$\frac{1}{2}$
06-8476
LOWMAN-GERSTER
210 mm



$\frac{1}{2}$
06-8477
LOWMAN-HOGLUND
175 mm

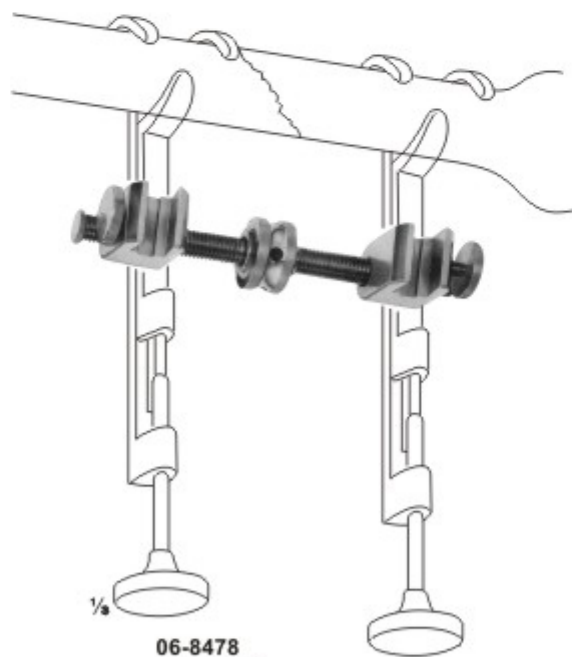

$\frac{1}{2}$
06-8478
GERSTER
Traction bar for **06-8474 - 06-8477**

Synovectomy-Rongeurs, Bone Rongeurs



06-8479 - 06-8480
Synovectomy rongeur
width of jaws 1.2 mm
130 mm



06-8481 - 06-8482
Synovectomy rongeur
width of jaws 2.0 mm
130 mm



06-8483
STELLBRINK
Synovectomy rongeur
175 mm



06-8484
STELLBRINK
Synovectomy rongeur
170 mm



06-8485
LUER-FRIEDMANN
145 mm



06-8486
140 mm

Bone Rongeurs



06-8487
LUER
150 mm



06-8488
LUER
155 mm



06-8489
BLUMENTHAL
155 mm



06-8490
BLUMENTHAL
150 mm



06-8491 - 06-8492
JANSEN
175 mm

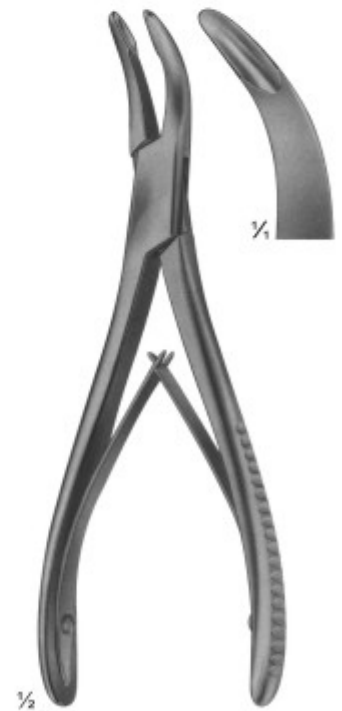

06-8493
BANE-HARTMANN
175 mm

Bone Rongeurs



06-8494
ALEXANDER
140 mm

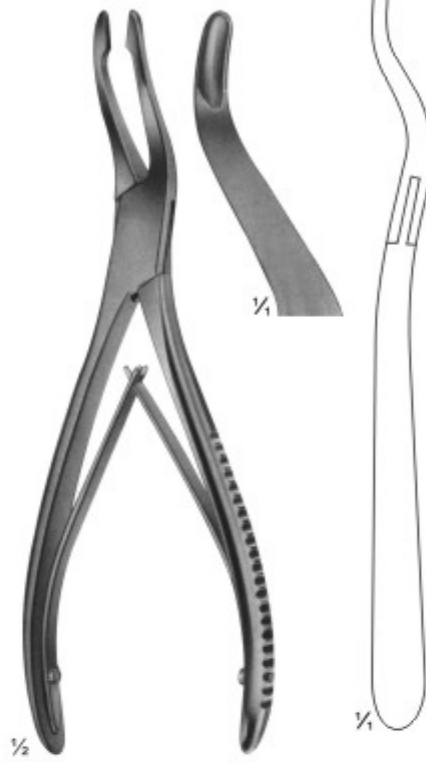

06-8495
JANSEN
190 mm

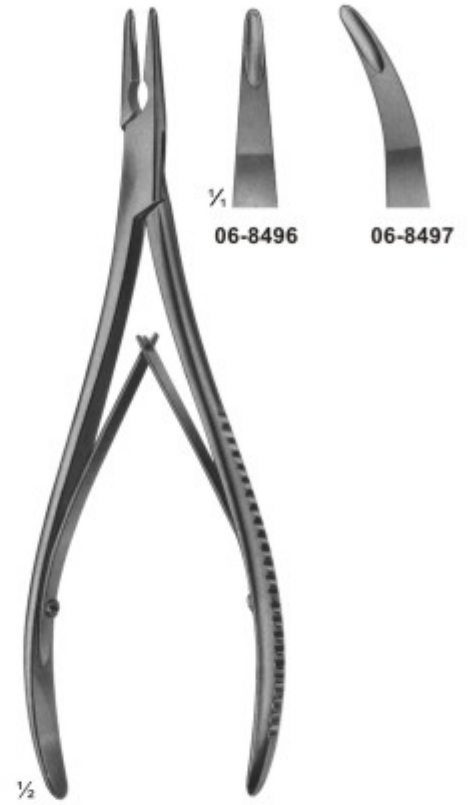

06-8496 - 06-8497
LEMPERT
200 mm

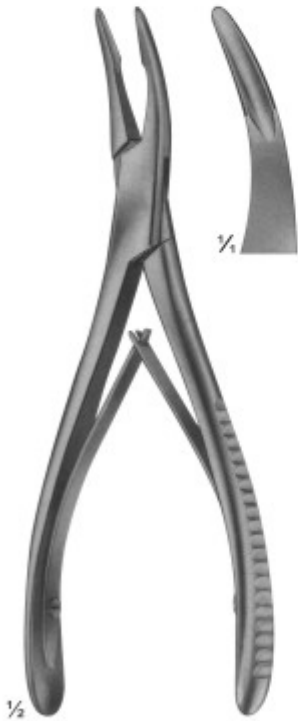

06-8498
BEYER
180 mm

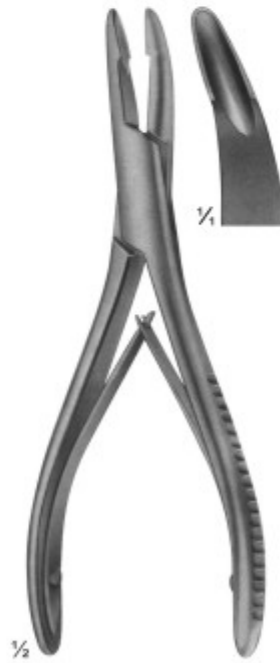

06-8499
MEAD
165 mm

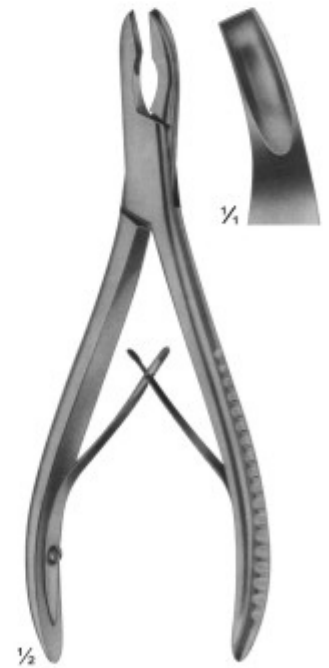

06-8500
MEAD
165 mm

Bone Rongeurs

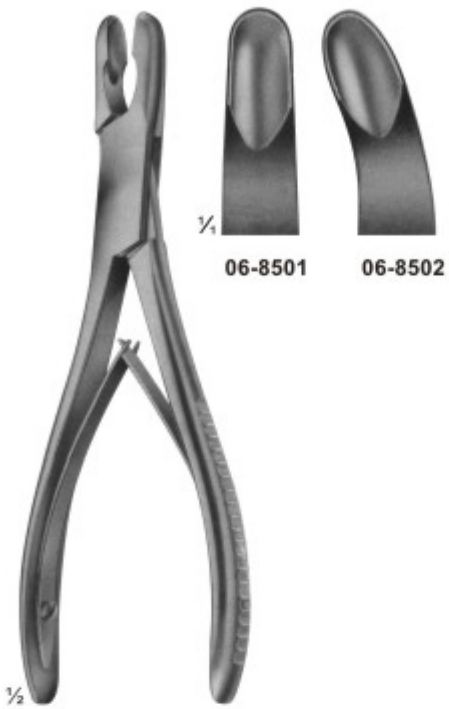

06-8501 06-8502

06-8501 - 06-8502
LUER
175 mm



06-8503
LUER
180 mm

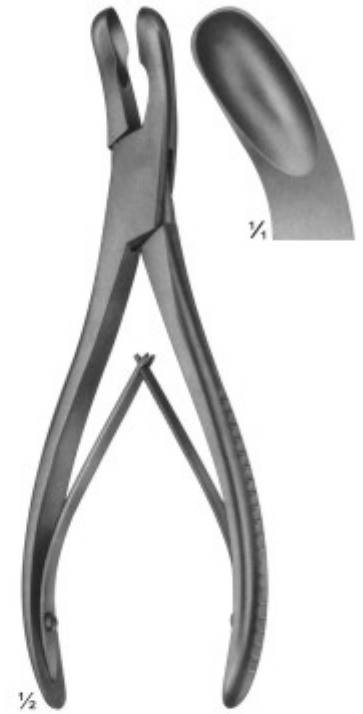

06-8504
LUER
180 mm

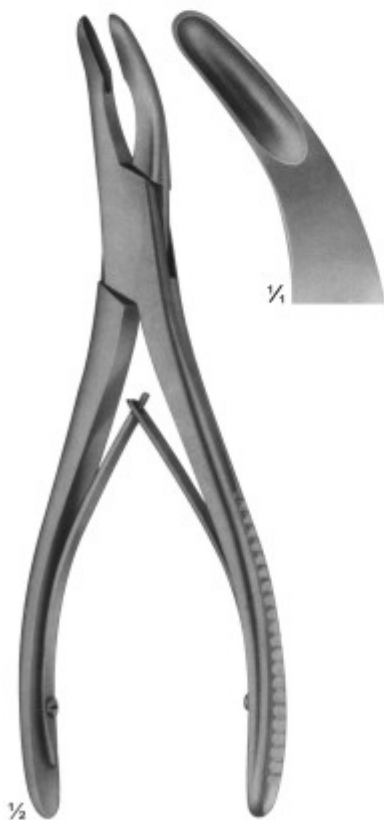

06-8505
OLIVECRONA
205 mm



06-8506 - 06-8507
BOHLER
155 mm



06-8508
MARQUARDT
200 mm

Bone Rongeurs



06-8509
RUSKIN
190 mm



06-8510
ROETTGEN-RUSKIN
240 mm



06-8511 - 06-8512
ECHLIN
230 mm

Bone Rongeurs



06-8513
STILLE
235 mm



06-8514
LEKSELL-STILLE
240mm



06-8515
STILLE-RUSKIN
240mm

Bone Rongeurs



06-8516
LUER-STILLE
225 mm



06-8517
LUER-STILLE
225 mm

Bone Rongeurs



06-8518
LUER-STILLE
270 mm



06-8519
SEMB
240 mm

Bone Cutting Forceps



06-8520
STAMM
150 mm



06-8521
KAZANJIAN
185 mm



06-8522
140 mm



06-8523
170 mm



06-8526
170 mm

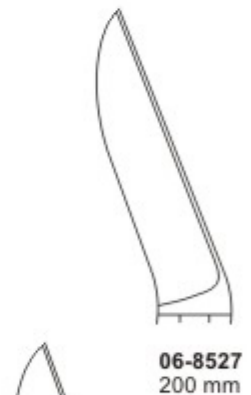

06-8527
200 mm

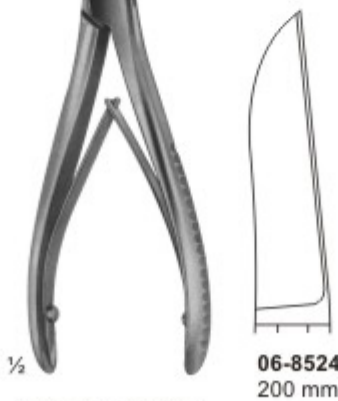

06-8524
200 mm



06-8525
220 mm



06-8526 - 06-8528
LISTON



06-8528
220 mm

Bone Cutting Forceps



06-8529
BOEHLER
145 mm



06-8530
RUSKIN-LISTON
190 mm



06-8531
RUSKIN-LISTON
190 mm

Bone Cutting Forceps

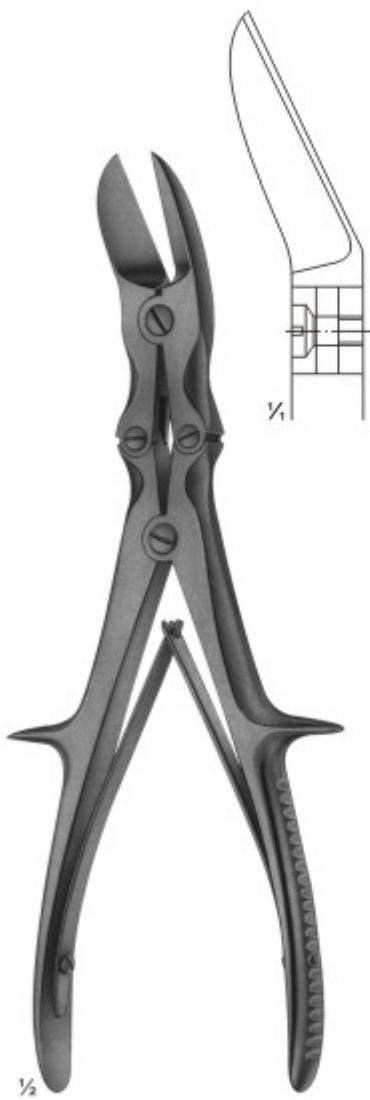

06-8532
LISTON
curved on flat
240 mm

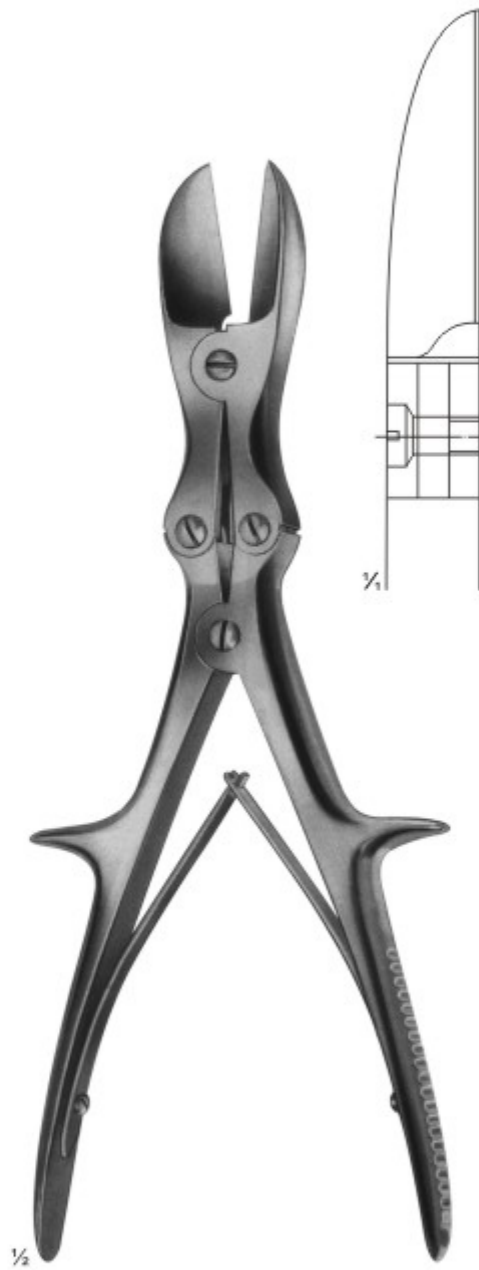

06-8533
LISTON
straight
280 mm

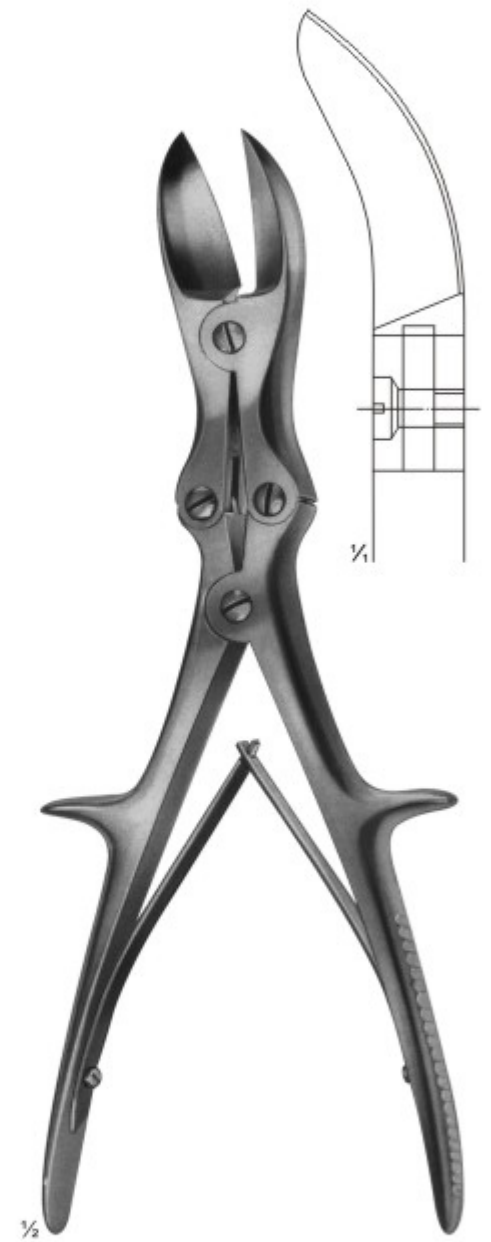

06-8534
LISTON
curved on flat
280 mm

Bone Cutting Forceps

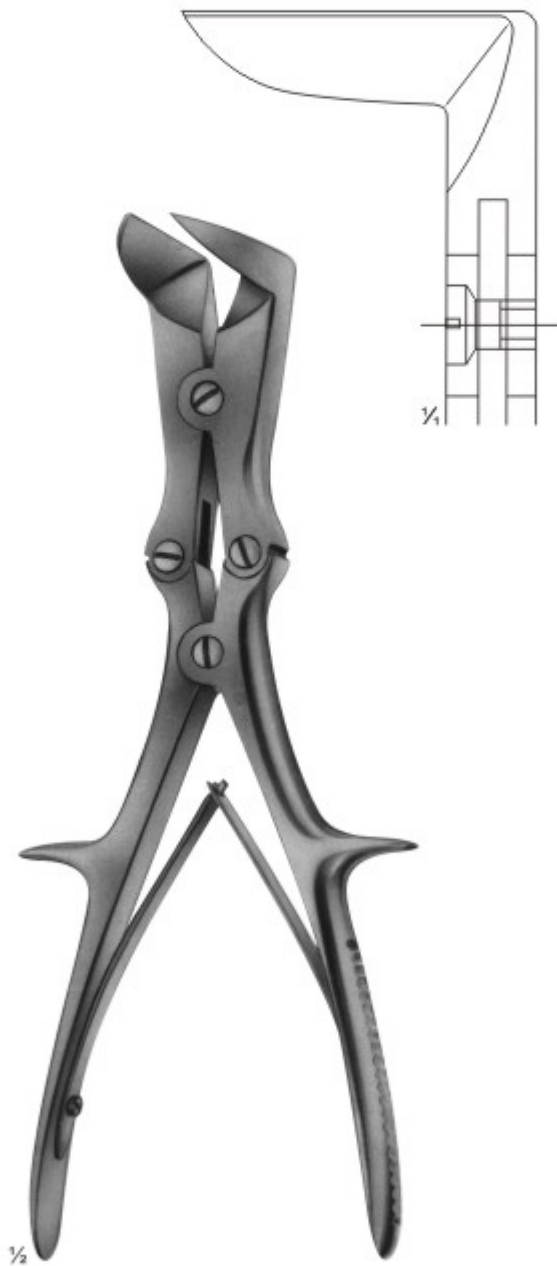

06-8535
LISTON-STILLE
265 mm

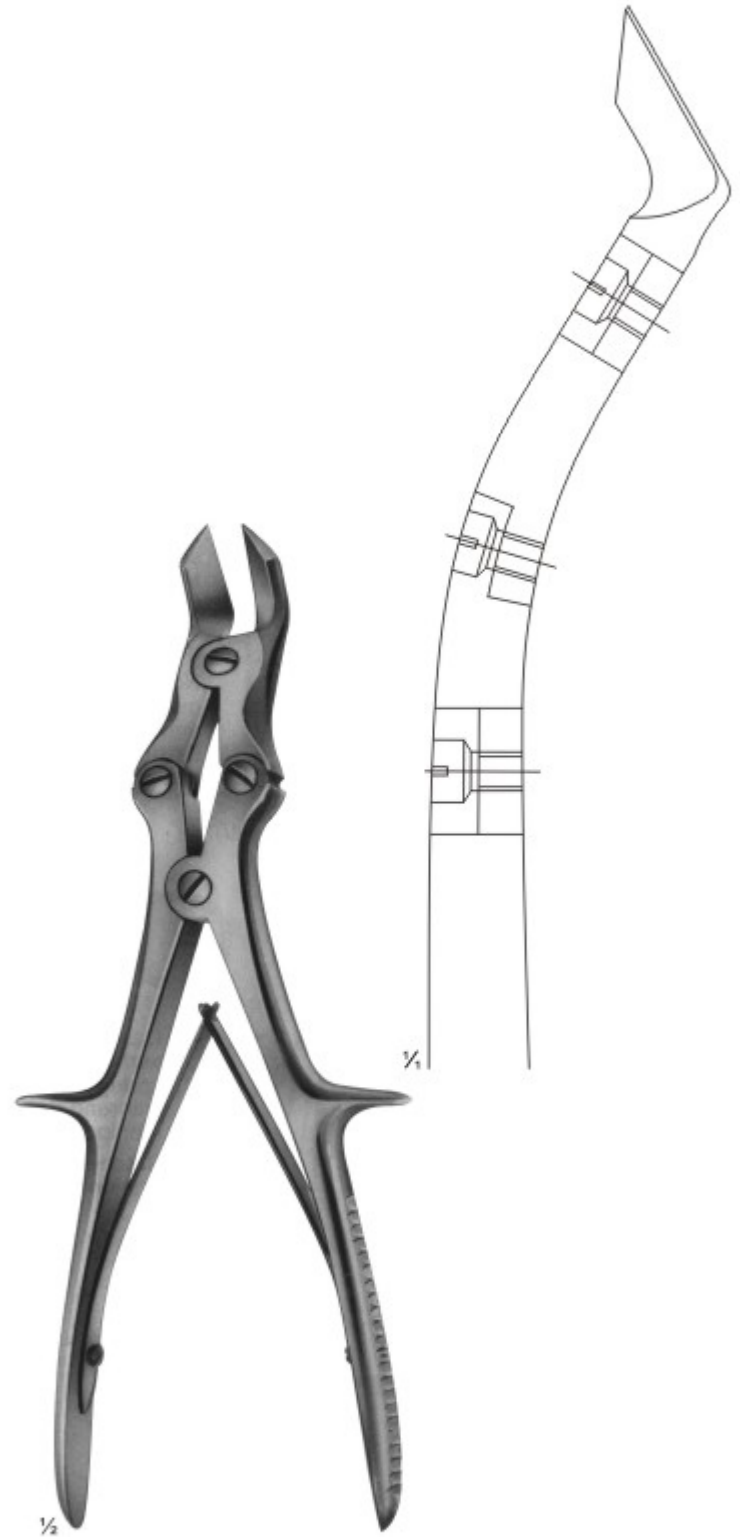

06-8536
LISTON-KEY-HORSLEY
(TUDOR EDWARDS)
255 mm

Meniscus-and Cartilage Forceps

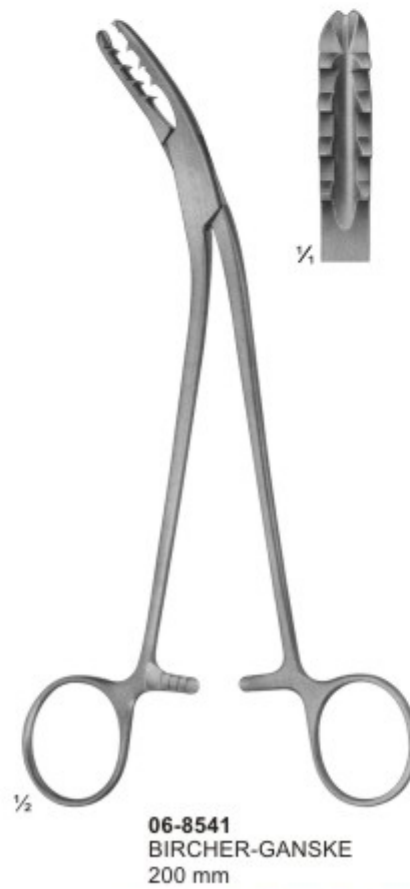
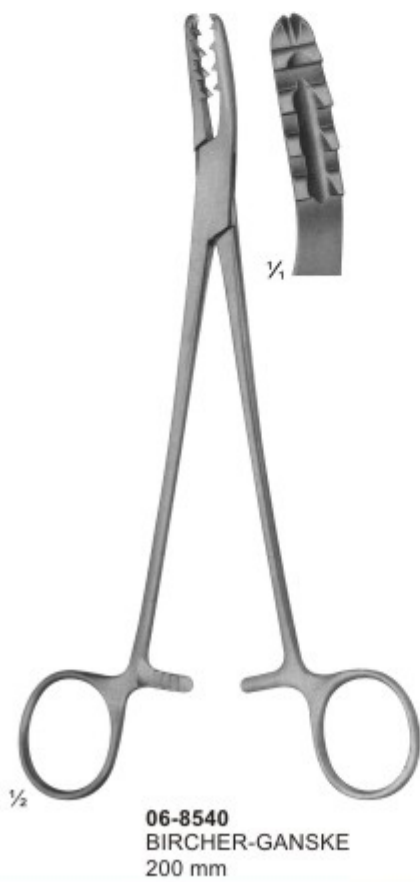
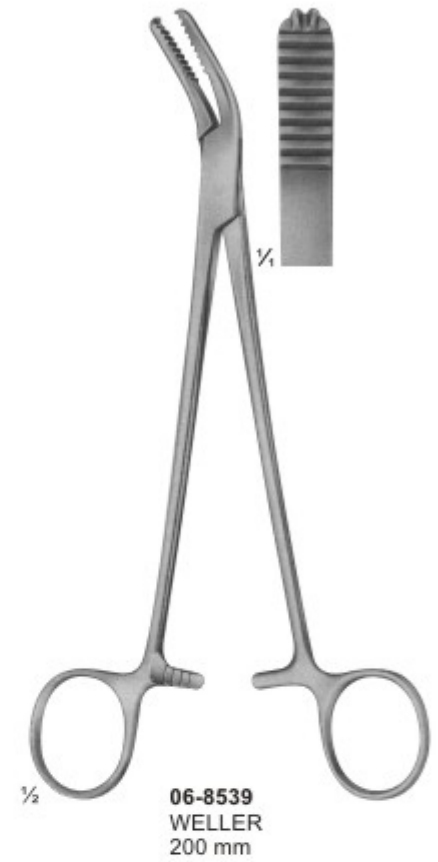

Meniscus Knives

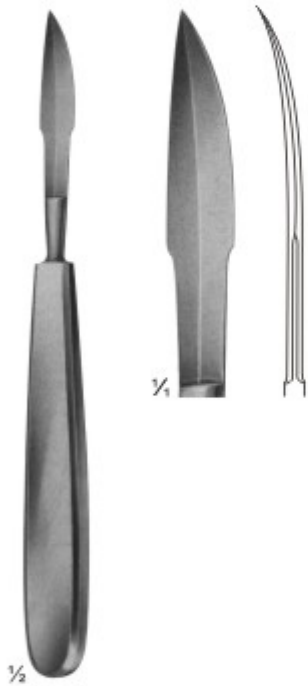

06-8543
170 mm



06-8544
NEFF
215 mm



06-8545
NEFF
215 mm



06-8546
WAGNER
215 mm

Meniscus Knives

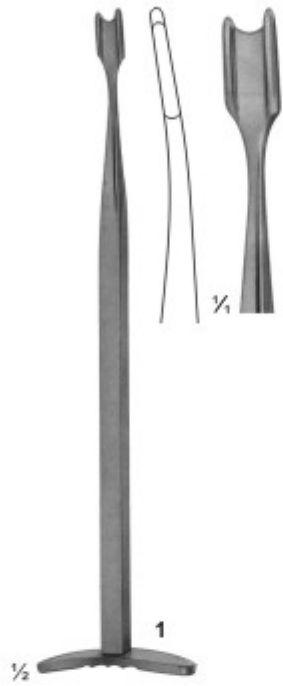

06-8547
SMILLIE
170 mm

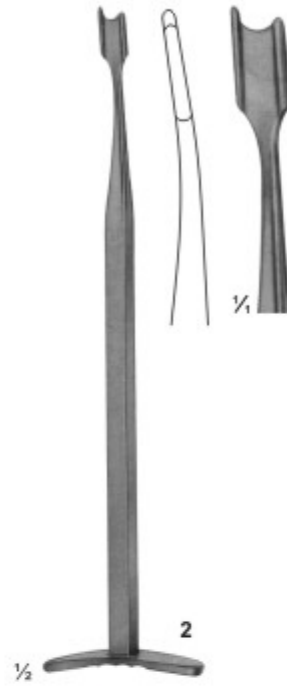

06-8548
SMILLIE
170 mm

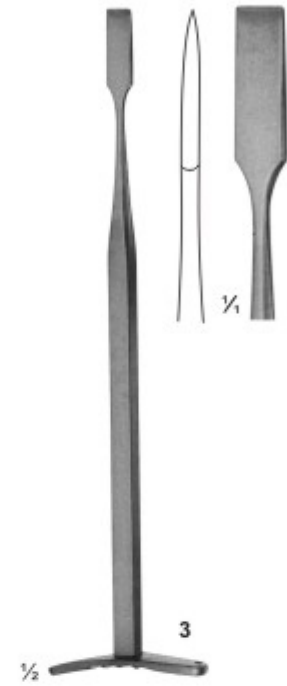

06-8549
SMILLIE
170 mm

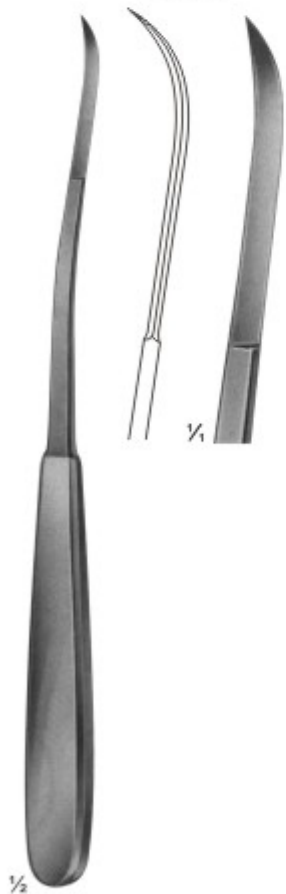

06-8550
SALENIUS
220 mm

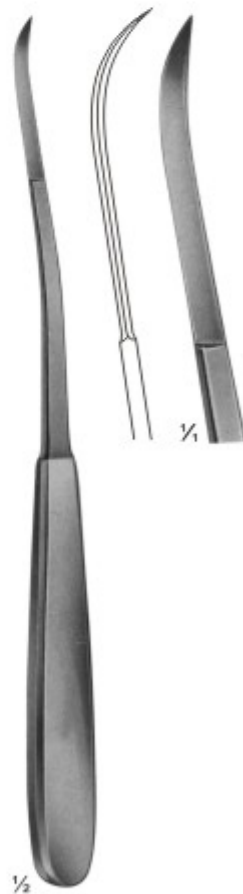

06-8551
SALENIUS
220 mm



06-8552
CANAD. MODELL
200 mm

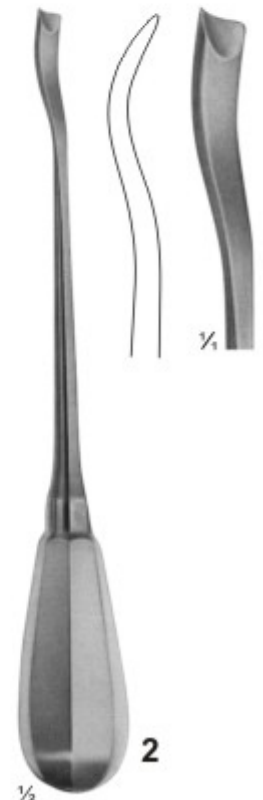

06-8553
CANAD. MODELL
200 mm

Wire Extension

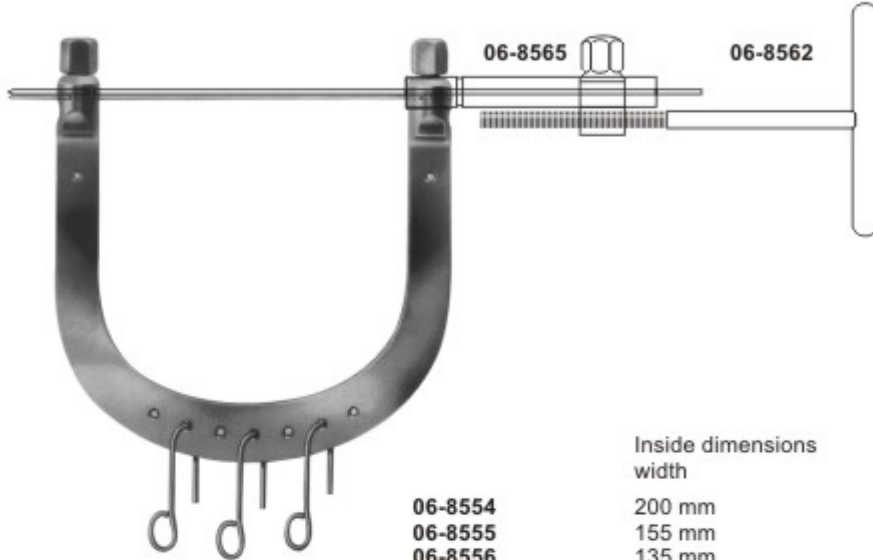

06-8554 - 06-8560
KIRSCHNER
 Wire traction bows,
 to be used with
 KIRSCHNER-wires
 up to 2.5 mm diam.,
 With 3 hooks,
 stainless steel

	Inside dimensions width	depth	
06-8554	200 mm	155 mm	for the hip
06-8555	155 mm	155 mm	for the femur
06-8556	135 mm	130 mm	for the knee
06-8557	120 mm	120 mm	for the knee
06-8558	105 mm	100 mm	for the knee
06-8559	95 mm	110 mm	for the calcaneus
06-8560	95 mm	70 mm	for the arm and elbow



06-8561
 Wrench, double - ended,
 for wire traction bows



06-8562
 Wire tightener, with
 clamping jaws



06-8563
 Traction hook only,
 large size



06-8564
 Traction hook only,
 small size



06-8565
 Fixation clamp, to secure clamping
 jaws of **06-8562** stainless steel

Wire Extension

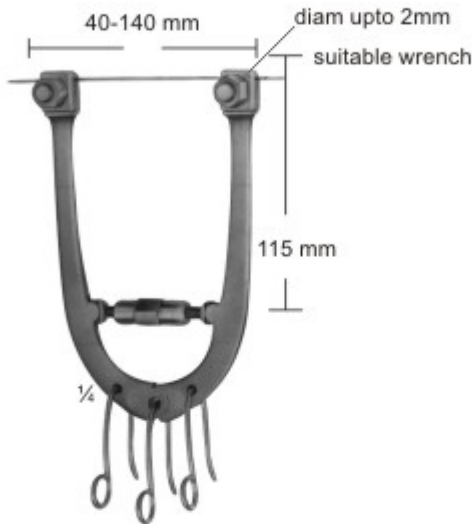

06-8566
Wire traction bow, adjustable,
with 3 hooks, small size

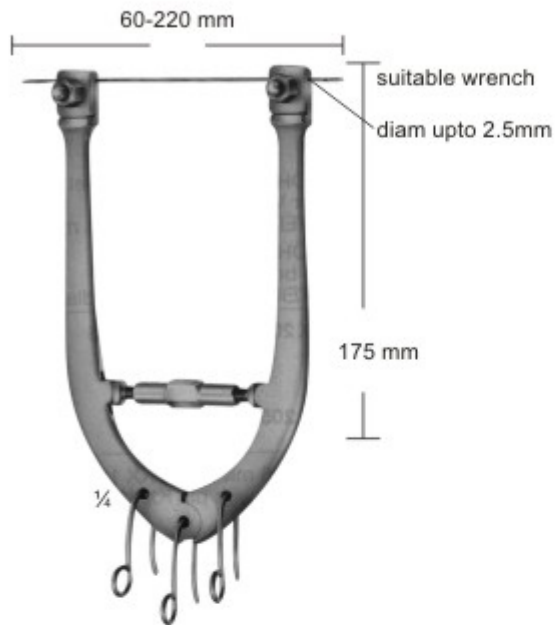

06-8567
Wire traction bow, adjustable,
with 3 hooks, large size

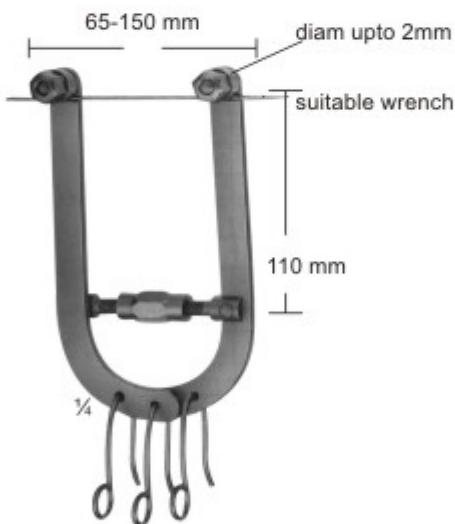

06-8568
Wire traction bow, adjustable,
with 3 hooks, small size for
elbow and calcaneus, for
adolescents



06-8569 max. 105 mm
06-8570 max. 160 mm
06-8571 max. 200 mm

06-8569 80-95 mm
06-8570 90-120 mm
06-8571 140-170 mm

diam upto
06-8569 1,6 mm
06-8570 2,0 mm
06-8571 2,5 mm

06-8569 - 06-8571
KIRSCHNER
Wire traction bows, modified,
adjustable in width, holds wire
securely, with 1 hook

06-8572
Fixation disc, slotted



06-8573
idem, aluminum, transparent
to X-rays



06-8574
Fixation disc, slotted



06-8575
Screw driver, for above
fixations discs



Traction Bows, Distractor

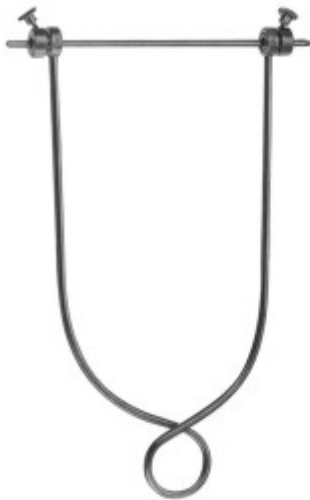

Boehler traction bows, to be used with STEINMANN pins, 4mm diam	Boehler traction bows, to be used with STEINMANN pins, 5mm diam	Inside width	For
06-8576 with pin (09-8588)		16x9cm	Arm
06-8577 without pin	06-8582 without pin		
06-8578 with pin (09-8590)		21x11cm	Femur and knee
06-8579 without pin	06-8583 without pin		
06-8580 with pin (09-8592)		21x15cm	Femur and knee
06-8581 without pin			



06-8584 - 06-8598
STEINMANN
triangular shaft ended and trocar point

diam \varnothing	4,0 mm	5,0 mm
Length		
80 mm	06-8584	
100 mm	06-8585	
120 mm	06-8586	
140 mm	06-8587	
150 mm	06-8588	06-8594
160 mm	06-8589	
180 mm	06-8590	06-8595
200 mm	06-8591	06-8596
210 mm	06-8592	
250 mm	06-8593	06-8597
300 mm		06-8598



06-8599
SCHWARZ
Traction bow for fingers,
to be used with KIRSCHNER-
wire up to 1.6 mm diam.



06-8600
Small distractor
as a repositioning device for
distraction and compression of small bones,
for wires with 3.0 mm diam.



06-8601
Protection cap
for 4,0 mm STEINMANN Pins



06-8602
Protection cap
for 5,0 mm STEINMANN Pins

Drilling Chucks and Cerclage Wire Tightener



1/2

06-8603
REILL
Drilling chuck, cannulated, for shanks from 2.0 - 2.5 mm diam 115 mm



1/2

06-8604
Drilling chuck, cannulated, for shanks from 0.8 - 2.0 mm diam 150 mm



1/2

06-8605
Drilling chuck, cannulated, for shanks up to 4.5 mm diam with key 140 mm



1/2

Movable tip made of (material used for implants). While twisting the movable head remains stable, therefore the wire will not slip off.

06-8606
LOUTE
Wire tightener, improved pattern, with movable tip, for wires up to 1.0 mm diam. 220 mm

Chuck jaws made of material used for implants



1/2

06-8607
Drilling chuck, cannulated, for shanks up to 6.35 mm diam., To be tightened by hand 100 mm



1/2

06-8608
Drilling chuck, cannulated, for shanks up to 4.5 mm diam., And for triangular shaft width across flats 4.7 mm (schanz screws, steinmann pins). with key **06-8609**



1/2

06-8610
Drilling chuck, cannulated, for shanks up to 6.35 mm diam., With key (**06-8611**) 160 mm

Cerclage Instruments

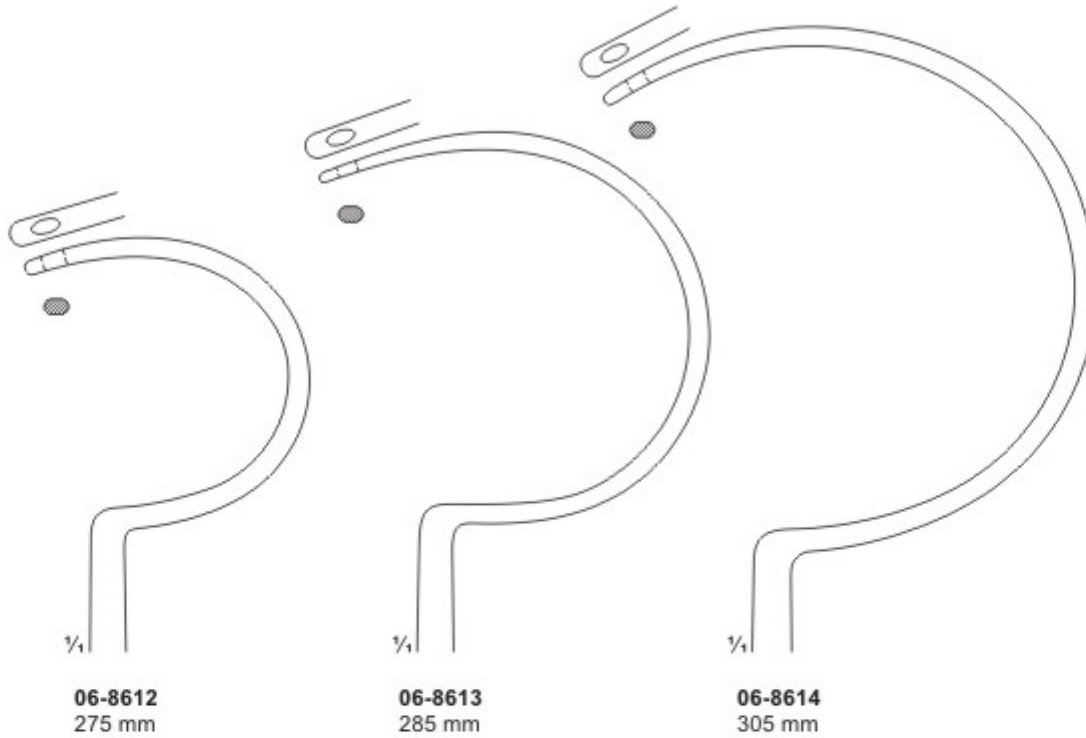

06-8612 - 06-8614
DEMEL
Wire guides

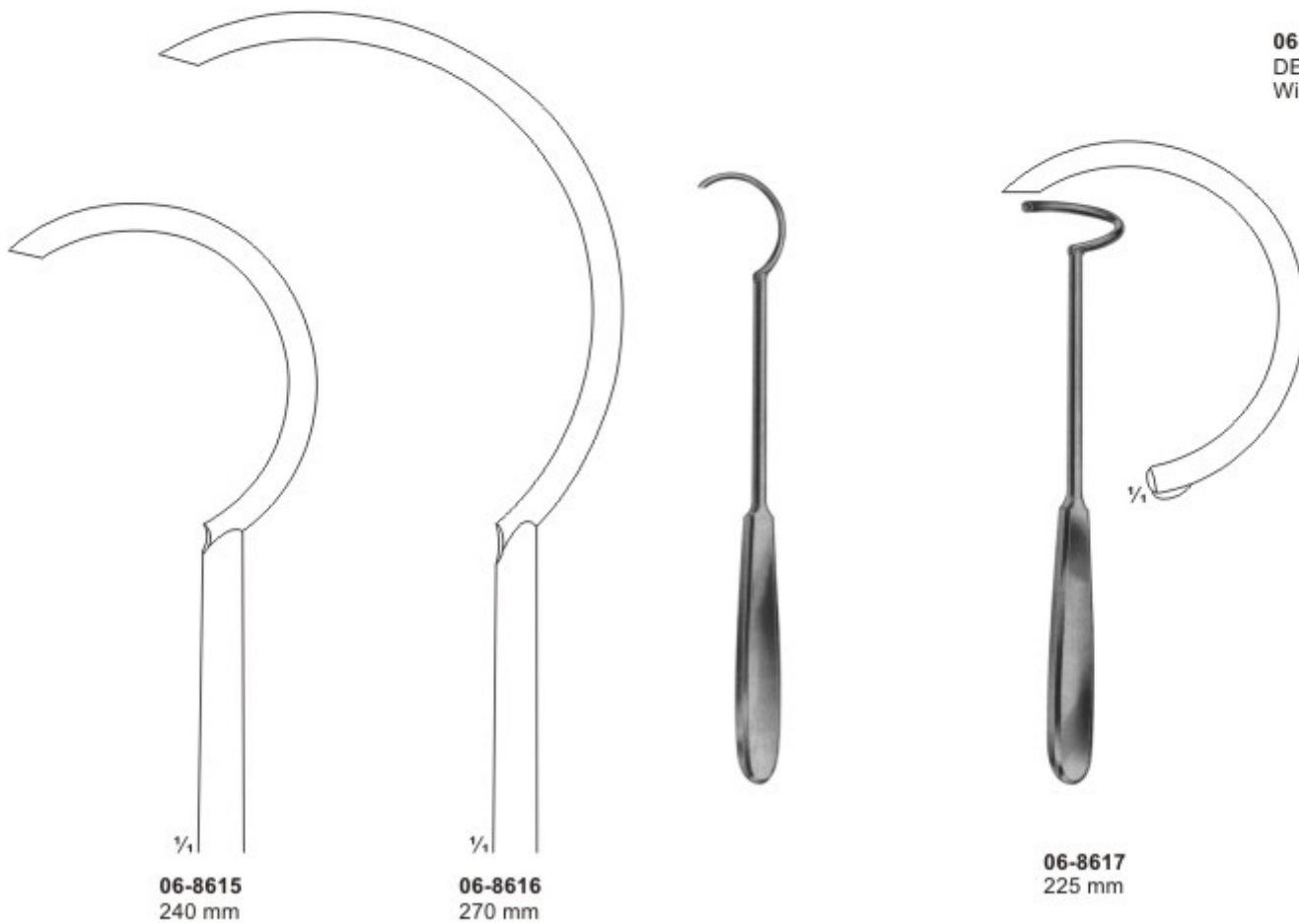

JORDAN instruments for subcutaneous Tibia Cerclage

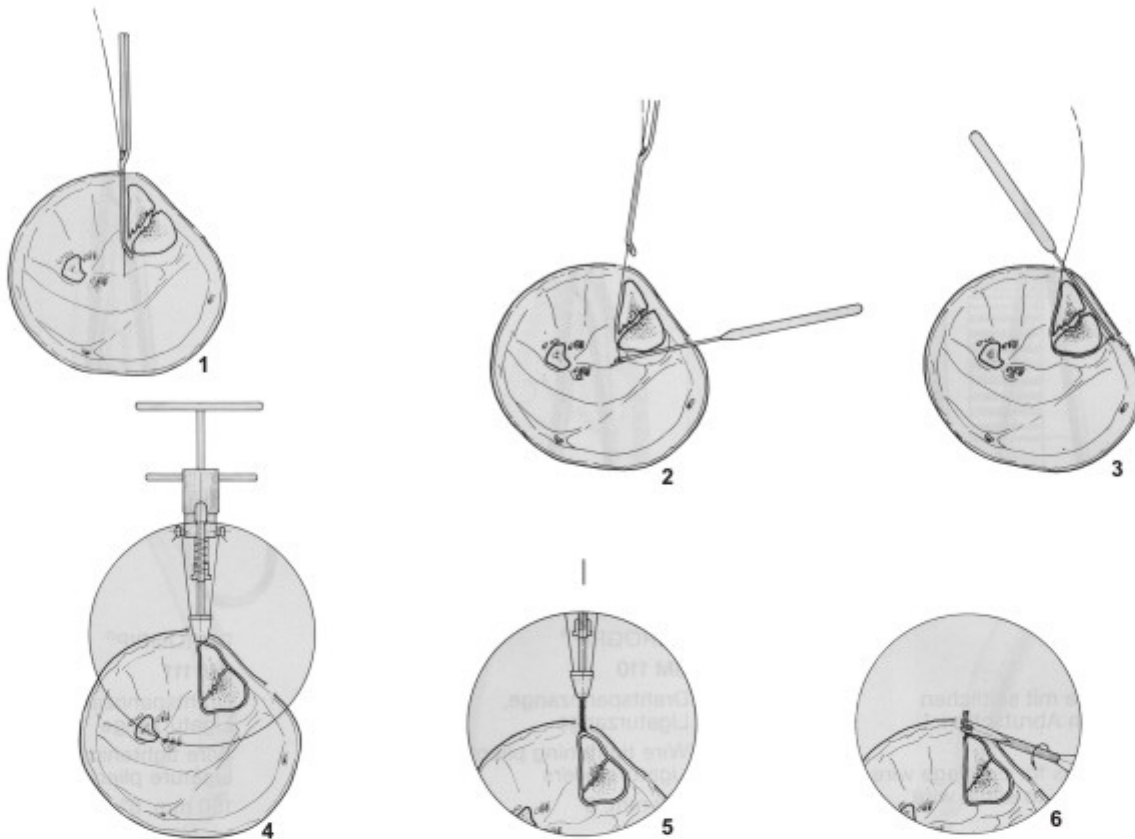

06-8618
JORDAN
Wire tightener



06-8619
JORDAN
Wire twister
170 mm



06-8620
JORDAN
Wire catcher
180 mm



06-8621
JORDAN
Probe, cannulated
170 mm

Wire Holding forceps, Wire Tightening Pliers, Flat-nosed Pliers DUROGRIP with Hard Metal Inserts



06-8622
DUROGRIP
Holding forceps for cerclage wire, with lateral jaws to avoid wire slipping off
170 mm



06-8623
DUROGRIP
Wire, tightening pliers, Ligature pliers
150 mm



06-8624
DUROGRIP
Wire, tightening pliers, Ligature pliers
150 mm



06-8625
with serrated jaws
140 mm



06-8626
one jaw smooth, one jaw serrated
140 mm



06-8627
with serrated jaws
06-8628
with longitudinal and transversal grooves
170 mm



06-8629
190 mm

Wire Holding forceps, Flat-nosed Pliers, Pliers for bending and cutting wires



06-8630
130 mm

06-8631
180 mm



06-8630 - 06-8631
Extraction pliers
for boring wires



06-8632
Flat-nosed pliers,
parallel
185 mm

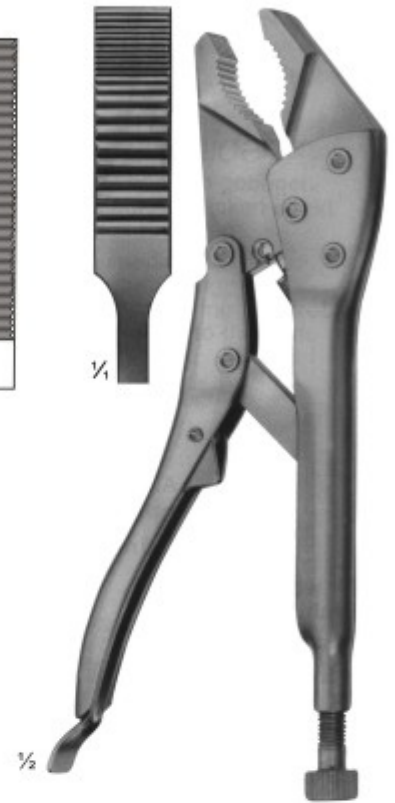

06-8633
Vise grip
200 mm



06-8634
Round Pliers
180mm



06-8634



06-8634



06-8635



06-8636



06-8637

06-8635 145 mm
06-8636 180 mm
06-8637 180 mm
Extraction pliers for wires



06-8638
Bending pliers
for wires up to
1.8 mm diam.

Wire Cutters and wire Cutting Scissors DUROTIP with Carbide Cutting Edges



06-8639 **06-8640**
ANGLE
130 mm DUROTIP
ANGLE
130 mm

for soft wire
up to diam.
for hard wire
up to diam.

0,5 mm 0,6 mm
0,3 mm 0,4 mm

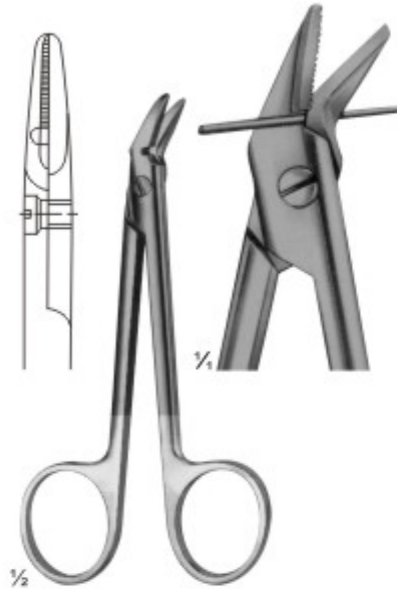

06-8641 **06-8642**
120 mm DUROTIP
120 mm

for soft wire
up to diam.
for hard wire
up to diam.

1,2 mm 1,2 mm
0,8 mm 0,8 mm

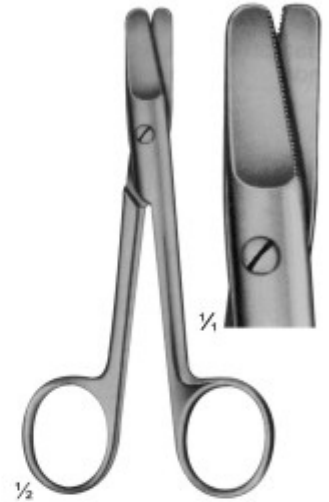

06-8643
HARVEY
125 mm

0,4 mm
0,3 mm



06-8644
150 mm

for soft wire
up to diam
for hard wire
up to diam

1,5 mm
1,0 mm



06-8645
160 mm

1,5 mm
1,2 mm



06-8646
140 mm
DUROTIP
1,5 mm

1,0 mm

Wire Cutting Pliers, Lateral Cutting Action



06-8647
180 mm

for soft wire
up to diam. 2,0 mm
For hard wire 1,5 mm
up to diam
specially hardened
cutting edges, front
and lateral cutting
action



06-8648
REILL
175 mm

for soft wire
up to diam. 2,0 mm
For hard wire 1,6 mm
up to diam
specially hardened
cutting edges, for
cutting off wires close
to the bone



DUROTIP

06-8649
235 mm

for soft wire
up to diam. 3,0 mm
For hard wire 2,2 mm
up to diam

Wire Cutting Pliers, Lateral and Front Cutting Action



06-8650
240 mm

for soft wire
up to diam. 2,0 mm
For hard wire
up to diam 1,6 mm



06-8651
145 mm

for soft wire
up to diam. 1,5 mm
For hard wire
up to diam 1,0 mm



06-8652
145 mm

for soft wire
up to diam. 2,0 mm
For hard wire
up to diam 1,5 mm



06-8653
220 mm

for soft wire
up to diam. 3,5 mm
For hard wire
up to diam 2,5 mm

Wire Cutting Pliers



06-8654
320 mm

for soft wire up to diam. 3,0 mm
For hard wire up to diam. 3,0 mm



Cutter for cutting off KIRSCHNER wires, Tibia head screws, bolts, pins, up to 3 mm diam.



DUROTIP

06-8655
Cutter for cutting off KIRSCHNER wires, Tibia head screws, bolts, pins, up to 6 mm diam. 470 mm

Finger Nail Instruments

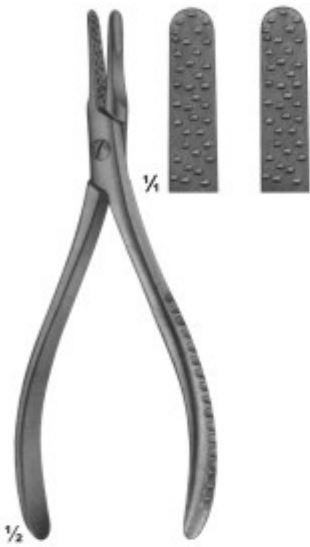

06-8656
Nail extracting
forceps
135 mm



06-8657
Nail extracting
forceps
145 mm



06-8658
Finger nail drill
with 3 drill points

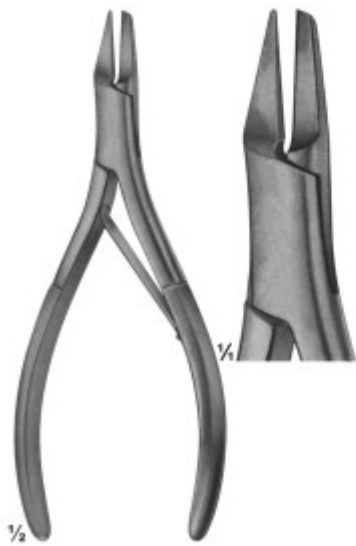

06-8662
Nail splitting
forceps
135 mm



06-8663
SYSTRUNK
Scissors, for splitting
finger nails
130 mm



06-8664
Finger ring saw
150 mm

Spare blade
06-8665

Plaster Instruments

Plaster Knives



with ebony handle

07-9001
HOPKINS
200 mm



07-9002
ESMARCH
180 mm

Plaster Saw



07-9003
ENGEL
160 mm

Bandage and First-Aid scissors



$\frac{1}{2}$
07-9004 - 07-9012 145mm

07-9004 black	07-9008 yellow
07-9005 red	07-9009 white
07-9006 blue	07-9010 orange
07-9007 light green	07-9011 violet
	07-9012 bright pink



$\frac{1}{2}$
07-9013 - 07-9021 180mm

07-9013 black	07-9017 yellow
07-9014 red	07-9018 white
07-9015 blue	07-9019 orange
07-9016 light green	07-9020 violet
	07-9021 bright pink

Plaster Scissors

For small plaster dressings



07-9022
160 mm

1/2



07-9023 - 07-9024
ESMARCH
07-9023 200mm
07-9024 230mm

1/2



07-9025
BERGMANN
230 mm

1/2



07-9026
BRUNS
235 mm

1/2



07-9027
235 mm

1/2

also to be used as
bandage scissors



07-9028
SEUTIN
230 mm

1/2

also to be used as
bandage scissors

Plaster Shears

Special features:

The construction of the open jaws avoids tiresome clogging by plaster remnants and allows furthermore an easy cleaning. The shears do not glide off the plaster owing to the deep teething on the jaws. The knives with hollow grinding have a better cutting ability and therefore less force is required. The knives are guided by ball bearings.

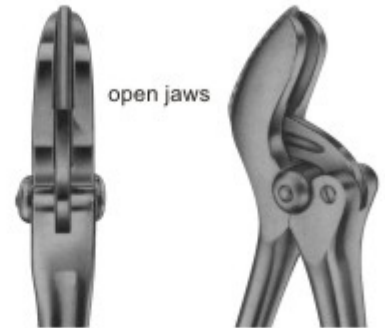

07-9029
STILLE
260 mm



07-9030
STILLE
360 mm

STILLE Plaster Shears

Blade with reinforced back



07-9032
STILLE
230 mm

07-9033
Spare blade



07-9034
STILLE
370 mm

07-9035
Spare blade



07-9036
STILLE
240 mm

07-9037
Spare blade

Plaster Spreader, Plaster Breakers



07-9038
HENNIG
270 mm



07-9039
MOD.USA
230 mm



07-9040
290 mm



with removable jaws



07-9041 - 07-9042
WOLFF
07-9041 180 mm
07-9042 240 mm
plaster breakers

Vacuum Currettes for Aspiration Lipectomy, Suction Instruments

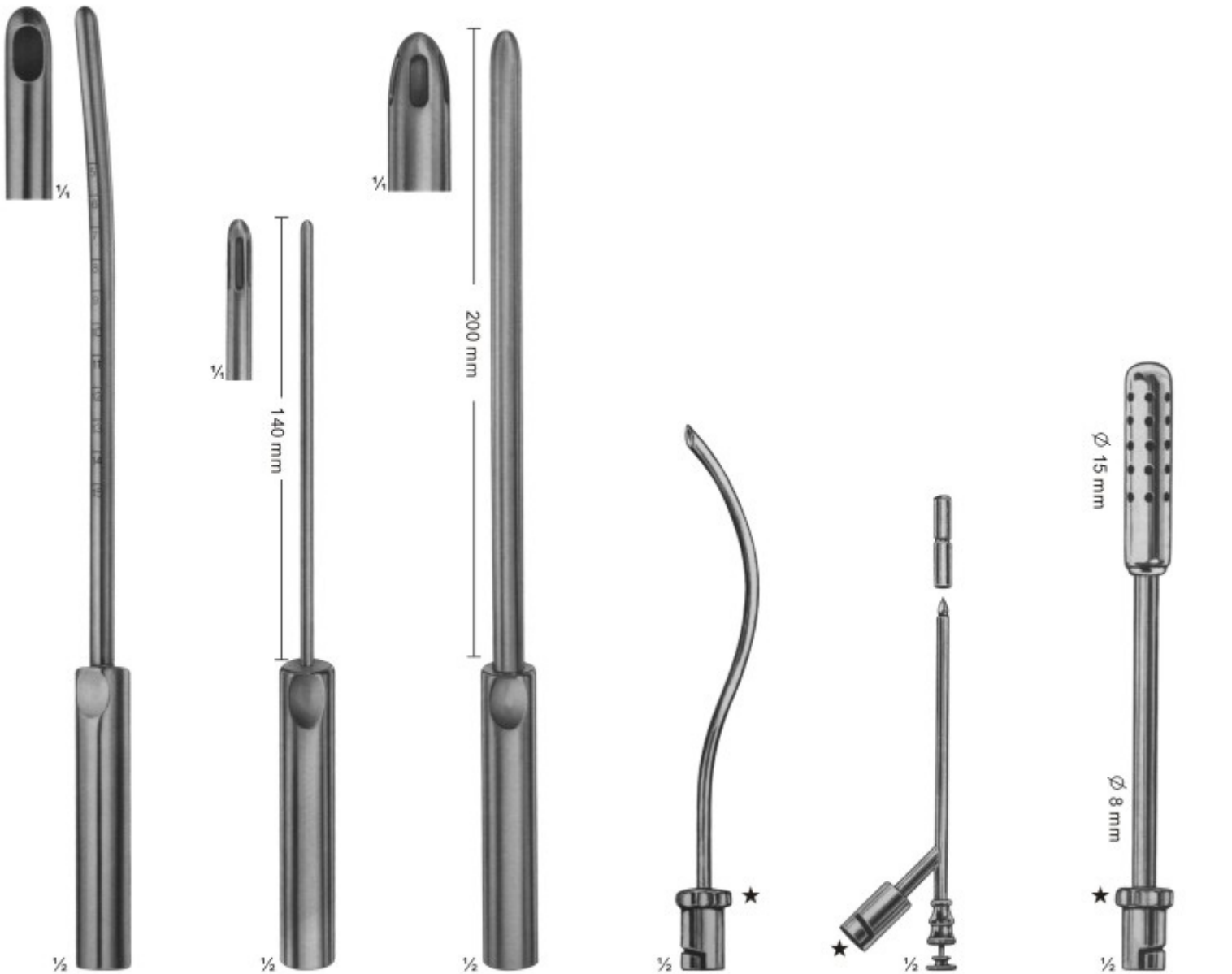

07-9043 - 07-9048

BIEMER

- 07-9043 ∅ 4 mm
- 07-9044 ∅ 6 mm
- 07-9045 ∅ 8 mm
- 07-9046 ∅ 10 mm
- 07-9047 ∅ 12 mm
- 07-9048 ∅ 14 mm

Currettes for aspiration lipectomy, graduated, slightly curved

07-9049 - 07-9050

BIEMER

- 07-9049 ∅ 4 mm
- 07-9050 ∅ 6 mm

Currettes for aspiration lipectomy, with three apertures, slightly curved malleable

07-9051 - 07-9053

BIEMER

- 07-9051 ∅ 8 mm
- 07-9052 ∅ 10 mm
- 07-9053 ∅ 12 mm

Currettes for aspiration lipectomy, with three apertures, slightly curved malleable

07-9054

For aspirating fluid from the excretory ducts of large glands and for keeping the operating area clear 170 mm

07-9055

Trocar

For puncturing 150 mm

07-9056

For clearing large quantities of fluid 190 mm

Suction Instruments

07-9057 150mm
Suction handle, with vacuum regulator and finger cut-off, brass, mirror-finish chromium-plated



olive
Ø 9 mm

07-9058 170mm
Suction handle, with hand regulation valve and quick-shutter, brass, mirror-finish chromium-plated



Both suction handles have bayonet fitting olive and can be used for the suction cannulae. Ø 9 mm



07-9059
Trocar
For puncturing
170 mm



07-9060
Hollow needle,
sharp
150 mm



07-9061
double curved
For general
surgery
230 mm



07-9062
For tonsillectomy,
oral and laryngeal
operations
190 mm



07-9063
For tonsillectomy,
oral and laryngeal
operations
220 mm

★ With bayonet fitting to be used with suction handles (07-9057 - 07-9058)

Suction Instruments

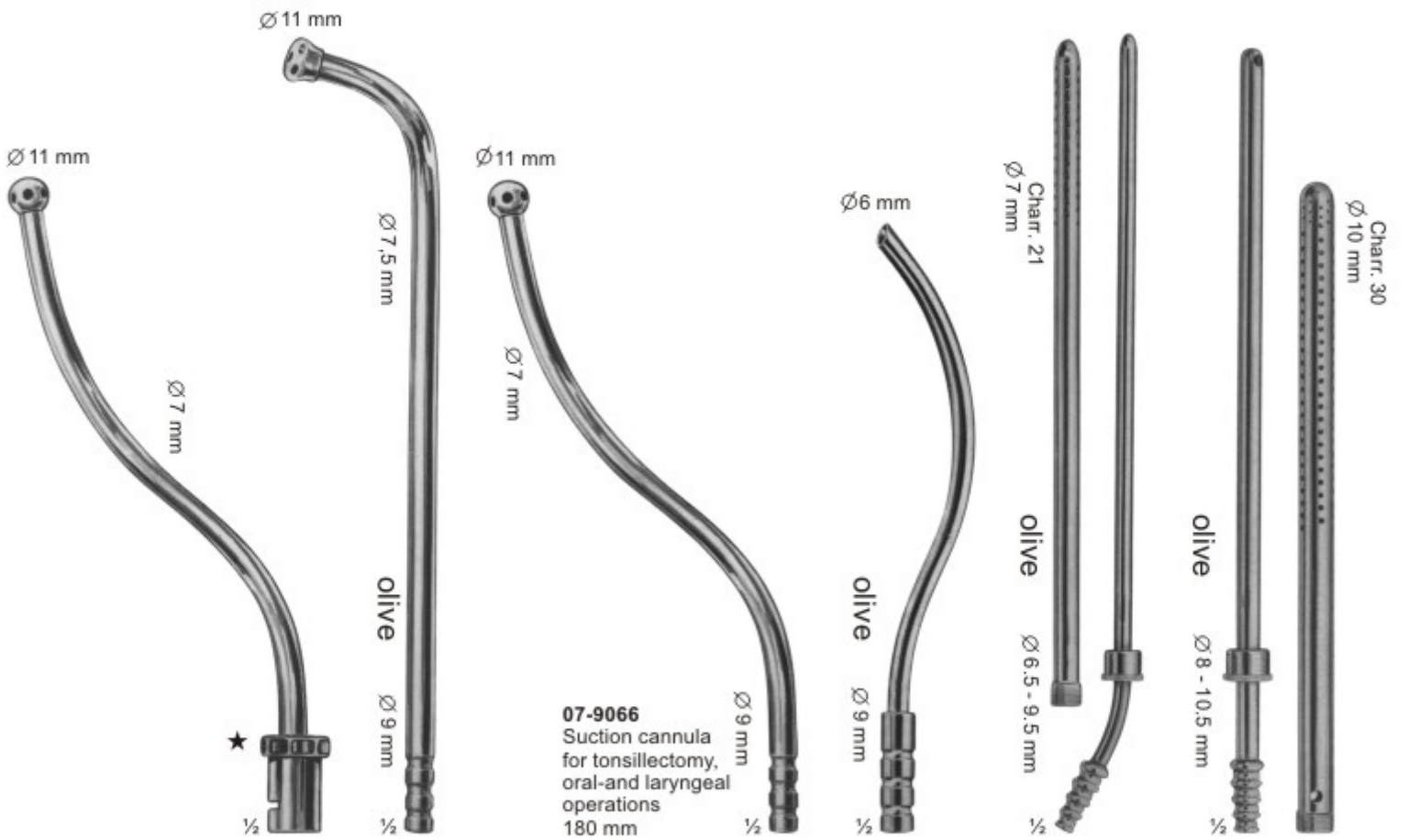

07-9064
For tonsillectomy,
oral-and laryngeal
operations
180 mm

07-9065
Suction cannula
for tonsillectomy,
oral-and laryngeal
operations
220 mm

07-9066
Suction cannula
for tonsillectomy,
oral-and laryngeal
operations
180 mm

07-9067
S-shaped blunt cannula
for aspirating fluid from
the excretory ducts of
large glands and for
keeping the operating
area clear
170 mm

07-9068
POOL
Suction cannula,
with outer tube
to be screwed of
225 mm

07-9069
POOL
Suction cannula,
with outer tube
to be screwed off
225 mm

Suction Instruments

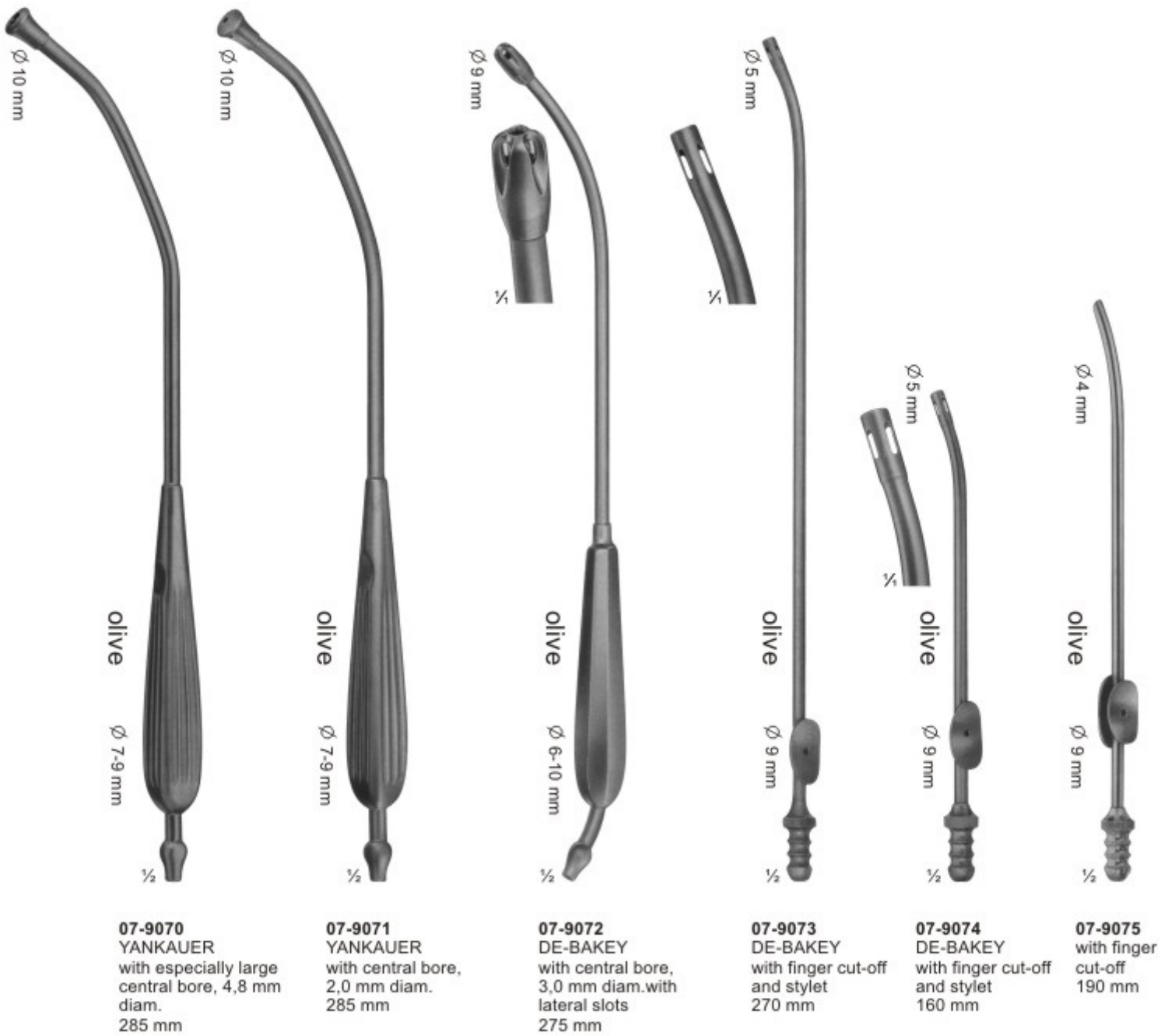

Suction Instruments



07-9076 Ø 1,5 mm
07-9077 Ø 2,0 mm
07-9078 Ø 2,5 mm
07-9079 Ø 3,0 mm

07-9076 - 07-9079
PLESTER
with finger cut-off and
stylet, thumb piece
parallel to curve, with
LUER hub
195 mm

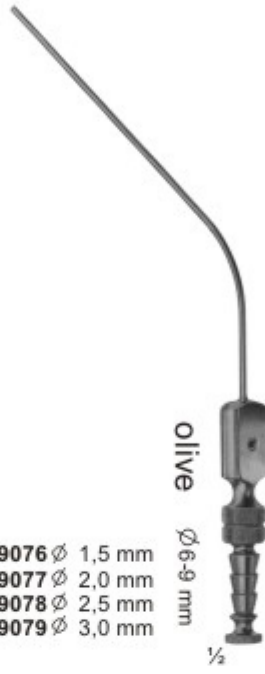

07-9080 Ø 2,0 mm
07-9081 Ø 2,5 mm
07-9082 Ø 3,0 mm
07-9083 Ø 4,0 mm
07-9084 Ø 5,0 mm

07-9080 - 07-9084
FERGUSSON
with finger cut-off and
stylet, thumb piece
90° to curve, with
LUER hub
180 mm



07-9085 4, Ømm
FERGUSSON
insulated, with finger cut-off
and stylet, thumb piece 90°
to curve, with LUER hub
180 mm



07-9086 3, Ømm
07-9087 5, Ømm
FRAZIER
with finger
cut-off and stylet, thumb
piece 90° to curve,
with LUER hub
180 mm

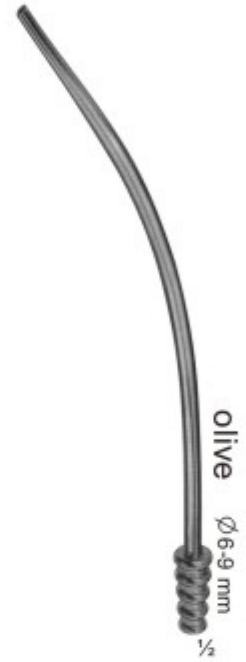

07-9088
5,0 mm diam., Tip
6,5 mm wide, Nasal
suction tube, with
LUER hub
180 mm



07-9089 4, Ømm
07-9090 5, Ømm
Nasal suction
tubes
175 mm



07-9091
GORNEY
Suction dissector
180 mm



07-9092 4 mm wide
07-9093 5 mm wide
Suction raspatories,
sharp, bayonet-shaped,
with stylet
200 mm



07-9094
LOPEZ-REINKE
Tonsil dissector with
suction device
235 mm

Suction Instruments

07-9095
WULLSTEIN
Suction tube, conical, silver, olive
with LUER hub
160 mm



07-9096 1,5 mm
07-9097 2,0 mm
WULLSTEIN
Suction tube, cylindrical, silver, with
stylet olive with LUER hub
160 mm



Usable length

YASARGIL usable length diam.		YASARGIL usable length diam.	
07-9098	130 mm 1,5 mm	07-9106	130 mm 2,5 mm
07-9099	150 mm 1,5 mm	07-9107	150 mm 2,5 mm
07-9100	180 mm 1,5 mm	07-9108	180 mm 2,5 mm
07-9101	220 mm 1,5 mm	07-9109	220 mm 2,5 mm
07-9102	130 mm 2,0 mm	07-9110	130 mm 3,5 mm
07-9103	150 mm 2,0 mm	07-9111	150 mm 3,5 mm
07-9104	180 mm 2,0 mm	07-9112	180 mm 3,5 mm
07-9105	220 mm 2,0 mm	07-9113	220 mm 3,5 mm
		07-9114	180 mm 4,5 mm

olive
Ø6,5-9 mm
with LUER hub

07-9115 - 07-9117
LANDOLT
150 MM
diam Ø 3 mm

07-9115 8 mm / curved
07-9116 11mm / curved
07-9117 15mm / curved

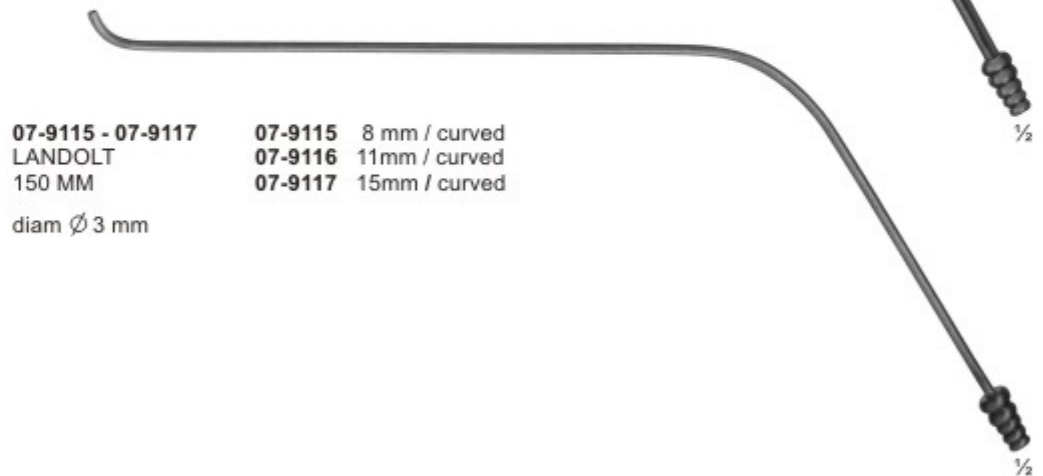

07-9118 500 mm
07-9119 350 mm
with rubber tip,
with LUER hub

07-9120 2,0 mm diam
07-9121 2,5 mm diam
07-9122 3,0 mm diam
with finger cut-off,
thumb piece 90° to
curve, with LUER hub
250 mm



Combined Suction and Irrigation Cannulae, Coagulation Suction Cannulae



07-9124
YASARGIL
LUER-LOCK cone
200 mm

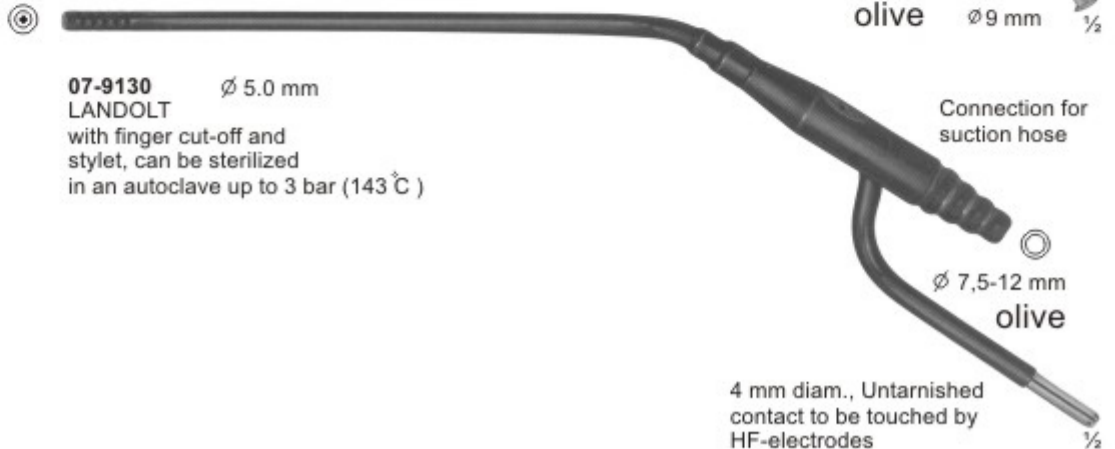
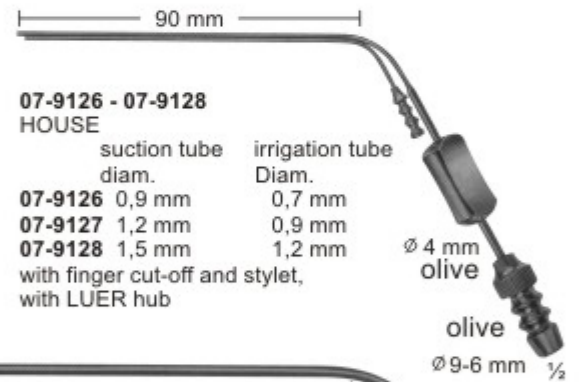
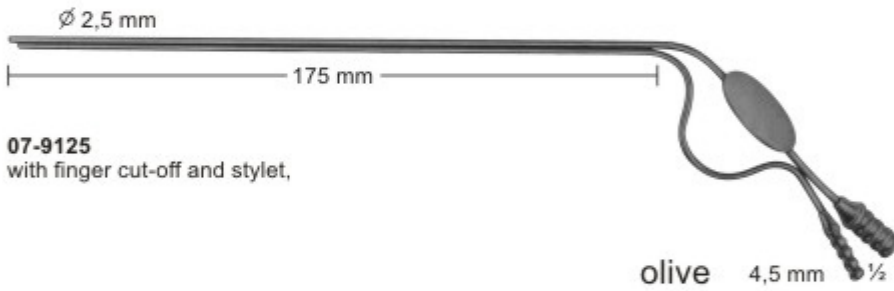

Scissors with Tungsten Carbide Inserts



07-9131 - 07-9133
STANDARD

07-9131 14,5cm
07-9132 16,5cm
07-9133 18,5cm



07-9134 - 07-9136
STANDARD

07-9134 14,5cm
07-9135 16,5cm
07-9136 18,5cm



07-9137 - 07-9139
STANDARD

07-9137 14,5cm
07-9138 16,5cm
07-9139 18,5cm



07-9140 - 07-9142
STANDARD

07-9140 14,5cm
07-9141 16,5cm
07-9142 18,5cm



07-9143 - 07-9145
STANDARD

07-9143 14,5cm
07-9144 16,5cm
07-9145 18,5cm



07-9146 - 07-9148
STANDARD

07-9146 14,5cm
07-9147 16,5cm
07-9148 18,5cm

Scissors with Tungsten Carbide Inserts



07-9149
MAYO-LEXER
16cm

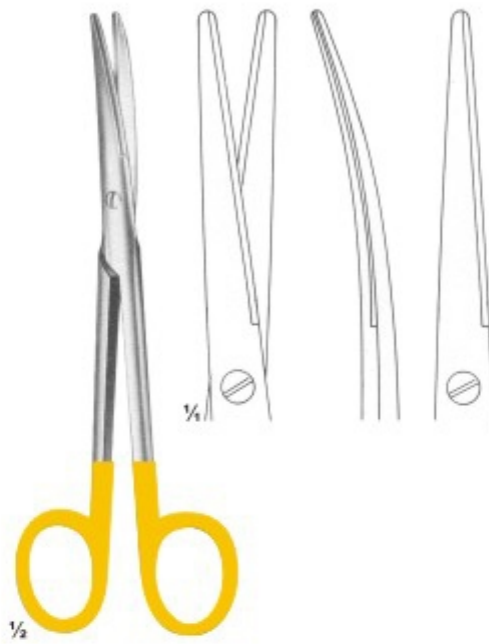

07-9150
MAYO-LEXER
16cm



07-9151 - 07-9152
LEXER

07-9151 16cm
07-9152 21cm

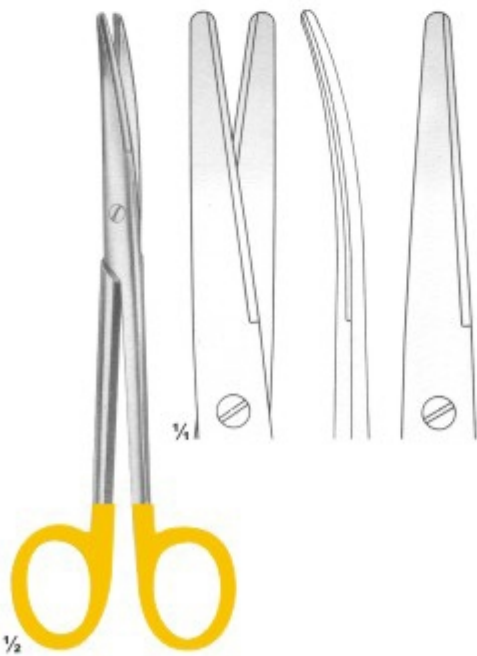

07-9153 - 07-9154
LEXER

07-9153 16cm
07-9154 21cm



07-9155 - 07-9156
MAYO-STILLE

07-9155 15cm
07-9156 17cm

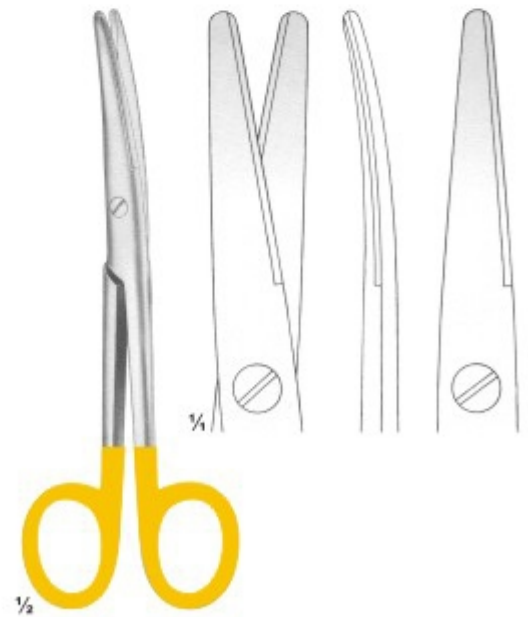

07-9157 - 07-9158
MAYO-STILLE

07-9157 15cm
07-9158 17cm

Scissors with Tungsten Carbide Inserts



07-9159 - 07-9160
METZENBAUM

07-9159 11.5cm
07-9160 14.5cm



07-9161 - 07-9164
METZENBAUM

07-9161 11.5cm
07-9162 14.5cm
07-9163 23cm
07-9164 25cm



07-9165 - 07-9170
METZENBAUM

07-9165 18cm
07-9166 20cm
07-9167 23.5cm
07-9168 25.5cm
07-9169 28cm
07-9170 30cm



07-9171 - 07-9176
METZENBAUM-FINO

07-9171 14cm
07-9172 18cm
07-9173 20cm
07-9174 23cm
07-9175 25cm
07-9176 28cm



07-9177 - 07-9182
METZENBAUM-FINO

07-9177 14cm
07-9178 18cm
07-9179 20cm
07-9180 23cm
07-9181 25cm
07-9182 28cm

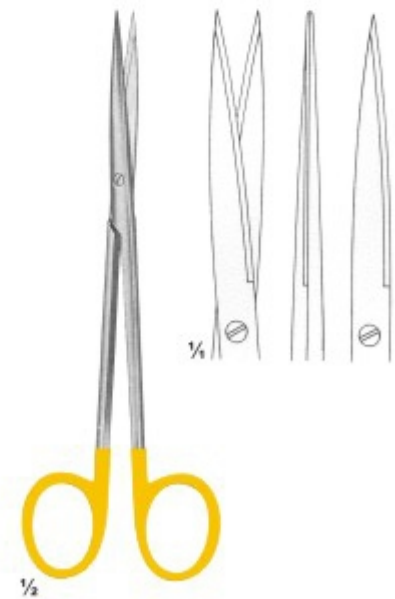

07-9183 - 07-9186
METZENBAUM-FINO

07-9183 14cm
07-9184 18cm
07-9185 20cm
07-9186 23cm

Scissors with Tungsten Carbide Inserts

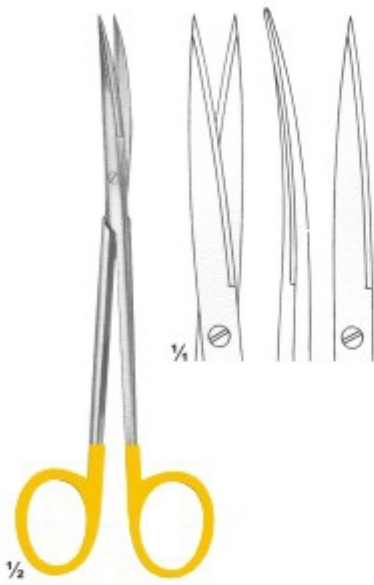

07-9187 - 07-9190
METZENBAUM-FINO

- 07-9187** 14cm
- 07-9188** 18cm
- 07-9189** 20cm
- 07-9190** 23cm

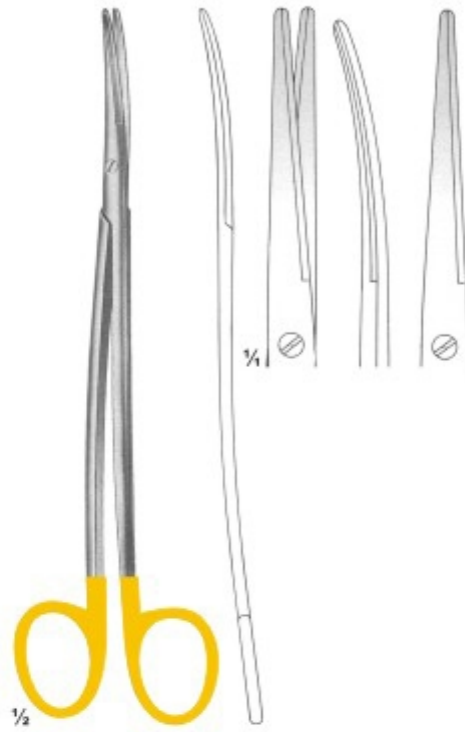

07-9191 - 07-9193
METZENBAUM-FINO

- 07-9191** 18cm
- 07-9192** 20cm
- 07-9193** 23cm

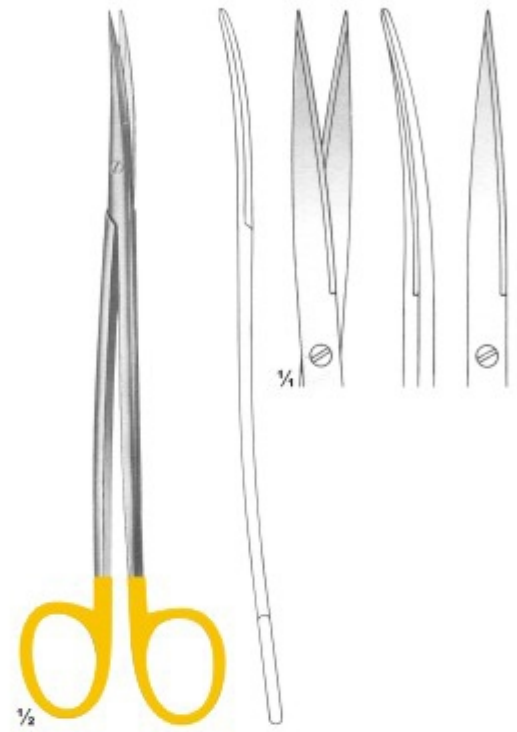

07-9194 - 07-9196
METZENBAUM-FINO

- 07-9194** 18cm
- 07-9195** 20cm
- 07-9196** 23cm

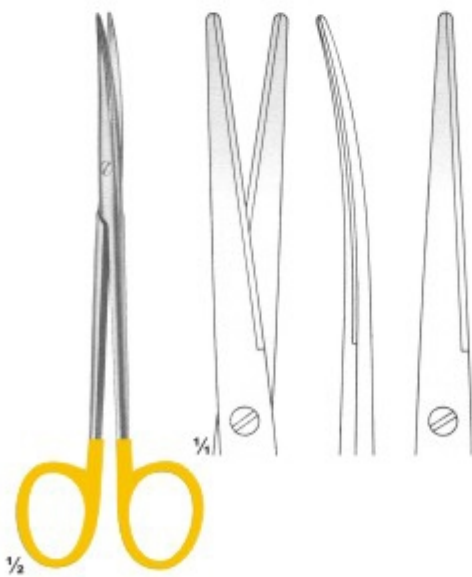

07-9197 - 07-9198
METZENBAUM

- 07-9197** 20cm
- 07-9198** 23cm



07-9199 - 07-9201
MAYO

- 07-9199** 14.5cm
- 07-9200** 17cm
- 07-9201** 23cm

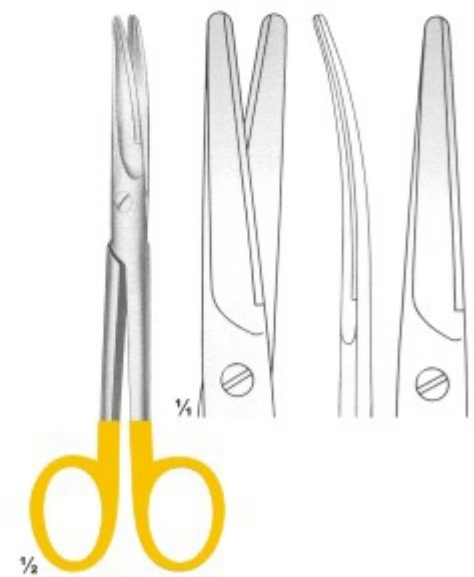

07-9202 - 07-9204
MAYO

- 07-9202** 14.5cm
- 07-9203** 17cm
- 07-9204** 23cm

Scissors with Tungsten Carbide Inserts

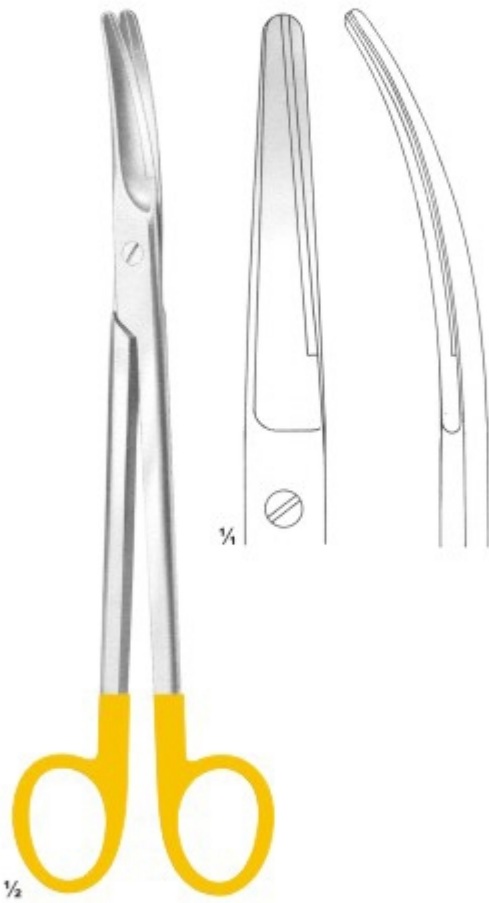

07-9205
WERTHEIM
Dissecting Scissors
23cm

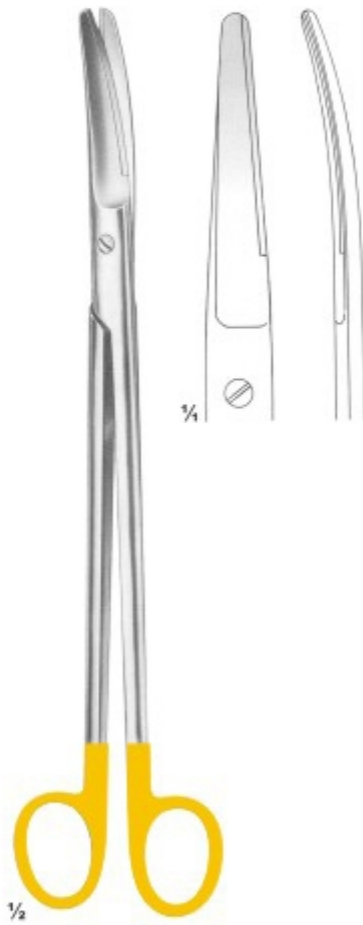

07-9206
SIMS
20cm
07-9207
23cm

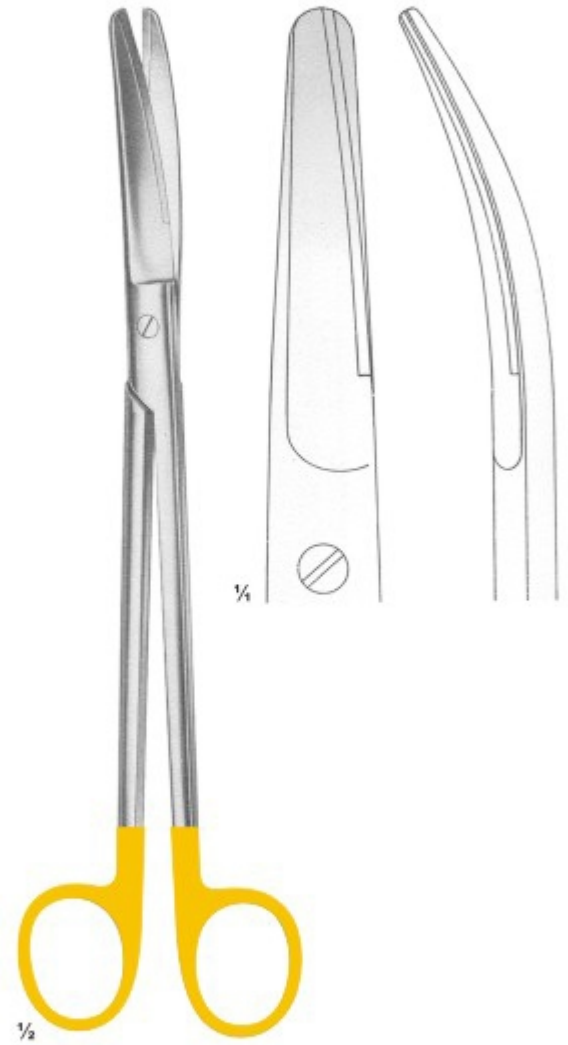

07-9208
MAYO-HARRINGTON
28cm

Scissors with Tungsten Carbide Inserts

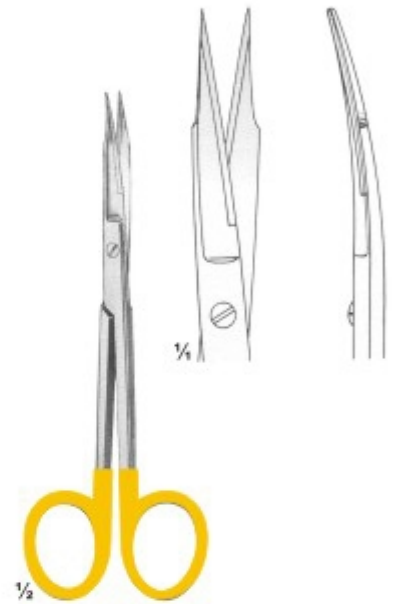
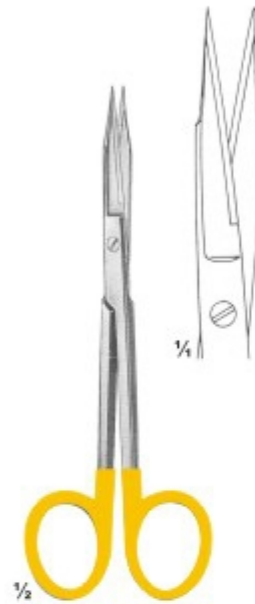

07-9212 - 07-9214 DE-BAKEY (Potts-Smith)	07-9212 19cm 25° 07-9213 19cm 45° 07-9214 19cm 60°	07-9215 GOLDMANN FOX 13cm
---	---	--

07-9209 - 07-9211 DE-BAKEY (Potts-Smith)	07-9209 23cm 25° 07-9210 23cm 45° 07-9211 23cm 60°
---	---

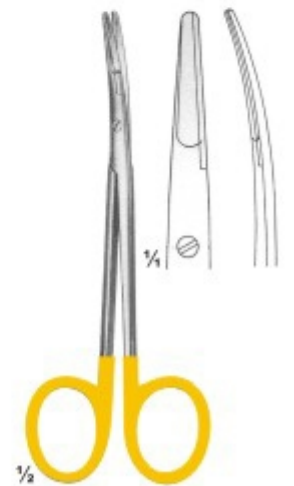
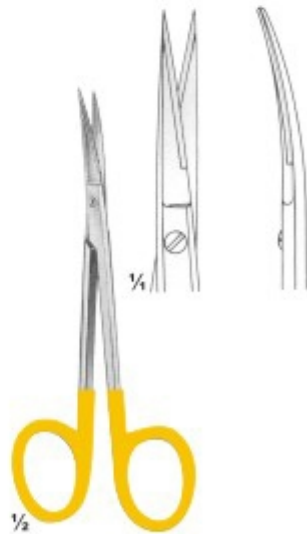
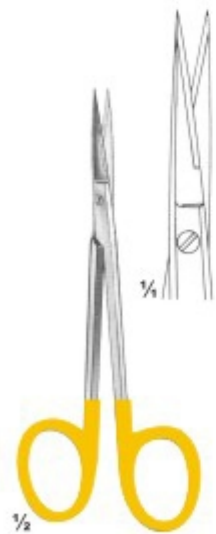

07-9217
Fine Scissor
11,5cm

07-9218
Fine Scissor
11,5cm

07-9219
11,5cm

07-9220
RAGNELL (Kilner)
12cm

Scissors & Dissecting Forceps with Tungsten Carbide Inserts



07-9221
UNIVERSAL
12cm



07-9222 - 07-9224
SUTURE SCISSORS
1 Black & 1 Gold Plated ring

07-9222 14cm
07-9223 17cm
07-9224 23cm

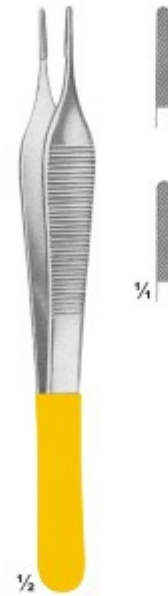

07-9225 - 07-9226
ADSON
07-9225 12cm
07-9226 15cm



07-9227
CUSHING
With dissector end
17,5cm



07-9228
CUSHING
With dissector end
18cm



07-9229
CUSHING-TAYLOR
18cm



07-9230
DISSECTING FORCEPS
15cm



07-9231
SEMKEN
15cm

Dissecting Forceps and Needle holders with Tungsten Carbide Inserts

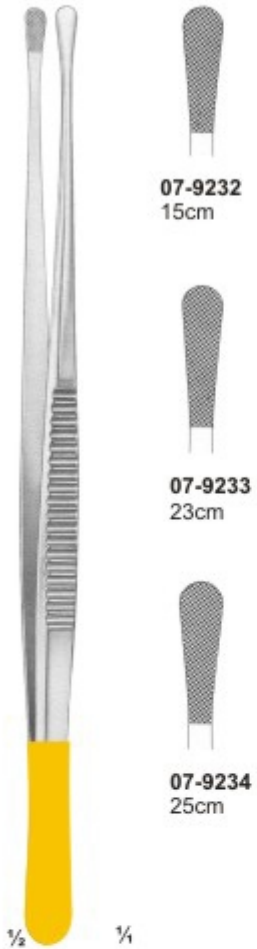

07-9232
15cm

07-9233
23cm

07-9234
25cm

07-9232 - 07-9234
WANGENSTEEN

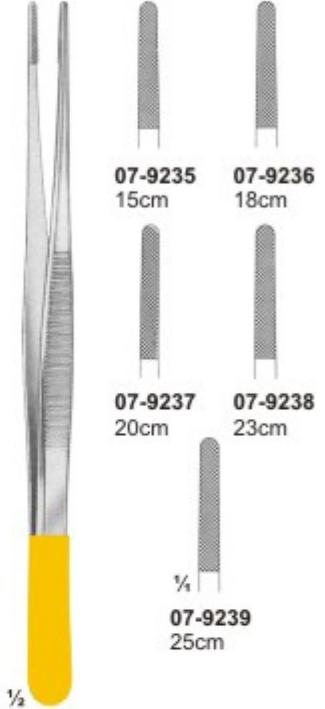

07-9235
15cm

07-9236
18cm

07-9237
20cm

07-9238
23cm

1/4
07-9239
25cm

07-9235 - 07-9239
POTTS-SMITH

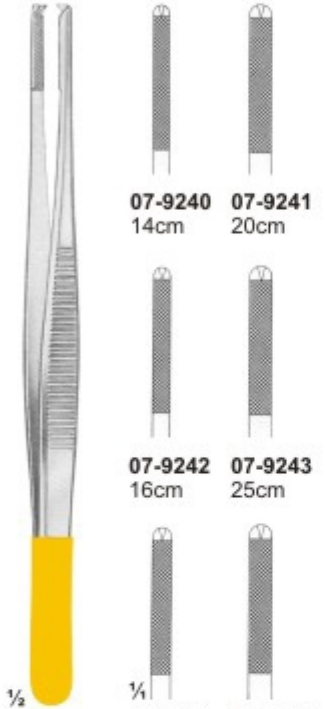

07-9240
14cm

07-9241
20cm

07-9242
16cm

07-9243
25cm

07-9244
18cm

07-9245
30cm

07-9240 - 07-9245
OEHLER



07-9246
POTTS-SMITH
22cm



Smooth Jaw

07-9247
HEPP-SCHEIDEL
18cm



07-9248
CASTROVIEJO
14cm



07-9249
CASTROVIEJO
14cm



07-9250
ARRUGA
16cm

Needle holders with Tungsten Carbide Inserts



07-9251
ARRUGA
16cm



07-9252
CASTROVIEJO
13cm

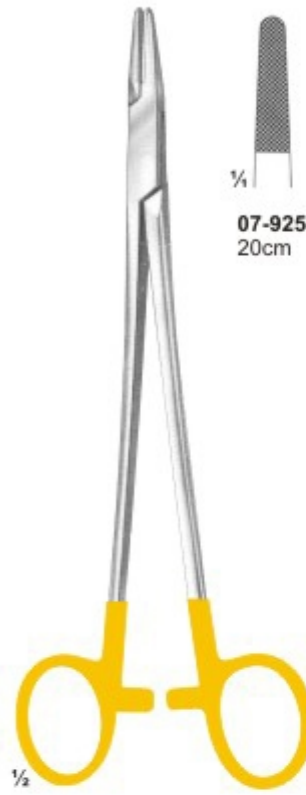

07-9253 - 07-9254
HEGAR

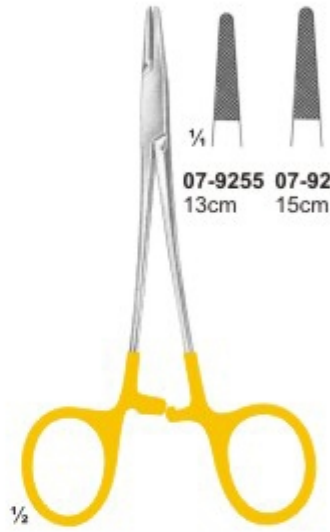

07-9255 - 07-9256
HALSEY



07-9257 - 07-9262
MAYO-HEGAR



07-9263 - 07-9268
DE-BAKEY



07-9269 - 07-9272
HEGAR-VASCULAR

Needle holders with Tungsten Carbide Inserts



07-9273 - 07-9275
BOZEMANN

07-9273 20cm
07-9274 24cm
07-9275 26cm

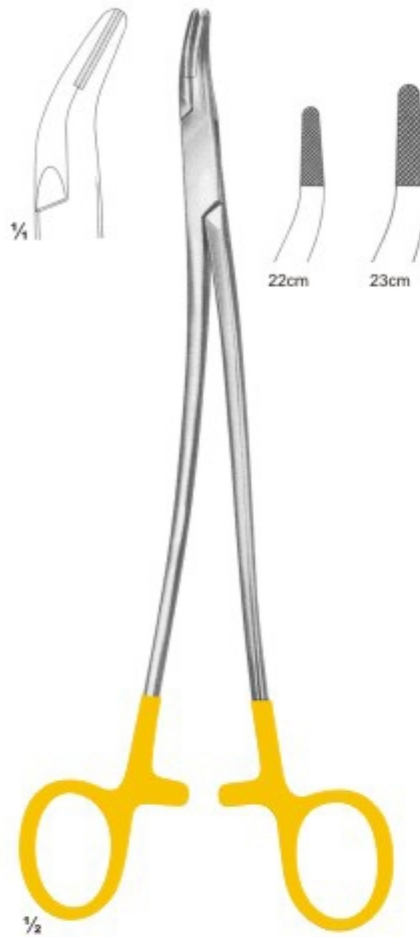

07-9276 - 07-9277
STRATTE

07-9276 22cm
07-9277 23cm

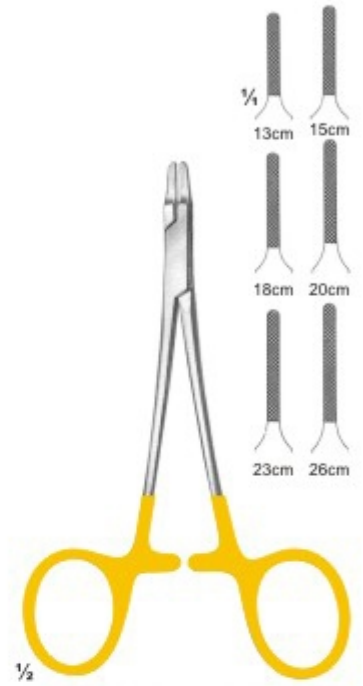

07-9278 - 07-9283
RYDER

07-9278 13cm
07-9279 15cm
07-9280 18cm
07-9281 20cm
07-9282 23cm
07-9283 26cm



07-9284 - 07-9288
RYDER-VASCULAR

07-9284 13cm
07-9285 15cm
07-9286 20cm
07-9287 23cm
07-9288 26cm



07-9289 - 07-9291
MARTIN

07-9289 15cm
07-9290 17cm
07-9291 20cm



07-9292 - 07-9294
SAROT

07-9292 18cm
07-9293 20cm
07-9294 26cm

Needle holders with Tungsten Carbide Inserts

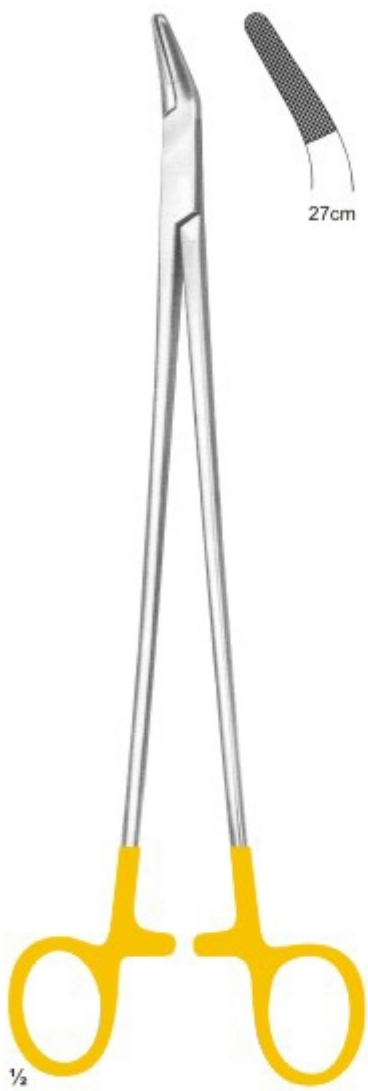

07-9295
FINOCHIETTO
27cm



07-9296 - 07-9297A
HEANEY
07-9296 20cm
07-9297 24cm
07-9297A 26cm

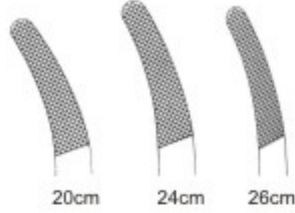

07-9298 - 07-9300
MATHIEU
07-9298 14cm
07-9299 17cm
07-9300 20cm

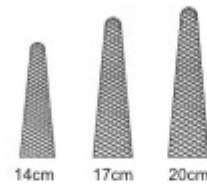

07-9301 - 07-9303
MATHIEU
07-9301 17cm
07-9302 20cm
07-9303 23cm



07-9304 - 07-9307
MATHIEU-KOCHER
07-9304 14cm
07-9305 17cm
07-9306 20cm
07-9307 24cm

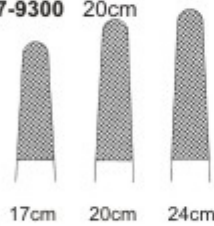

07-9308 - 07-9310
MATHIEU
07-9308 17cm
07-9309 20cm
07-9310 24cm



07-9311 - 07-9313
MATHIEU-VASCULAR
07-9311 17cm
07-9312 20cm
07-9313 24cm

Needle holders with Tungsten Carbide Inserts

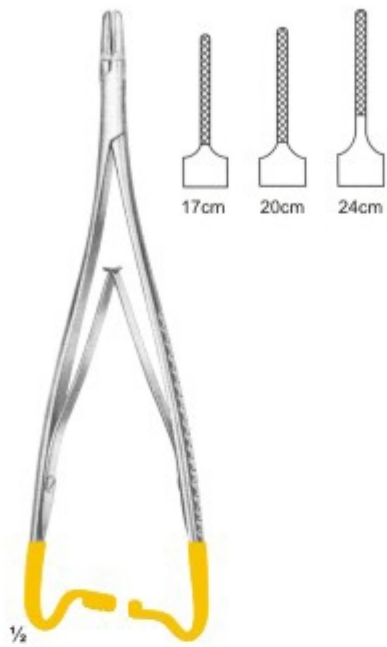

07-9314 - 07-9316
MATHIEU-RYDER
07-9314 17cm
07-9315 20cm
07-9316 24cm



07-9317
LICHTENBERG
20cm



07-9318 - 07-9319
LANGHALS
07-9318 20cm
07-9319 25cm



07-9320 - 07-9321
LICHTENBERG
07-9320 20cm
07-9321 25cm



07-9322 - 07-9323
LUETHY-BECK
07-9322 20cm
07-9323 25cm



07-9324 - 07-9325
LUETHY-BECK
07-9324 20cm
07-9325 25cm



07-9326 - 07-9328
LANGENBECK
07-9326 18cm
07-9327 20cm
07-9328 23cm



07-9329 - 07-9331
LANGENBECK
07-9329 18cm
07-9330 20cm
07-9331 23cm

Needle holders with Tungsten Carbide Inserts and Without TC



07-9332
STEVENS
15 cm



07-9333
KALT
14 cm



07-9334
KALT "HM"
14 cm



07-9335 - 07-9338
CASTROVIEJO
07-9335 14 cm STR
07-9336 17 cm STR
07-9337 14 cm CVD
07-9338 17 cm CVD



07-9339 - 07-9340
CASTROVIEJO
07-9339 14 cm
07-9340 17 cm



07-9341
CASTROVIEJO "HM"
13 cm

Needle holders with Tungsten Carbide Inserts and Without TC



07-9342- 07-9345
CASTROVIEJO "HM"
07-9342 14 cm smooth
07-9343 17 cm smooth
07-9344 14 cm serrated
07-9345 17 cm serrated



07-9346 - 07-9347
CASTROVIEJO-MICRO
 14, 5 cm
07-9346 14.5 cm STR
07-9347 14.5 cm CVD



07-9348 - 07-9349
CASTROVIEJO-MICRO
 14, 5 cm
07-9348 14.5 cm STR
07-9349 14.5 cm CVD

Ultra Fine



07-9350 - 07-9351
CASTROVIEJO
(KOSHIMA)
 14, 5 cm
07-9350 14.5 cm STR
07-9351 14.5 cm CVD



07-9352 - 07-9353
CASTROVIEJO
(KOSHIMA)
 14, 5 cm
07-9352 14.5 cm STR
07-9353 14.5 cm CVD

Needle holders with Tungsten Carbide Inserts and Without TC



07-9354 - 07-9355
BARRAQUER
07-9354 11,5 cm
07-9355 14 cm



07-9356 - 07-9357
BARRAQUER
07-9356 11,5 cm
07-9357 14 cm



07-9358 - 07-9359
JACOBSON "HM"
07-9358 18,5 cm
07-9359 21 cm



07-9360 - 07-9361
JACOBSON "HM"
07-9360 18,5 cm
07-9361 21 cm



07-9362 - 07-9363
JACOBSON
07-9362 18,5 cm
07-9363 21 cm



07-9364 - 07-9365
JACOBSON "HM"
18 cm
07-9364 18 cm STR
07-9365 18 cm CVD



07-9366 - 07-9367
JACOBSON "HM"
18 cm
07-9366 18 cm STR
07-9367 18 cm CVD

Micro Needle Holders



07-9368 - 07-9369
MICRO 2000
12 cm
07-9368 12 cm STR
07-9369 12 cm CVD



07-9370 - 07-9371
MICRO 2000
12 cm
07-9370 12 cm STR
07-9371 12 cm CVD



07-9372
MICRO 2000
15 cm



07-9373 - 07-9374
MICRO 2000
15 cm
07-9373 15 cm STR
07-9374 15 cm CVD



07-9375 - 07-9376
YASARGIL
16 cm
07-9375 16 cm STR
07-9376 16 cm CVD

Wire Cutting Plier With T.C. Inserts



07-9377
TOENNIS
Elastic pattern for
dura-or intestinal suture
180 mm



07-9378
Cutting Plier
12 cm

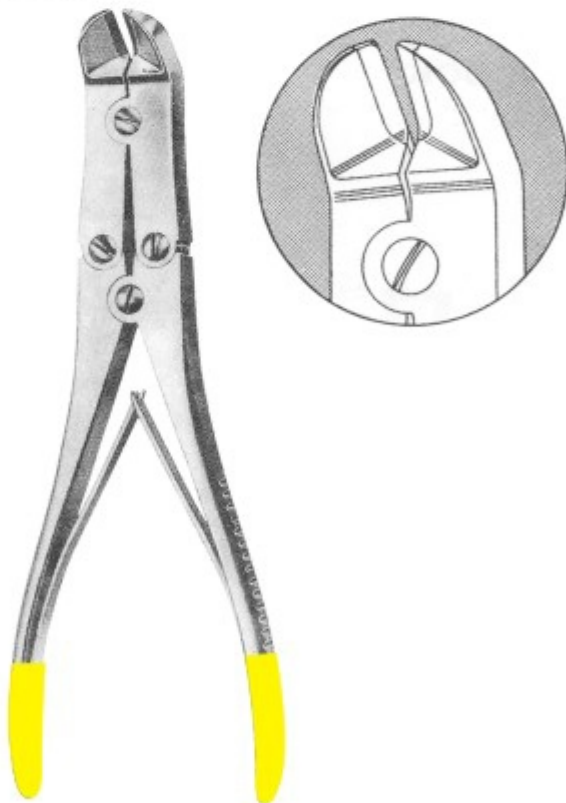

07-9379
MULLAR CLAUS
22 cm



07-9380
Plier
17.5 cm

Dressing Sterilizing Drums, Storing Cases and Needle Cases



07-9381 - 07-9395
SCHIMMELBUSCH
without filter laterally
perforated lockable
by sliding mechanism.

	Ø x H sizes in mm
07-9381	80 x 80
07-9382	105 x 120
07-9383	140 x 140
07-9384	160 x 120
07-9385	160 x 150
07-9386	190 x 150
07-9387	190 x 190
07-9388	240 x 160
07-9389	240 x 240
07-9390	290 x 160
07-9391	290 x 240
07-9392	340 x 160
07-9393	340 x 340
07-9394	390 x 190
07-9395	390 x 290



07-9396
BOX
120 x 65 x 13mm
(without Bulldog clamps,
without silicone tape)



07-9397 - 07-9409
KONRICH

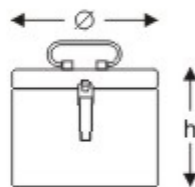

	Ø x H sizes in mm
07-9397	100 x 100
07-9398	150 x 150
07-9399	200 x 150
07-9400	200 x 190
07-9401	240 x 160
07-9402	240 x 230
07-9403	290 x 160
07-9404	290 x 240
07-9405	340 x 160
07-9406	340 x 240
07-9407	390 x 145
07-9408	390 x 240
07-9409	390 x 290



07-9410
Box with support for
needle electrodes,
without instruments

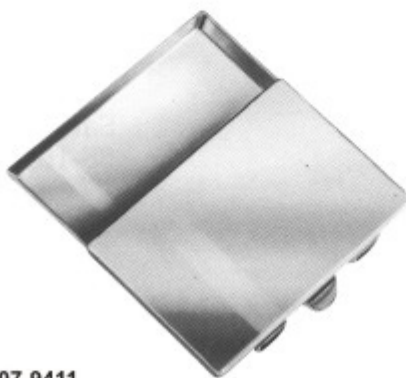

07-9411
50 x 25 x 4,5 mm
07-9412
65 x 42 x 8 mm
07-9413
75 x 25 x 4,5 mm



07-9414
Box with support
120 x 65 x 13 mm
(with bulldog clamps)

07-9415
Ø 62mmx13mm
Interior box
perforated lid
and bottom.



07-9416
complete with perforated
interior box.
Ø 65mm x 15mm

Jars and Instrument boxes



Ø x H	Jar without lid	lid only	lid only with triangle hole
30x90mm	07-9417	07-9426	07-9435
50x100mm	07-9418	07-9427	07-9436
50x130mm	07-9419	07-9428	07-9437
50x175mm	07-9420	07-9429	07-9438
75x100mm	07-9421	07-9430	07-9439
75x130mm	07-9422	07-9431	07-9440
75x175mm	07-9423	07-9432	07-9441
100x175mm	07-9424	07-9433	07-9442
100x200mm	07-9425	07-9434	07-9443

07-9417 - 07-9443



07-9468
205 x 105 x 35 mm

07-9444 - 07-9467

	L x B x H	Lid with knob	Lid without knob
07-9444	165 x 85 x 35 mm	07-9452	07-9460
07-9445	200 x 100 x 35 mm	07-9453	07-9461
07-9446	200 x 100 x 50 mm	07-9454	07-9462
07-9447	230 x 130 x 50 mm	07-9455	07-9463
07-9448	260 x 150 x 50 mm	07-9456	07-9464
07-9449	270 x 235 x 50 mm	07-9457	07-9465
07-9450	300 x 200 x 50 mm	07-9458	07-9466
07-9451	325 x 275 x 50 mm	07-9459	07-9467

Dressing Forceps in Jar with Cap



07-9469 - 07-9470

- 07-9469** Sterilizing Forceps
consisting of:
1 Sterilizing Forceps, curved, 25 cm,
without ratchet, with lid for jar
1 jar with wide bottom plate (anti-tilt)
- 07-9470** ditto, with 32 cm long Sterilizing Forceps

Round Metal Boxes, Medicine Cups and Kidney Dishes



Lid with knob

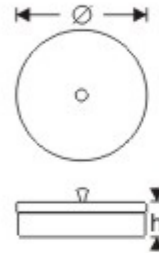

07-9471 - 07-9477

	Ø x H
07-9471	75 x 60 mm
07-9472	75 x 75 mm
07-9473	100 x 60 mm
07-9474	100 x 100 mm
07-9475	125 x 80 mm
07-9476	125 x 125 mm
07-9477	150 x 150 mm



07-9478
25 cc
graduated
inside

07-9479
50 cc
graduated
inside



07-9480
20 cc
Medicine Spoon
graduated
inside



07-9481
Ø75 x 12 mm
Tablet Tray



07-9482
Ø90 x 90 mm
Metal Cup



07-9483
Ø75 x 80 mm
Sputum Cup



Kidney Dish



Lid for kidney dishes

07-9484 - 07-9486

	L x B x H
07-9484	170 x 100 x 35 mm
07-9485	250 x 140 x 40 mm
07-9486	275 x 150 x 45 mm

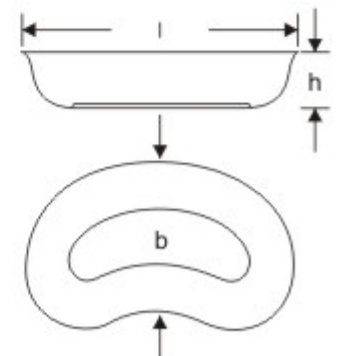

Round Bowls, Graduated Measures and Trays



07-9487 - 07-9494

	Ø x H		
07-9487	40 x 19 mm		0.05L
07-9488	61 x 30 mm		0.07L
07-9489	80 x 40 mm		0.14L
07-9490	116 x 50 mm		0.35L
07-9491	128 x 55 mm		0.45L
07-9492	147 x 65 mm		0.70L
07-9493	167 x 75 mm		1.10L
07-9494	187 x 85 mm		1.60L



07-9495 - 07-9499

	Ø x H		
07-9495	116 x 35 mm		0.30L
07-9496	128 x 38 mm		0.40L
07-9497	147 x 40 mm		0.50L
07-9498	157 x 45 mm		0.75L
07-9499	187 x 45 mm		1.00L



07-9500
 Ø 110 x 28 mm 0.15L



07-9501
 100 cc = 0.1L
 graduated
 inside



07-9502 - 07-9505
07-9502 0,25L
07-9503 0,50L
07-9504 1,00L
07-9505 2,00L
 graduated
 inside



07-9506
 235 x 190 x 40 mm



07-9507
 Ø 220 x 70 mm

Powder Strewer, Triangular Basins, Placenta and Bed Pans



07-9508
∅ 50 x 100 mm
Powder Pot



07-9509
∅ 50 x 75 mm
Methot With Lid



07-9510
∅ 50 x 75 mm
Methot Without Lid



graduated inside upto 600ml with handle

07-9511



graduated inside upto 600ml

07-9512



07-9513
PLACENTA PAN



07-9514 - 07-9515
BED PAN

07-9514 ∅ 235 mm
07-9515 ∅ 310 mm

Needle Sterilizing Cases



07-9516
Sauerbruch
210 x 125 x 17 mm
perforated lid and
bottom



07-9517
Sauerbruch
210 x 125 x 17 mm
perforated lid and
bottom



07-9518
150 x 95 x 13 mm



07-9519
150 x 95 x 13 mm
perforated lid and
bottom



07-9520
150 x 95 x 13 mm
perforated bottom



07-9521
150 x 95 x 13 mm
perforated lid and
bottom



07-9522
150 x 95 x 13 mm



07-9523
150 x 95 x 13 mm
perforated lid and
bottom



07-9524
150 x 95 x 11 mm
Needle tray perforated
bottom

Storing Cases Perforated Bottom with Textile Filter



07-9525
Deponette
245 x 135 x 35mm

Perforated bottom,
with textile filter ref.



07-9526
Deponette
245 x 135 x 50mm

Perforated bottom,
with textile filter ref.



07-9527
Deponette
245 x 135 x 60mm

Perforated bottom,
with textile filter ref.



All Bottoms with Filters

Universal Trays, Instruments Storing Trays and Sterilizing and Storing Cases



07-9528 - 07-9532

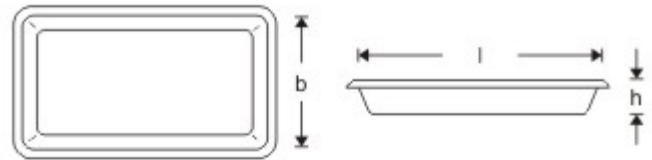

satin finish	size in mm l x b x h
07-9528	230 x 165 x 30
07-9529	300 x 155 x 30
07-9530	300 x 175 x 40
07-9531	350 x 240 x 36
07-9532	400 x 300 x 50

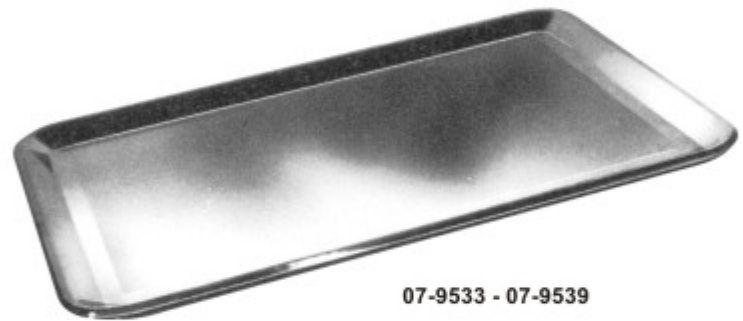

07-9533 - 07-9539

satin finish	size in mm Ø x H
07-9533	210 x 160 x 10
07-9534	240 x 180 x 10
07-9535	310 x 150 x 10
07-9536	310 x 210 x 10
07-9537	350 x 240 x 10
07-9538	400 x 270 x 20
07-9539	420 x 280 x 10



07-9540 - 07-9550

	L x H x B	
07-9540	230 x 130 x 50	mm
07-9541	260 x 150 x 50	mm
07-9542	275 x 235 x 50	mm
07-9543	300 x 200 x 50	mm
07-9544	325 x 275 x 50	mm
07-9545	420 x 175 x 50	mm
07-9546	230 x 130 x 75	mm
07-9547	260 x 150 x 75	mm
07-9548	300 x 200 x 75	mm
07-9549	325 x 275 x 75	mm
07-9550	420 x 175 x 75	mm

Sterilizing Baskets / Trays

Sterilizing tray of wire mesh
for container 30cm long

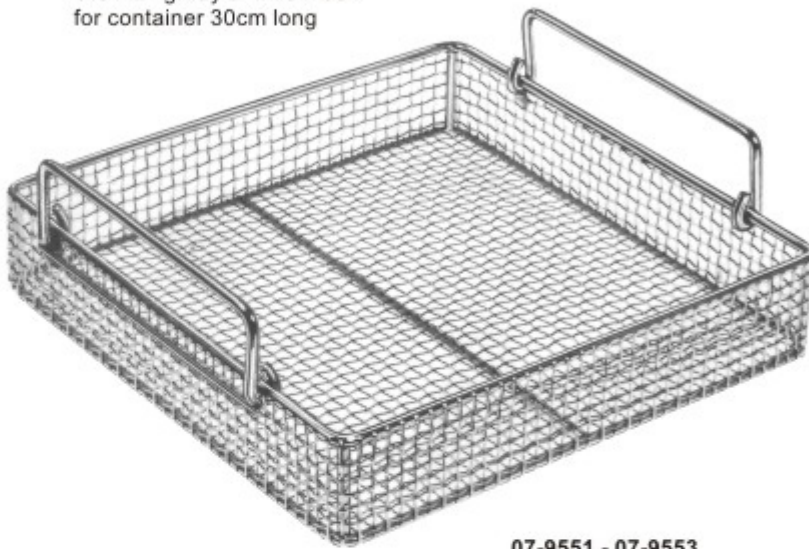

07-9553
250 x 250 x 50mm

07-9551 480 x 250 x 50 mm
07-9552 520 x 250 x 75 mm
07-9553 520 x 250 x 100 mm
 Sterilizing Trays of wire mesh
for container 60cm long.

07-9551 - 07-9553



Sterilizing tray of perforated steel sheet

07-9554 - 07-9559

07-9554 240 x 240 x 50 mm
07-9555 240 x 240 x 80 mm
07-9556 240 x 240 x 100 mm
07-9557 480 x 260 x 50 mm
07-9558 520 x 260 x 80 mm
07-9559 520 x 260 x 100 mm

Sterilizing Basket

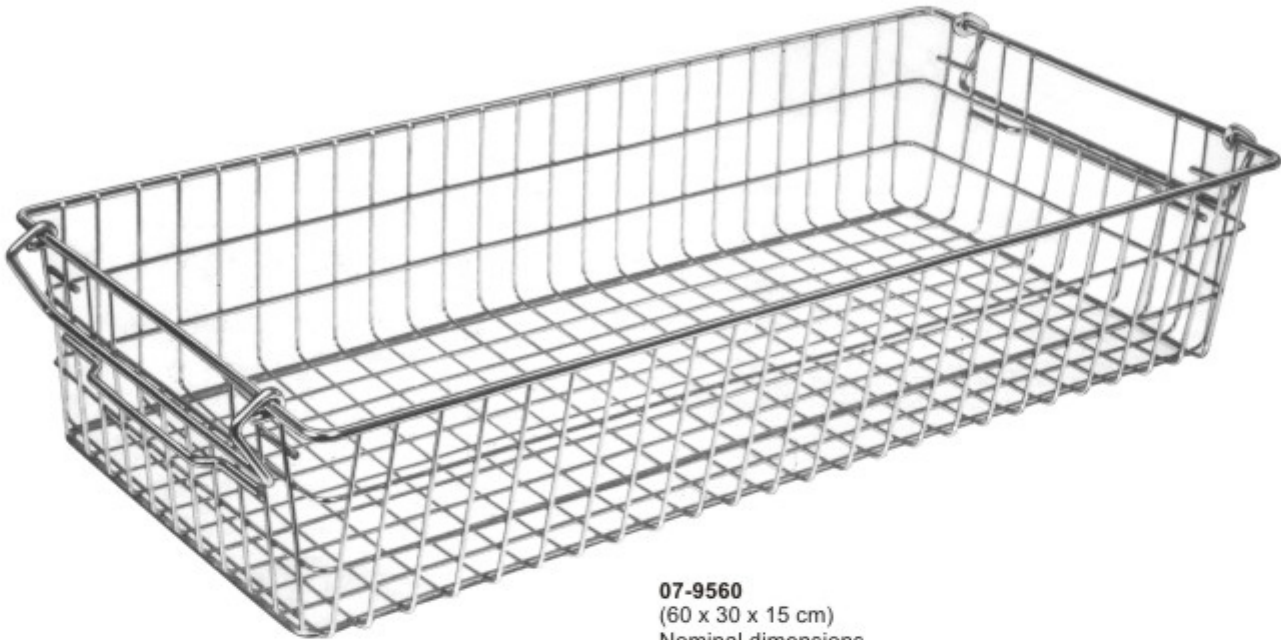

07-9560
(60 x 30 x 15 cm)
Nominal dimensions

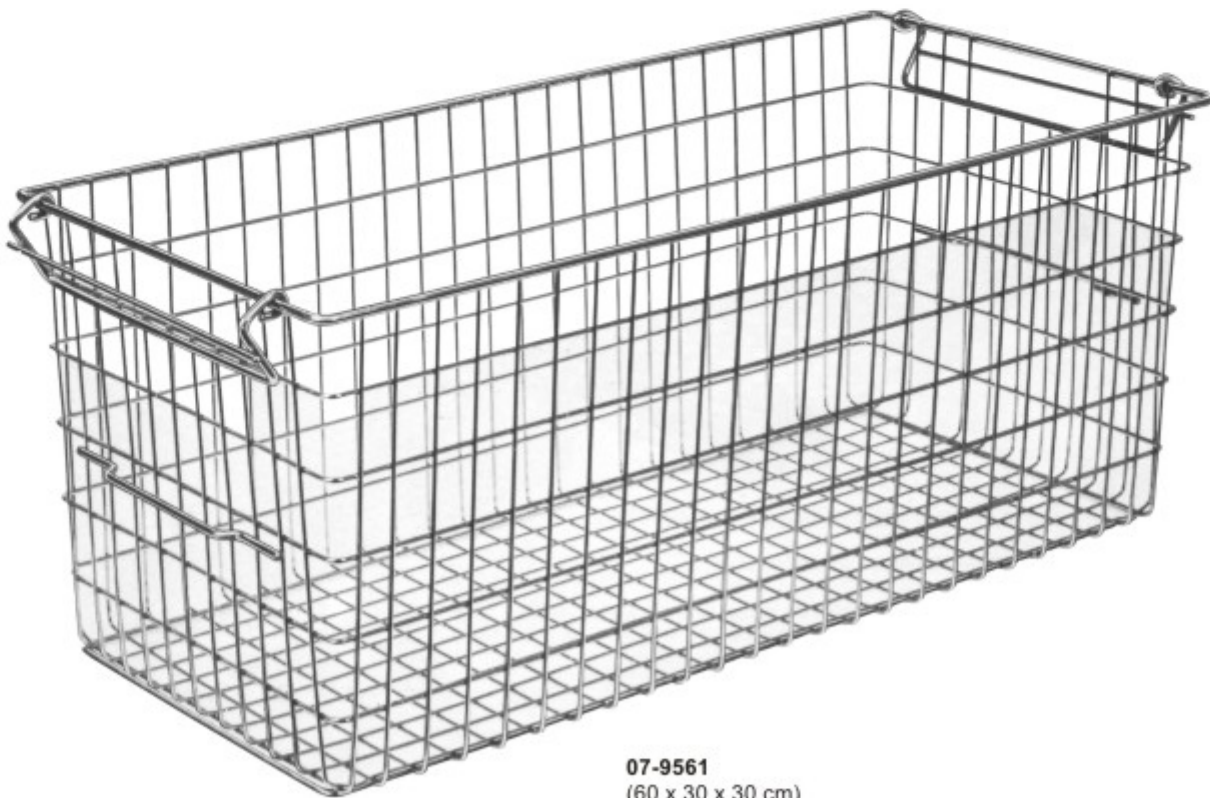

07-9561
(60 x 30 x 30 cm)
Nominal dimensions

ALPHABETICAL INDEX

A

Abdominal Blades	163
Retractors	144-147, 162-164-167
Abraham Tonsil Knife	17
Adson Delicate Haemostatic Forceps	80
Dissecting Forceps	55,62,411
Needle Holders	98
Raspatories	334
Retractors	155-156
Adson-Baby Self-Retaining Retractors	154
Adson-Brown Tissue Forceps	63
Aesthesiometers	1
Alexander Bone Rongeurs	367
Gouges	353
Rib Raspatories	299
Organ Grasping Forceps	74
Retractors	151
Sponge Forceps	68
Allen Intestinal Clamps	173
Allis Artery Traction Forceps	73
Intestinal Grasping Forceps	171
Lung Grasping Forceps	290
Tissue Grasping Forceps	168
Allison Lung Spatulas	138,309
ALY Aesthesiometers	1
Amputation Knives	16,319
Retractors	320
Saws	321-322
Anastomosis Clamps	184-186,265-266, 269-270,275-276, 285-286
Anderson-Adson Retractors	155
Andrew Tongue Depressors	5
Anestophon Stethoscope	2
Angle Wire Cutters	388
Antrum Trocars	208
Anusscopes	189
Aorta Clamps	280-281,288
Aorta-Anastomosis Clamps	282
Aorta-Aneurysm Clamps	278-279
Aorta Cross Clamps	276-277
Aortic Dilators	260
Appendectomy Clamps	182
Apprex Elevating Forceps	235
Arruga Forceps	62
Needle Holders	96,412,413
Artery Traction Forceps	73
Asch Secretion Curette/Scoop	237
Aspiration Curettes	398
Ateriectomy Scissors	34
Aufricht Bone Rasps	339
Austin Micro Forceps	52
Autopsy Knives	13,16
Auricle Clamps	294
Auvard Vaginal Speculums	218
Ayre Cone Knife	17

B

Babcock Intestinal Grasping Forceps	169,171
Lung Grasping Forceps	290
Baby-Adson Forceps	87
Baby-Allis Artery Traction Forceps	73
Baby-Allis Tissue Grasping Forceps	168
Baby-Collin Abdominal Retractors	162
Baby-Crile Delicate Haemostatic Forceps	80
Baby-Kocher Intestinal Clamps	173
Baby-Metzenbaum Scissors	38
Baby-Mikulicz Peritoneum Forceps	91

Baby-Mixer Forceps	87
Baby-Mosquito, Delicate Haemostatic Forceps	79
Baby-Nail Scissors	49
Baby-Overholt Forceps	87
Baby-Roux Retractors	123
Baby-Senn-Miller Retractors	123
Backhaus Towel Clamps	75
Backhaus-Kocher Towel Clamps	75
Bailey Rib Spreaders and Contractors	307
Bainbridge Intestinal Clamps	173
Bakes Common Bile Duct Dilators	198
Balfour Abdominal Retractors	165
Balfour-Baby Abdominal Retractors	164
Bandage Cutting Scissors	49-51,393,394
Bane-Hartmann Bone Rongeurs	366
Barraquer Micro Needle Holders	97,419
Retractors	151
Barth Bone Curettes	342
Bayonet Shaped Forceps	53-54,61
Bumgartner Needle Holders	98
Beckmann-Adson Retractors	156
Beckmann-Eaton Retractors	156
Beebe Wire and Plate Scissors	48
Beer Cilia Forceps	66
Bed Pans	426
Bending Pliers	387
Bengolea Delicate Haemostatic Forceps	81
Bennett Bone Levers	330
Berger Biopsy Forceps	240
Bergh Cilia Forceps	66
Bergmann Mallets	350
Plaster Scissors	394
Trachea Retractors	118
Berliner Percussion Hammer	1
Bertillon Caliper for Head	11
Bethune Rib Shears	296
Beyer Bone Rongeurs	367
Biemer Curettes for Aspiration Lipectomy	398
Vein Scissors	24
Bier Amputation Saws	322
Bircher Meniscus and Cartilage Forceps	377
Bircher-Ganske Meniscus & Cartilage Forceps	377
Biopsy Curettes	237
Forceps	238-240
Forceps For Rectum	190-191
Biopsy Instruments	237-240
Tips	240
Bioptome	260
Bishop-Harmon Forceps	62
Blade Breakers	19
Bladder Retractors	204
Spatula	204
Blake Embolus Grasping Forceps	257
Gall Duct Dilators	198
Gall Stone Forceps	199
Uterine Curettes	242
Blood Lancet	7
Blumenthal Bone Rongeurs	366
Bohler Bone Cutting Forceps	374
Bone Rongeurs	368
Traction Bows	382
Bonaccolto Forceps	55
Bone Clamps	364
Curettes	342-347
Cutting Forceps	297,373-376
Files	399-341
Holding Forceps	358-363
Levers	324-330
Rasps	339-341
Retractors	125
Rongeurs	365-372

ALPHABETICAL INDEX

Shears	42	Nerve and Vessel Hooks	116
Bonney Dissecting Forceps	58	Raspatories	335
Tissue Forceps	65	Retractors	130,160
Bose Self-Retaining Retractors	151	Rongeurs	314-316,318
Trachea Retractors	118	Tampers	351
Tracheal Hooks	256	Castaneda Multi Purpose Clamps	265
Bowel Scissors	46	Castroviejo Blade Holder	19
Bowles Stethoscopes	2	Caliper	11
Bowman Probes	109	Micro Spring Scissors	23
Boxes	422	Needle Holders	96,412,413,417,418
Boynnton Needle Holders	101	Tissue Forceps	62
Boys-Allis Artery Traction Forceps	73,168	Castroviejo-Koshima Needle Holders	418
Bozemann Needle Holders	414	Castroviejo-Micro Needle Holders	418
Uterine Dressing Forceps	225,226	Catlin Knife	16
Uterine Scissors	44	Cerclage Instruments	384
Vaginal Speculums	219	Wire Tightner	383
Bozemann-Douglas Uterine Dressing Forceps	226	Chaput Artery Traction Forceps	73,168
Bozemann-Fritsch Uterine Flushing Tube	245	Charging Set	4
Brain Knives	13	Charriere Amputation Saws	321,322
Braun Artery Traction Forceps	73	Cheatle Forceps with Jar	423
Cranioclast	254	Cheek and Lip Retractors	5
Tenaculum Forceps	227	Cheron Sponge Forceps	69
Uterine Depressor	224	Chisels	351-353,355,356
Vaginal Speculums	215	Choledochus Forceps	195
Braun-Stadler Scissors	45,51,248	Cilia Forceps	66
Breisky Pelvimeter	246	Circumcision Clamps	207
Vaginal Speculums	211,217	Citelli Punches	310
Brock Micro Needle Holders	97	Citelli-Beyer Punches	310
Brodie Director	107	Clar Head Light	4
Brom Vein Hook	115	Claus Van Eicken Needle	104
Bronchus Clamps	277	Cleaning Brush	256
Forceps	295	Clip Applying and Removing Forceps	111
Brophy Dissecting Forceps	56	Clip Applying Forceps	111
Tissue Forceps	64	Cloth Scissors	50,51
Brown Forceps	63	Cloward Lamina Spreader	161
Bruenings Extension Cannulae	240	Retractors	159
Tongue Depressor	5	Coagulation Hooks	116
Tonsil Knife	17	Suction Cannulae	404
Brunner Guiding Probes	105,106	Coakley Antrum Trocars	208
Ligature Needles	105	Coarctation Clamps	272,273,288
Retractors	137	Collin Abdominal Retractor	162
Rib Shears	296	Clip Applying Forceps	111
Bruns Bandage and Plaster Scissors	51,394	Druck Pressure	11
Bone Curettes	344	Elevating Forceps	233,235
Bryant Sponge Forceps	67	Intestinal Grasping Forceps	169,171
Buchs Retractors	130	Kidney Elevating Forceps	202
Buchwald Tongue Depressors	5	Organ and Tissue Grasping Forceps	71
Buck Cotton Applicators	110	Ovum Curettes	243
Percussion Hammer	1	Pelvimeters	246
Buck-Gramcko Bone Levers	325	Retractors	123
Buelau Empyema Trocars	208	Rib Shears	296
Bulldog Clamps	77,78	Scalpel Handle	20
Bumm Ovum Curettes	243	Sponge Forceps	69,71
Ovum Forceps	232	Tongue Forceps	6
Uterine Curettes	242	Vaginal Speculums	209
Bunt Safety Pin	76	Collin-Hartmann Retractors	123
Bushe Bone Curettes	345	Combined Suction and Irrigation Cannulae	404
C			
Calipers	11	Comedone Extractors	18
Canad.Modell Meniscus Knives	379	Compression Forceps	94-95
Cardiovascular Scissors	40	Conductors	323
Caroll Caliper	11	Cone Knife	17
Carotid Clamps	294	Contractors	307
Carrel Delicate Haemostatic Forceps	79	Converse Dura and Skin Retractor	117
Cartilage Forceps	377	Needle Holder	98
Knives	13,16	Cooley Aortic Dilators	260
Caspar Bone Curettes	346	Clamps	284-288
Knot tier and Ligature Adjuster	106	Multi Purpose Clamps	266,287
Micro Scissors	24	Sternotomy Spreaders	305
		Cooley-Beck Anastomosis Clamps	284
		Cooper Surgical Scissors	31
		Ligature Needle	104

ALPHABETICAL INDEX

E

Echlin Bone Rongeurs	369
Eiselsberg Ligature Scissors	47
Needle Holders	100
Eiselsberg-Mathieu Needle Holder	101
Elevators	258,299,324, 331-336
Elsching Forceps	62
Embolus Grasping Forceps	257
Emmet Fistula Hooks	121
Sponge and Dressing Forceps	69
Empyema Trocars	208
Endarterectomy Strippers	259
Endospecula For Cervix	223
Engel Plaster Saw	393
Engl. Mod. Towel Clamps	75
Enucleation Scissors	35
Episiotomy Scissors	45,248
Eppendorf Biopsy Forceps	240
Esmarch Bandage & Plaster Scissors	51,394
Plaster Knife	393
Ether Mask	6
Examination and Measuring Instruments	11
Exploration Hooks	116
Extension Cannulae	240
Cord	4
Extraction Pliers	387
Eye Scissors	23

F

Farabeuf Bone Holding Forceps	360
Raspatories	336
Retractors	123
Farabeuf-Lambotte Bone Holding Forceps	360
Farrell Cotton Applicators	109,110
Faure Biopsy Forceps	238
Peritoneum Forceps	91
Favoloro Artery Scissors	39
Feilchenfeld Splinter Forceps	66
Female Catheters Urinary Instruments	206
Femur Retractor	157
Fergusson Bone Holding Forceps	359
Haemorrhoidal Forceps	193
Suction Tube	402
Fergusson-Ackland Mouth Gag	6
Ferris-Smith-Kerrison Punches	312
Fiber Optic Battery Handle	10
Fine Scissors	33,34,410
Finger Nail Drill	392
Nail Instruments	392
Ring Saw	392
Finochietto Dissecting & Ligature Forceps	89,291
Needle Holders	415
Rib Spreaders	300,301
Finochietto-Burford Rib Spreaders	302
Finsen Self-Retaining Retractors	151
Finsterer Combined Cannulae	404
Fishtail Chisel	353
Fistula Hooks	121
Fixation Clamp	380
Discs	381
Flap Knives	16
Flat Nosed Pliers	386,387
Foerster-Ballenger Sponge Holding Forceps	70
Fomon Dissecting Scissors	35
Forceps	60-61
Nasal Scissors	41
Rasps/Bone File	340
Retractors	120

Forceps	52-66
With Tungsten Carbide Inserts	411-412
Ford-Bowles Stethoscopes	2
Foregger Laryngoscopes	10
Fowler Tonsil Knife	17
Francke Blood Lancet	7
Frazier Fine Wound Retractors	117
Suction Tube	402
Freer Chisels	351
Fine Wound Retractors	117
Gouges	351
Raspatories	332,333
Vascular Spatulas	258
Freer-Yasargil Raspatories	333
Frenzel Tongue Depressors	5
Fricke Artery Forceps	58,82
Fritsch Retractors	146

G

Gall Bladder Forceps	196
Trocars	208
Gall Duct Dilators	198
Forceps	194-195
Probes	197
Scissors	196
Gall Stone Forceps	199
Scoops	198
Gallaher Bone File	339
Gastro-Intestinal Forceps	181
Gauss Scalp Flap Forceps	251
Gelpi Retractors	157
Vaginal Retractors	220
Genito-Urinary Instruments	205-207
Gerald Dissecting Forceps	56
Tissue Forceps	64
Gerster Bone Clamps	364
Giertz- Stille Rib Shears	296
Gigli Wire Saws and Handle	323
Gill Forceps	62
Gill-Hess Forceps	62
Gillies Fine Wound Retractors	117
Needle Holders	100
Tissue Forceps	64
Glass Rods	236
Glover Anastomosis Clamps	269,270
Bulldog Clamps	78
Vena Cava Clamps	270
Gluck Rib Shears	296
Goldmann-Fox Scissors	410
Good Tonsil Scissors	41
Gorney Suction Dissector	402
Gosset Abdominal Retractors	164
Gouges	351-353,355-356
Graduated inside	425
Graefe Fine Wound Retractors	117
Knives	14
Nerve and Vessel Hooks	115
Tissue Forceps	63
Grave Vaginal Speculum	211
Gray Forceps	90,195
Green-Armytage Obstetrics Forceps	251
Gross Sponge Forceps	67
Gruenwald Forceps	61
Guedel-Negus Laryngoscopes	9
Guide	259
Guiding Probes	105,106
Guthrie Fine Wound Retractors	117
Guyon Catheter Guide	206

ALPHABETICAL INDEX

Kidney Clamps	200
Urethral Bougies	206-207
Gynaecological Instruments	245
Scissors	43-44
H	
Haase Tamper	351
Reposition Forceps	357
Haberer Intestinal Spatulas	150
Haemostatic ATRAUMATA Forceps	267,268
Haemostatic Forceps	70,79-86,92
Haemorrhoidal Forceps	192-193
Hajek Irrigation Cannula	197
Mallets	349
Hajek-Kofler Punches	311
Halogen Replacement Lamp	10
Halle Bone Curettes	345
Raspatories	332
Vascular Spatulas	258
Halsey Needle Holder	98,413
Halsted Delicate Forceps	80,81
Halsted-Mosquito Delicate Forceps	79,81
Handles	7,20,21,137,215, 219,240,259,261, 323,399
Harken Vena Cava Clamps	293
Hartmann Intestinal Clamps	174
Harvey Wire Cutting Scissors	48,388
Harrington Retractors	138
Harrington-Pemberton Retractors	308
Head Bands	3
Lights	4
Mirrors	3
Heaney Hysterectomy Forceps	92,93
Needle Holders	415
Heaney (Hegar) Needle Holders	99
Heath Clip Removing Forceps	111
Mallet	350
Hebra Comedone Extractors	18
Hegar Needle Holders	99,413
Uterine Dilators	221-222
Hegar-Olsen Needle Holders	100
Hegar-Vascular Needle Holders	413
Hegenbarth Clip Applying Forceps	111
Heiss Delicate Haemostatic Forceps	81
Ligature Forceps	89
Heister Mouth Gag	6
Hemingway Bone Curettes	343
Hennig Plaster Spreader	397
Hepp-Scheidle Needle Holders	412
Herberhold Pocket-Accu	4
Herff Membrane Puncturing Forceps	247
Herget Biopsy Forceps	190
Herrick Kidney Pedicle Clamps	201
Hertzler Retractors	164
Rib Spreaders	300
Herz Tendon Seizing Forceps	72
Hess Forceps	62
Hey Groves Bone Holding Forceps	362
Heymann-Knight Nasal Scissors	41
Heywood-Smith Gall Bladder Forceps	196
Haemorrhoidal Forceps	192
Ovum Forceps	231
Sponge Holding Forceps	71
Tongue Forceps	6
Hoepfner Vessel Clamps	292
Hohmann-Aldinger Bone Levers	329
Holzbach Abdominal Retractor	162
Hopkins Plaster Instruments	393
Hose Connection	244

Hosel Retractors	131
Hosemann Choledochus Forceps	195
Hospital Wares	422-432
House Irrigation Cannulae	404
Howarth Raspatories	333
Huber Handle	240
Hunt Tumor & Vessel Forceps	54
Hunter Splinter Forceps	66
Hurd Ligature Needles	104
Hysterectomy Forceps	92-94

I	
Incision Surgical Scissors	32
Inge Lamina Spreaders	161
Instrument Boxes	422,423
Instruments for Micro Tubal Operation	236
Interosseous Knife	16,319
Intestinal Clamps	173-180
Forceps	65,168-171
Spatulas	149-150
Intestinal And Pylorus Clamps	183
Iowa Membrane Puncturing Forceps	247
Irrigation Cannulae	257,404
Israel Retractors	127
Ives-Fansler Anusscopes	189

J	
Jackson Tendon Seizing Forceps	72
Tracheal Tubes	255
Vaginal Speculums	214
Jackson Burrows Retractors	157
Jacobs Tenaculum Forceps	230
Jacobson Bone Curettes	342
Needle Holder	96,419
Jaeger Fine Wound Retractors	117
Jager Tendon Seizing Forceps	72
Jameson Dissecting Scissors	34
Needle Holder	99
Jansen Bone Curettes	342,343
Bone Rongeurs	366,367
Forceps	61
Head Light with Plastic Band	4
Raspatories	336
Retractors	151
Jars	423,424
Jenkner Instrument set for Tunnelling and Pulling-through Vascular Grafts	261
Jeweler Forceps	52
Bulldog Clamps	77
Joll (Friedman) Retractors	157,220
Jones Towel Clamps	75
Jonesco Ligature Needles	104
Jordan Instruments	385
Joseph Bone File	339
Delicate Scissors	29
Fine Wound Retractors	117
Nasal Knives	18
Raspatories	331
Judd-Allis Tissue Grasping Forceps	168
Judd-Masson Bladder Retractors	204

K	
Kader Intestinal Spatula	149
Kalt Needle Holders	96,417

ALPHABETICAL INDEX

Kazanjian Bone Cutting Forceps	373	Lahey (Sweet) Dissecting and Ligature Forceps	90
Kelly Delicate Forceps	79	Gall Duct Forceps	194
Delicate Scissors	29	Lambotte Bone Holding Forceps	363
Obstetrical Forceps	254	Osteotomes	353,354
Ovum Forceps	231	Rib Raspatories	299
Proctoscopes	189	Lamina Spreaders	161
Retractors	133,145	Laminectomy Retractors	155,156,158
Sphincteroscopes	189	Landolt Coagulation Suction Cannulae	404
Sponge Holding Forceps	71	Enucleation Scissors	35
Kern-Lane Bone Holding Forceps	361	Raspatories	335
Kerpel Bone Curettes	343	Suction Cannulae	403
Kerrison Punches	311	Lane Bone Holding Forceps	361,362
Kerrison-Jacoby Punches	312	Bone Levers	326
Kersting Anastomosis Forceps	186	Intestinal Forceps Twin	181
Kidney Clamps	200-201	Intestinal Grasping Forceps	170
Dishes	425	Tissue Forceps	65
Elevating Forceps	202	Towel Clamps	75
Stone Forceps	203	Lane Trethowan Bone Levers	326
Killian Bone Shears	42	Lange Fistula Hooks	121
Probes	109	Lange-Hohmann Bone Levers	326
Raspatories	333	Langenbeck Amputation Saws	322
Rectal Specula	187	Bone Holding Forceps	359
Kilner Dissecting Scissors	34,410	Bone Levers	324
Fine Wound Retractors	117	Elevators	324
Needle Holder	98	Flap Knife	16
Kirschner Guiding Probes	106	Head Light	4
Retractors	167	Needle Holders	416
Wire Traction	380,381	Raspatories	336
Kirschner-Balfour Blade	167	Resection Knives	14,319
Klapp Tendon Hooks	121	Retractors	128
Kleinschmidt Spur Crusher	182	Rib Raspatories	299
Klima Rosegger Sternal Puncture Needle	208	Langenbeck-Green Retractors	120
Knives	12-14,16-18, 319	Langenbeck-Mannerfelt Retractors	119
Knot tier and Ligature Adjuster	106	Langhals Needle Holders	416
Knowles Bandage Scissors	49	Laryngeal Mirrors	7
Kocher Bladder Spatulas	204	Laryngoscopes	9,10
Bone Retractors	125,126	Lathbury-Farrell Cotton Applicators	109,110
Guiding Probes	106	Lawrence Forceps	89
Haemostatic Forceps	84	Lazar Micro Forceps	52
Intestinal Clamps	175,177,178	Lebsche Conductor for Wire Saws	323
Retractors	122,125,126, 129,130	Sternum Chisels	296
Suture Needles	104	Lees Bronchus Clamps	277
Kocher-Langenbeck Retractors	128	Legueu Bladder Retractors	204
Kocher-Ochsner Haemostatic Forceps	85	Bladder Spatula	204
Koenig Guiding Probes	106	Leksell-Stille Bone Rongeurs	370
Elevators	324	Leland-Jones Peripheral-Vascular Clamps	274,275
Raspatories	331	Lempert Bone Curettes	345
Retractors	122	Bone Rongeurs	367
Koerte Retractors	127	Lerliche Intestinal Spatula	149
Kogan Endospecula	223	Lewis Bone Rasps	339
Kolle Micro Needle Holders	7	Lewkowitz Ovum Forceps	253
Konrich Sterilizing Drums	422	Lexer Gouges	355,356
Krause Biopsy Tips	240	Osteotomes	355,356
Krayenbuhl Nerve and Vessel Hooks	116	Scissors	37,406
Kristeller Vaginal Speculums	211-214	Lexer-Mini Gouges	355
Kronecker Ligature Needles	103	Osteotomes	355
Kronlein Haemostatic Forceps	82	Lichtenberg Needle Holders	416
Krypton Replacement Lamp	10	Ligature Adjuster	106
Kuhne Cover Glass Forceps	55	Forceps	53,58,87-90, 269,291-292
Kummel Intestinal Spatula	149	Needles	103-105
Kustner Tenaculum Forceps	229	Pliers	386
		Scissors	47
		Lister Bandage Scissors	50
		Sinus Forceps	67
		Liston Bone Cutting Forceps	373,375
		Knife	16
		Liston-Key-Horsley Bone Cutting Forceps	297,376
		Liston-Stille Bone Cutting Forceps	297,376
		Littauer Ligature Scissors	47
		Littler Dissecting Scissors	33
Laborde Tracheal Dilators	256		
Lahey Artery Traction Forceps	73		
Gall Duct Forceps	194		
Tenaculum Forceps	228		

L

ALPHABETICAL INDEX

Littlewood Tenaculum Forceps	230
Liver Retractor	145
Lloyd-Davis Sigmoid Anastomosis Forceps	185
Lloyd-Davies Rectal Scissors (Goligher's)	46
Lockhart-Mummery Probes	107
Locklin Scissors	41
Lockwood Intestinal Grasping Forceps	169
Logan modif. Reill Self-Retaining Retractors	151
Lopez-Reinke Tonsil Dissector	402
Lorna Towel Clamps	76
Loute Wire Tightener	383
Love-Gruenwald Rongeurs	314,316,317
Lower Forceps	90,194
Lowman Bone Clamps	364
Lowman-Gerster Bone Clamps	364
Lowman-Hoglund Bone Clamps	364
Lucae Forceps	61
Lucas Bone Curettes	343
Chisels	352
Gouges	352
Luethy-Beck Needle Holders	416
Luer Bone Rongeurs	366,368
Haemorrhoidal Forceps	192
Retractors	123
Tracheal Tubes	255
Luer-Friedmann Bone Rongeurs	365
Luer-Koerte Gall Stone Scoops	198
Luer-Stille Bone Rongeurs	371,372
Lung Dissecting Forceps	65
Grasping Forceps	290
Spatulas, Retractors	138-143,308-309
Luxation Lever	330

M

Mac Donald Raspatories	333
Magill Forceps	8
Maier Sponge Forceps	68
Maltz Bone Rasps	339
Mallets	348-350
Mannerfelt Osteotomes	351,352
Raspatories	334
Retractors	119
Markwalder Rib Rongeurs	297
Marquardt Bone Rongeurs	368
Martin Meniscus and Cartilage Forceps	377
Needle Holders	414
Pelvimeters	246
Retractors	135
Tenaculum Forceps	228
Uterine Probes	224
Vaginal Speculums	218
Martini Bone Curettes	342
Masing Retractors	122
Masson Needle Holders	99
Masson-Luethy Needle Holders	99
Mathieu Foreign Body Forceps	205
Needle Holders	101,415
Rectal Specula	188
Retractors	124
Vaginal Speculums	215
Mathieu-Kocher Needle Holders	415
Mathieu-Ryder Needle Holders	416
Mathieu-Stille Needle Holders	101
Mathieu-Vascular Needle Holders	415
Mayo Gall Duct Probes	197
Safety Pin	76
Scissors	35-37,408
Uterine Probes	224

Mayo-Adams Retractors	154
Mayo-Harrington Scissors	36,409
Mayo-Hegar Needle Holders	99,413
Mayo-Lexer Scissors	37,406
Mayo-Noble Scissors	36
Mayo-Robson Intestinal Clamps	180
Mayo-Stille Scissors	35,36,406
Mc Indoe Forceps	56
Tissue Forceps	64
Mc Kenty Raspatories	331
Mcintosh Laryngoscopes	10
Mead Bone Rongeurs	367
Mallets	348
Raspatories	333
Measuring Instruments	11
Medicine Cups	424
Spoons	424
Membrane Puncturing Forceps	247
Meniscus Knives	378,379
Forceps	377
Mercedes Retractor	306
Metacarpal Saw	322
Metal Cups	424
Round Boxes	424
Methot Pot	426
Metzenbaum Dissecting Scissors	26,38,407,408
Metzenbaum-Fino Dissecting Scissors	407,408
Meyer Reposition Forceps	357
Meyerding Retractors	120,134
Michel Clip Applying and Removing Forceps	111
Rhinoscopic Mirrors	7
Micro Dissecting Scissors	23-25
Dissecting Scissors Bayonet	25
Forceps	52,53
Jeweller Types Forceps	52
Ligature Forceps Bayonet	53-54,87
Needle Holders	96-97,420
Suture Tying Forceps	52
Micro-2000 Needle Holders	420
Micro-Adson Forceps	55,62,87
Micro-Halsted Delicate Forceps	79
Microscopic Forceps	55
Middeldorpf Retractors	130
Mikulicz Forceps	86
Intestinal Spatula	149
Peritoneum Forceps	91
Retractors	144,145
Milium Knives	18
Miller Laryngoscopes	9
Rasps	340
Millin Bladder Neck Spreader	205
Bladder Retractors	204
Center Blade for Retractors	204
Ligature Holding Forceps	101
Lobe Grasping Forceps	205
Mills Gall Duct Scissors	196
Mirror Handles	7
Mirrors for Head light	4
Mixer Dissecting and Ligature Forceps	89,90,292
Gall Duct Forceps	195
Mixer-O'Shaughnessy Forceps	89
Modell Piccolo Cotton Applicators	109
Mod. USA Plaster Spreader	397
Modell Tubingen Retractors	135
Mollison Self-Retaining Retractors	154
Molt Raspatories	333
Moeltgen Goniometer	11
Moncorps Milium Knives	18
Mosquito Atraumata Forceps	267
Morris Anastomosis Clamps	186
Ascending Aorta Cross Clamps	276

ALPHABETICAL INDEX

Retractors	133
Morse Sternotomy Spreaders	304
Mouth Gags	6
Moynihan Forceps	86
Gall Stone Probes	197
Intestinal Clamps	179
Muehling Raspatories	335
Mueller Retractors	151
Mullar claus Wire cutting Plier with T.C	421
Multi-Purpose Clamps	283,286-287,289
Muller Fine Wound Retractors	117
Ligature Forceps	77
Micro Forceps	53
Micro Needle Holders	97
Vessel Clips	77
Murphy Head band	3
Murphy-Lane Luxation Levers	330
Museux Artery Traction Forceps	73
Tenaculum Forceps	230
Myoma Instruments	236
Screws	236
Myomatome	17,236
Myrtle Leaf Probes	108

N

Naegele Obstetrical Forceps	249
Nagel Micro Scissors	25
Nail Extraction Forceps	392
Scissors	49
Splitting Forceps	32,392
Nasal Scissors	41
Suction Tubes	402
Naujoks Wire Scissors	48
Needle Cases	422,428
Needle Holders	7,96-101
Needle Holders With Tungsten Carbide Inserts	412-416
Needle Sterilizing Cases	427
Neff Meniscus Knives	378
Negus Tonsil Forceps	86
Nelaton Directors	107
Nelson Lung Dissecting Forceps	65
Lung Grasping Forceps	290
Trocars	208
Nelson-Metzenbaum Dissecting Scissors	38
Nerve and Vessel Hooks	115-116
Neubuser Tubal Seizing Forceps	236
Neuro-Surgery Scissors	40
Nissen Dissecting and Ligature Forceps	87
Gall Duct Forceps	194
Non-Traumatic Haemostatic Forceps	267,268
Norfolk and Norwich Retractors	155
Noto Ovum Forceps	231
Sponge Holding Forceps	71
Novak-Schoeckaert Endometrial Biopsy Curettes	237
Noyes Micro Spring Scissors	23
Nurse's Scissors	50
Nussbaum Intestinal Clamps	179

O

Obstetrical Forceps	247,249,250-254
Pelvimeters	246
Scissors	45,248
Obstetric Instruments	246-254
Ochsner Aorta Clamps	281
Gall Duct Probes	197
Ligature Forceps	58
Trocars	208
Oehler Dissecting Forceps	412

Oldberg Rongeurs	317
Olivecrona Bone Rongeurs	368
Dura Scissors	40
Trigeminal Knife	17
Wire Saws	323
Ombredanne Mallets	350
Operating Scissors	43,44,405
Organ and Grasping Forceps	70,71,74,170,171
Osteotomes	351-356
Osteophyte Rongeurs	318
Otoscope Complete Set	8
Battery Handle	8
Overholt Dissecting and Ligature Forceps	88
Overholt-Geissendoerfer Dissecting and Ligature Forceps	88
Overholt-Mixter Dissecting and Ligature Forceps	87
Ovum Curettes	243
Ovum Forceps	231,232

P

Parker Retractors	123
Parker-Kerr Anastomosis Clamps	184
Parry-Cooley Aorta Clamps	288
Partsch Chisels	352
Gouges	352
Raspatories	331
Partsch Mod.Lange Raspatories	331
Passow Tamper	351
Patent-Ductus Clamps	273,288
Patella Forceps	358
Paulsen Raspatories	332
Payr Guiding Probes	106
Intestinal and Pylorus Clamps	183
Pean Haemostatic Forceps	82-84,86
Haemostatic Forceps Atraumata	268
Kidney Clamps	86,200
Pederson Vaginal Speculums	211
Pedicle Clamps	201
Peet Splinter Forceps	66
Pelkmann Uterine Dressing Forceps	225
Pelvimeters	246
Pelvis Retractors	148
Pennington Forceps	70
Percy Amputation Retractors	320
Perforator	254
Perkins Retractors	153
Peripheral-Vascular Clamps	274-275
Percussion Hammers	1
Periosteum Knife	319
Peritoneum Forceps	91
Pertuiset Carotid Clamps	294
Phalangeal Knife	319
Phaneuf Hysterectomy Forceps	92
Piccolo Cotton Applicators	109
Pierce Antrum Trocars	208
Pinard Stethoscopes	2
Placenta and Ovum Curettes	243,252-254
Placenta Pan	427
Plaster Breakers	397
Instruments	393
Knives	393
Saw	393
Scissors	51,394
Shears	395,396
Spreaders	397
Plester Retractors	153
Suction Tube	402
Pliers For Bending and Cutting Wires	387
Pocket Instrument Set	112-113

ALPHABETICAL INDEX

Polyaethylen Splint Material	236
Polypus and Ovum Forceps	231,232
Pool Suction Tube	400
Post Mortem Knives	13
Potts-De Martel Gall Bladder Scissors	196
Potts-Smith Forceps	412
Needle Holders	412
Scissors	39,40,410
Powder Pot	427
Strewer	427
Pozzi Tenaculum Forceps	227
Pratt Organ Grasping Forceps	74
Rectal Specula	188
Pressure Clamps	94,184,193,276
Price Thomas Bronchus Forceps	295
Probes	106-109,385
Proctoscopes	189
Protection Caps (Steinmann Pins)	382
Providence-Hospital Delicate Forceps	79
Punches	310-312
Putti Bone File	341

Q

Quervain Bone Levers	324
Quinby Delicate Scissors	29

R

Rabiner Percussion Hammer	1
Ragnell Scissors Flat Point	26,410
Rampley Sponge Holding Forceps	70
Randall Endometrial Biopsy Curettes	237
Kidney Stone Forceps	203
Rankin Delicate Forceps	80
Raspatories	331-338
Rasps	339-341
Razors	22
Blade Holders	19
Recamier Ovum Curettes	243
Uterine Scoops	241
Rectal Scissors	46
Speculas	187-188
Reill Cutting Pliers	389
Drilling Chucks	383
Reposition Forceps	357
Replacement Lamps	10
Reposition Forceps	357,358
Resection Knives	14,319
Retractors	5,117,148,151-160,
	164-167,308
For Cervical Spine	159,164,167
For Cervical Vertebral Column	160
For Deep Surgery	134-135,144-145
With Treangle Handles	119
Reverdin Intestinal Spatula	150
Needles	102
Reynolds Dissecting Scissors	34
Rib Holding Forceps	297
Raspatories	298-299
Rongeurs	297
Shears	296
Spreaders	300-303,307
Ricard Abdominal Retractors	162
Richardson Retractors	132
Richardson-Eastman Retractors	132
Richter Vaginal Retractors	220
Ring Handle Bulldog Clamps	264,284
Robin Towel Clamps	76

Rochard Retractors	147
Rochester-Carmalt Haemostatic Forceps	86
Rochester-Ochsner Haemostatic Forceps	84
Rochester-Pean Haemostatic Forceps	83
Roeder Towel Clamps	75
Rohrschneider Needle Holder	96
Rollet Fine Wound Retractors	117
Rongeurs	313-318
Rose Retractors	123
Roser-Koenig Mouth Gag	6
Roettgen-Ruskin Bone Rongeurs	369
Round Bowls	426
Handle Needle Holders	97
Metal Boxes	425
Pliers	387
Roux Retractors	124
Rudd Haemorrhoidal Ligators	193
Rulers	11
Rumel Forceps	89
Rumel-Belmon Tourniquets	259
Ruskin Bone Rongeurs	369
Ruskin-Liston Bone Cutting Forceps	374
Russ-Modell Tissue Forceps	65
Rust Amputation Saws	321
Ryder Needle Holders	414
Ryder-Vascular Needle Holders	414

S

Saalfeld Knife	18
Saddle Hooks	119
Saenger Ovum Forceps	252,253
Safety Pins	76
Salenius Meniscus Knives	379
Salpingograph	260
Samii Tissue Grasping, Tumors Forceps	54
Sarot Needle Holders	414
Satinsky Anastomosis Clamps	293
Scissors	40
Satterlee Amputation Saws	322
Sauerbruch Retractors	129
Sterilizing Cases	428
Sauerbruch-Coryllos Rib Rongeurs	297
Saupe Cilia Forceps	66
Scalp Flap Forceps	251
Scalpel Handles	20,21
Knives	14,15,18
Scaphoid Gouges	351
Scapula Retractors	139,308
Schaaf Cilia Forceps	66
Schaedel Towel Clamps	75
Schede Bone Curettes	344
Scheinmann Biopsy Tip	240
Scherback Vaginal Speculums	219
Schimmelbusch Ether Mask	6
Sterilizing Drum	422
Schink Dermatomes	22
Schmid Irrigation Cannulae	257
Vascular Spatula	258
Schmieden Guiding Probes	106
Schmieden-Dick Ligature Needles	105
Schneider Pelvimeters	246
Raspatories	336
Schoemaker-Loth Needle Holder	100
Ligature Scissors	47
Schoenborn Retractors	122
Schroeder Organ Grasping Forceps	74
Tenaculum Forceps	227-229
Uterine Scoops	241
Schubert Biopsy Forceps	238

ALPHABETICAL INDEX

Schulz Bioptome	260	Spurling Rongeurs	314,316,317
Schulze Salpingograph	245	Sputum Cup	425
Schumacher Biopsy Forceps	239	St. Marks Retractors	148
Biopsy Tips	240	St. Martin Forceps	62
Bone Levers	329	Stacke Probes	109
Sternum Shears	296	Stamm Bone Cutting Forceps	373
Umbilical Cord Scissors	45,248	Standard Dissecting Forceps	57
Schumacher mod. Wagner Bone Levers	329	Scissors	30,31,405
Schwarz Traction Bows	382	Tissue Forceps	63
Scissors	23-51	Steinmann Pins	382
With Tungsten Carbide Inserts	405-411	Stellbrink Bone Rongeurs	365
Scoville-Richter Self-Retaining Retractors	158	Stelzner Rectal Scissors	46
Screw Driver	381	Sterilizing Baskets/Trays	431,432
Scudder Stomach Clamps	182	Cases	430
Sedillot Raspatories	336	Drums	422
Segond Myomatome	17,236	Forceps	55,424
Seidl DBP Biopsy Forceps	239	Sternal Puncture Needle	208
Vaginal Specula	211	Sternberg Cheek and Lip Retractor	5
Seiffert Probes	109	Retractors	123
Self Centering Forceps	363	Sternum Instruments	296
Self Retaining Retractors	151-156,158	Sternotomy Spreaders	304-305
Laminectomy Retractors	155-156	Stethoscopes	2
Sellers Rib Spreader and Contractor	307	Stevens Dissecting Scissors	26,33
Semb Bone Holding Forceps	297,360	Needle Holders	417
Bone Rongeurs	372	Stieglitz Splinter Forceps	66
Dissecting and Ligature Forceps	291	Stille Bone Rongeurs	370
Rib Raspatories	299,337	Chisels	353
Rib Rongeurs	297	Dissecting Scissors	37
Semken Delicate Forceps	56,62,411	Gouges	353
Semm Abdominal Retractors	166	Kidney Clamps	201
Vaginal Specula	210	Osteotomes	353,354
Senn-Miller Retractors	123	Plaster Shears	395,396
Sequestrum Forceps	359	Stille-Barraya Dissecting Forceps	170
Seutin Plaster Scissors	51,394	Stille-Ruskin Bone Rongeurs	370
Sewall Raspatories	332	Stomach Clamps	182
Seyffert Vaginal Specula	210	Storing Cases	422,429,430
Siebold Uterine Scissors	44	Strack Scissors	48
Sigmoid Anastomosis Forceps	185-186	Strainer for Tissues	244
Silicone Operating Pad	236	Stratte Needle Holders	414
Silver Dermatomes	22	Strassburger Tissue Forceps	65
Simon Bone Curettes/Scoops	241,346	Strassmann Elevating Forceps	234
Fistula Hooks	121	Strully Scissors	40
Retractors	121,135	Subrammanian Aorta Clamps	280
Uterine Scoops	241	Suction Cannula	309,400,401,404
Wound Retractors	218	Curettes	244
Simplex Cheek and Lip Retractor	5	Handles	399
Simpson Obstetrics Forceps	250	Hose Connection	244
Uterine Probes	224	Instruments	309,398-404
Simpson-Braun Obstetrics Forceps	249,250	Raspatories	402
Sims Gynaecological Scissors	43,409	Tubes	309,400-404
Rectal Specula	187,188	Surgical Scissors	30-32,405
Uterine Curettes	242	Suture Hook	106
Uterine Probes	224	Instruments	102-104
Vaginal Specula	211	Scissors	411
Sims-Maier Sponge Forceps	69	Suture Instrument Sets	112
Sims-Siebold Uterine Scissors	44	Swab Holder	191
Skin Retractors	117	Swedish Pattern Forceps	58
Smellie Perforator	254	Syme Suture Needle	104
Smillie Meniscus Knives	379	Synovectomy Rongeurs	365
Smith Bandage Scissors	49	Sypert Bone Curettes With Hartpress Handle	347
Somer Elevating Forceps	234	Systrunk Nail Splitting Scissors	32,392
Spatulas	109		
Special Bone Levers	330		
Retractors	157		
Spencer Ligature Scissors	47		
Spencer-Wells Haemostatic Forceps	83		
Sphincteroscopes	189		
Splint Guide	236		
Splinter Forceps	66		
Sponge Forceps	67-71		
Holding Forceps	70-71		

T

Tablet Tray	425
Tager Special Bone Levers	330
Takahashi Rongeurs	313
Tampers	351
Tangential Occlusion Clamps	271-272
Taylor Percussion Hammer	1

ALPHABETICAL INDEX

Teale Tenaculum Forceps	229
Tendon Hooks	121
Interlacing Forceps	72
Seizing Forceps	72
Tenotomes	14-15
Tessier Bone Curettes	346
Thole Pelvimeter	246
Thoms-Gaylor Biopsy Forceps	238
Thoracic Retractors	306
Thorek Scissors	40
Thorpe Corneal Forceps	55
Thyroid and Vaginal Retractors	157,220
Tiemann Organ Grasping Forceps	74
Tissue Forceps	62-65
Grasping Forceps	54,70,71,73,74, 168,170,171
Tobold Tongue Depressor	5
Toennis Dissecting Scissors	34
Fine Wound Retractors	117
Needle Holders	100
Vascular Spatulas	258
Toennis Wire cutting Plier with T.C	421
Toennis-Adson Dissecting Scissors	34
Tongue Depressors	5
Forceps	6
Tourniquets	259
Tonsil Dissector	402
Forceps	86
Knives	17
Scissors	41
Towel Clamps	75,76
Townley Caliper	11
Trachea Retractors	118
Tracheal Dilators	256
Hooks	256
Tubes	255
Traction Bows	382
Hooks	380
Transformer	4
Transparent Suction Hose	244
Trays	426,430
Trelat Raspatories	331
Triangular Basins	427
Trigeminal Knife	17
Trocars	208,398,399
Troeltsch Forceps	61
Troemner Percussion Hammer	1
Trousseau Tracheal Dilators	256
Troutman-Chris Blade Holder	19
Tubal Seizing Forceps	236
Tubbs Aortic Dilators	260
Tuffier Intestinal Spatula	150
Rib Spreaders	300
Tissue Grasping Forceps	168
Tungsten Carbide Instruments	405-419
Tunnelling Instruments	261
Turnable Biopsy Forceps	190
Tuttle Lung Dissecting Forceps	65
Lung Grasping Forceps	290

U

Ueckermann-Denker Cryothyrotomy Trocar	255
Uffenorde Bone Curettes	343
Ultra-Light Forceps	59,172,262
Umbilical Cord Scissors	45,248
Universal Bandage Scissors	50
Handle	240
Trays	430
Trocars	208
Wire Cutting Scissors	48,388,411

Unna Extractor	18
Ureter Forceps	205
Urethral Bougies Urinary Instruments	206
Uterine Curettes	241,242
Depressor	224
Dilators	221,222
Dressing Forceps	225,226
Elevating Forceps	233-235
Flushing Tube	245
Probes	224
Scissors	43,44,409
Scoops	241
Secretion Scoop	237
Tenaculum Forceps	227-230
US-Army Retractors	124

V

Vacuum Curettes	244,398
Vaginal Clamps	93-94
Retractors	157,217,218,220
Speculas	209-219
Vaginal and Wound Retractors	218
Van Buren Bone Holding Forceps	359
Vannas Micro Spring Scissors	23,24
Vario Retractors	136,137,215
Vascular Dilators	257
Spatulas	258
Vein Retractors	122
Vena Cava Clamps	270,271,293
Venae Sectio Set	113-114
Verbrugge Bone Holding Forceps	363
Verbrugge-Muller Bone Levers	328
Vernier Caliper	11
Vessel Clamps	292
Hooks	115,116
Irrigation Cannulae	257
Scissors	39
Vidal Lupus Scraper	18
Virchow Knife	13
Vise Grip Pliers	387
Micro Forceps	52
Volkman Bone Curettes	342,344
Bone Retractors	125,126

W

Wachenfeldt Clip Applying Forceps	111
Wagener Vessel Hooks	115
Wagner Bone Levers	327
Mallets	349
Meniscus Knives	378
Raspatories With Hartpress Handle	338
Rongeurs	318
Walb Knife	13
Walter Gouges	353
Wangensteen Forceps	412
Intestinal Grasping Forceps	170
Needle Holders	99
Wartenberg Pinwheel	1
Waugh Tissue Forceps	64
Weber Aorta-Anastomosis Clamps	282
Webster Needle Holders	98
Wecker Eye Scissors	23
Weil-Blakesley Rongeurs	313
Weissbarth Vaginal Speculum	217
Weitlaner Self-Retaining Retractors	152-153
Weller Meniscus and Cartilage Forceps	377
Wertheim Anastomosis Clamps	275

ALPHABETICAL INDEX

Clamps and Forceps	92-95,201
Gynaecological Scissors	43
Hysterectomy Forceps	92
Parametrium Clamps	93
Wertheim-Cullen Clamps and Forceps	95
Wieder Tongue Depressor	5
Wiener Modell Suture Hooks	106
Wikstroem Dissecting and Ligature Forceps	291
Wilde Forceps	61
Willett Scalp Flap Forceps	251
Williams Intestinal Grasping Forceps	170
Lung Grasping Forceps	290
Williger Bone Curettes	342,344
Elevators	324
Raspatories	331
Retractors	120
Winter Ovum Forceps	252
Wire Catcher	385
Cutters	388
Cutting Pliers	387,389,391,421
Cutting Scissors	48,388,411
Extentions	380,381
Guides	384
Holding Forceps	386,387
Saws	323
Tightener	380,383,385
Tightening Pliers	386
Traction Bow	380,381
Twister	385
Winkelmann Circumcision Clamps	207
Wolff Plaster Breakers	397
Wound Retractors	117-118,122
Wound and Tracheal Hooks	256
Wrenches	380
Wrigley Obstetrics Forceps	250
Wullstein Self-Retaining Retractors	153
Suction Tube	403

Y

Yankauer Suction Cannulae	309,401
Yasargil Ligature Forceps	53,87
Micro Forceps	53
Micro Needle Holders	96,97,420
Micro Scissors Bayonet Shape	25
Rongeurs	317
Suction Cannulae	309,403,404
Tumor & Vessel Forceps	54

Z

Zenker Forceps	89
Retractor	139
Ziegler Head band	3
Head Mirror	3
Milium Knives	18
Zielke Gouges	335

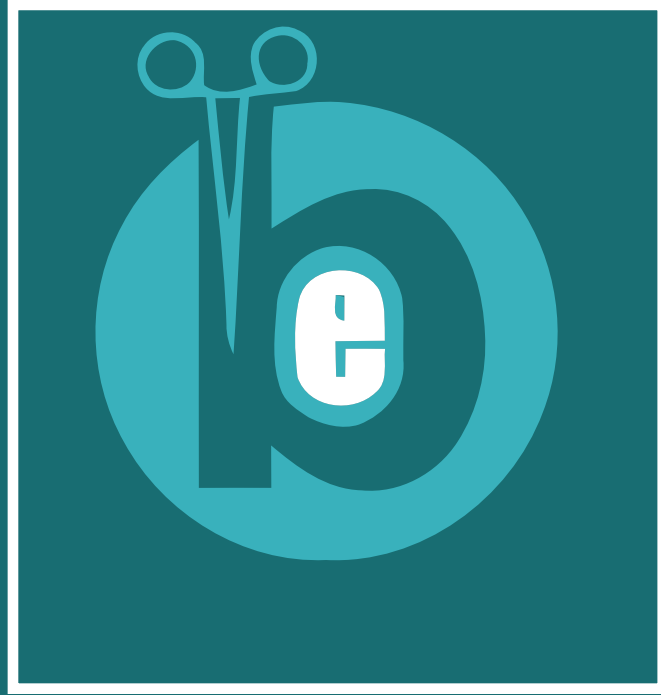

Certified: ISO 9001:2008. CE



BOUNKAN ROAD P/O
GOHADPUR-51310
SIALKOT-PAKISTAN



CE
ISO: 9001:2008
REGISTERED



by phone: (+92) 300 - 6125071, 333 - 8623076

by email: belmeraent@gmail.com, info@belmeraent.com

web: www.belmeraent.com