



Belmera

ENTERPRISES

MANUFACTURERS, IMPORTERS AND EXPORTERS OF
SURGICAL, DENTAL INSTRUMENTS



*Dental
Instruments
Catalogue*

COMPANY PROFILE



Welcome to the world of **BELMERA ENTERPRISES**

The home of Precision **Surgical, Dental, Veterinary instruments** and all kind of scissors.

Where you get the high quality German standard Instruments under one roof. **BELMERA ENTERPRISES** Established in 1984 by Mr. Mian Bashir Who was the Executive Member of SIMA & SCCI, Pakistan. Belmera Enterprises achieved tremendous success by virtue of constant dedicated efforts, devotion to duty and maintenance of quality control. Through enquiring the state of art production facility and maintaining at all stages which made us one of the best exporter of German standard quality surgical instruments at very competitive price in all over the world especially **Europe, USA, & Canada.**

This quality management system was properly implemented and is being successfully executed at all production stages. This is indeed a result of constant professional and vigorous team effort undertaken by Belmera, the most responsible, professional and dedicated staff members this is why our products are recognized in all over the world. We are certified ISO 9001:2008 & CE

Our Services

Belmera enterprises is one of the **MULTINATIONAL** Company of Pakistan which established their offices in the world biggest market of **GERMANY, SAUDI ARABIA, USA, Canada** and UK. Where our highly Professional Associates always welcome you. www.belmeraent.com because we more emphases to providing the best services to our valuable customer and want to built a long term Professional relationships with them.

Your own Designs and Brand

We understand that every customer has their own designs and Brands Name so we made your Products according to your own specification brand and designs. Please be sure that your brand and design is your own property for that we keep it highly confidential and will never miss handling out side the premises of our industrial unit. We aimed at providing the Best to our customer @ of very competitive price according to their needs and demands by following the high quality technique from Manufacturing to Executing. Belmera is name of the high quality.

Thanks & Regards

Belmera
ENTERPRISES
Shahzad Iqbal
CEO

D
E
N
T
A
L

I
N
S
T
R
U
M
E
N
T
S

TABLE OF CONTENTS

DENTAL INSTRUMENTS

01 Tooth Extracting Forceps

01-49

02 Root Elevators

50-72

03 Scalpel Handles, Mirror Handles, Mouth Mirrors
Scalers, Explorer / Probes

73-87

04 Endodontic Condensers, Obturation Instruments
Excavators, Explorer / Probes

88-97

05 Amalgam Pluggers / Condensers, Burnishers

98-100

06 Wax Carvers, Carvers, Chisels

101-103

07 Composite Placement, Plastic Filling Instruments

104-107

08 Curettes, Gracey Curettes, Dental Products

108-116

TABLE OF CONTENTS

DENTAL INSTRUMENTS

09 Wax Porcelain & Cement Instruments
Wax & Modeling Instruments **117-120**

10 Spatulas, Cement Spatulas **121-123**

11 Files, Hoes, Knives, Wax & Plaster Knives,
Crane Kaplan **124-127**

12 Bone Curettes, Bone Files, Bone Chisels,
Bone Mallets **128-132**

13 Crown Removers, Crown Instruments **133-135**

14 Implants & Measuring Instruments **136-140**

15 Amalgam Guns & Carriers, Retainers, Bands,
Strip Holders, Napkin Holders **141-142**

16 Rubber Dam Instruments, Rubber Dam Clamps **143-144**

TABLE OF CONTENTS

DENTAL INSTRUMENTS

17 Syringes, Tweezers, Sterilizing & Lab Instruments **145-152**

18 Endodontic Forceps, Tissue Forceps, Haemostatic Forceps, Towel Clamps **153-155**

19 Retractors, Lip & Cheek Retractors, Hooks, Depressors & Mouth Gags **156-159**

20 Orthodontic Pliers & Cutters, Rongeurs **160-173**

21 Needle Holders, Scissors, Micro Surgery Set **174-180**

22 Impression Trays **181-187**

23 Articulators, Hollow Wares **198-195**

24 Scissors, Dissecting Forceps, Needle Holders, Wire Cutting Pliers With Tungsten Carbide Inserts **196-208**

Section - 01

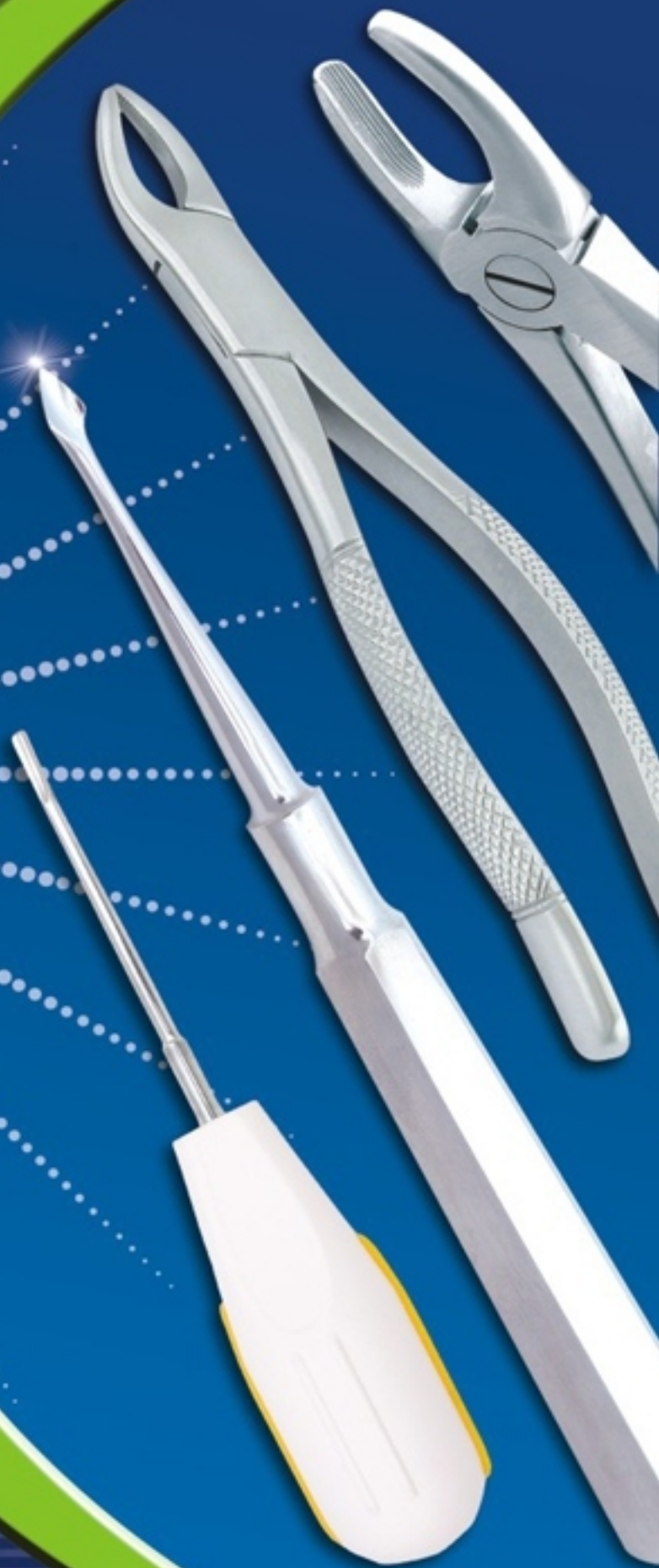

- ★ Extracting Forceps
- ★ Root Elevators

Extracting Forceps "English Pattern" Tungsten Carbide Inserts



1001
Fig. 4
lower incisor



1001
Fig. 4
lower incisor



1002
Fig. 8
lower premolar



1040
Fig. 39L
upper molars left
for children
1002
Fig. 8
lower premolars

Extracting Forceps "English Pattern"



1003
Fig. 1
upper centrals & canines



1004
Fig. 2
upper laterals & canines



1005
Fig. 3
upper incisors & canines



1006
Fig. 4
upper incisors & canines



1007
Fig. 7
upper premolars



1008
Fig. 8
lower premolars



1009
Fig. 13
lower premolars

Extracting Forceps "English Pattern"

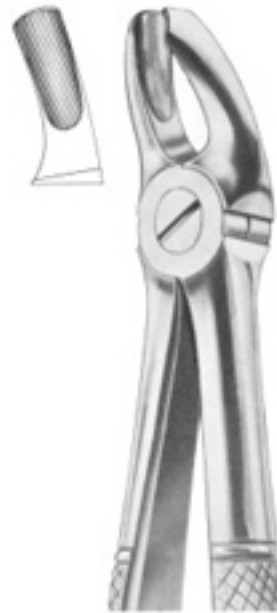

1012
Fig. 18
upper molars, left



1013
Fig. 18A
upper molars



1014
Fig. 18B
upper molars



1015
Fig. 19
upper third molars

Extracting Forceps "English Pattern"



1016
Fig. 20
upper third molars



1017
Fig. 21
lower molars



1018
Fig. 22
lower molars



1019
Fig. 22S
lower molars
for children



1020
Fig. 22G
lower molars



1021
Fig. 23
lower molars right



1022
Fig. 24
lower molars left

Extracting Forceps "English Pattern"



1023
Fig. 29
upper roots



1024
Fig. 29S
upper roots for children



1025
Fig. 30
upper roots



1028
Fig. 30S
upper roots for children



1026
Fig. 31
lower roots



1027
Fig. 32
lower molars

Extracting Forceps "English Pattern"



1029
Fig. 33
lower roots



1030
Fig. 33A
lower roots



1031
Fig. 33B
lower roots



1032
Fig. 33L
lower roots



1033
Fig. 37
upper incisors
for children



1034
Fig. 33S
lower roots
for children

Extracting Forceps "English Pattern"



1035
Fig. 38
lower incisors &
canines for children



1036
Fig. 39
upper molars
for children



1037
Fig. 39R
upper molars right
for children



1040
Fig. 39L
upper molars left
for children



1038
Fig. 39A
upper molars
for children



1039
Fig. 40
lower molars
for children

Extracting Forceps "English Pattern"



1041
Fig. 41
upper roots



1042
Fig. 44
upper roots



1043
Fig. 45
lower roots



1044
Fig. 48
lower roots



1045
Fig. 49
upper roots



1046
Fig. 50
upper roots

Extracting Forceps "English Pattern"



1047
Fig. 51
upper roots



1048
Fig. 51A
upper roots



1049
Fig. 51L
upper roots

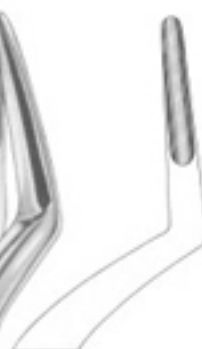

1050
Fig. 52
upper roots



1051
Fig. 52A
upper teeth
and resection



1052
Fig. 51S
upper roots
for children

Extracting Forceps "English Pattern"



1053
Fig. 54
for separating
upper molars



1054
Fig. 55
for separating
upper molars



1055
Fig. 56
for separating
lower molars



1056
Fig. 65R
upper molars
right



1057
Fig. 65L
upper molars left



1058
Fig. 67
upper third molars



1059
Fig. 67A
upper third m

Extracting Forceps "English Pattern"



1060
Fig. 67 1/2 R
upper third molars
right



1061
Fig. 67 1/4 L
upper third molars
left



1062
Fig. 68
lower roots



1063
Fig. 68A
lower roots



1064
Fig. 73
lower molars



1065
Fig. 73R
lower molars right



1066
Fig. 73L
lower molars left

Extracting Forceps "English Pattern"



1067
Fig. 73A
lower molars



1068
Fig. 73S
lower molars



1069
Fig. 73B
lower molars for children



1072
Fig. 73K
lower molars
for children



1070
Fig. 74
lower roots



1071
Fig. 74D
lower roots

Extracting Forceps "English Pattern"



1073
Fig. 74M
lower roots



1074
Fig. 74N
lower roots



1075
Fig. 74XN
lower roots and
crowded incisors



1078
Fig. 76N
upper roots



1076
Fig. 75
lower premolars



1077
Fig. 76
upper roots

Extracting Forceps "English Pattern"



1079
Fig. 76S
upper roots



1080
Fig. 79
lower third molars



1081
Fig. 79A
lower third molars



1082
Fig. 81
lower premolars
and roots

Extracting Forceps "English Pattern"



1083
Fig. 86A
lower molars



1084
Fig. 86B
lower molars



1085
Fig. 86C
lower molars



1086
Fig. 87
lower molars



1087
Fig. 91
for separating
lower molars



1088
Fig. 99
lower molars

Extracting Forceps "English Pattern"



1089
Fig. 101
upper premolars
and roots



1090
Fig. 100
upper roots



1091
Fig. 99 1/4
lower molars



1092
Fig. 99 1/2
lower molars

Extracting Forceps "English Pattern"



1093
Fig. 102
upper molars right



1094
Fig. 103
upper molars left



1095
Fig. 105
lower incisors



1096
Fig. 106
lower incisors



1097
Fig. 103
upper canines

Extracting Forceps "English Pattern"



1098
Fig. 112
upper roots



1099
Fig. 113
upper roots



1101
Fig. 136
upper premolars
and roots



1102
Fig. 137
lower incisors
and roots



1100
Fig. 114
upper roots



1103
Fig. 143
lower roots

Extracting Forceps "English Pattern"



1104
MEAD (MD 1)
upper anteriors,
roots, incisors, canines



1105
MEAD (MD 2)
upper molars



1108
FELSCH (Fig. 210)
upper third molars



1106
MEAD (MD 3)
lower roots



1107
MEAD (MD 4)
lower molars



1109
HERTZ (Fig. 211)
lower incisors



1110
ROUTURIER (Fig. 212)
(22 ½ L)
lower molars
and wisdom left



1111
ROUTURIER (Fig. 213)
(22 ½ R)
lower molars
and wisdom right



1112
ROUTURIER (Fig. 214)
(22 ½ L)
lower molars
and wisdom left



1113
ROUTURIER (Fig. 215)
(33 ½ R)
lower molars
and wisdom right



1114
RESECTION FORCEPS
(216/Witzel)
upper roots

Extracting Forceps "English Pattern"



1115
Fig. 5



1116
Fig. 6



1117
Fig. 9



1118
Fig. 10



1119
Fig. 11



1120
Fig. 12



1121
Fig. 14



1122
Fig. 15

Extracting Forceps "English Pattern"



1123
Fig. 25



1124
Fig. 26



1125
Fig. 27



1126
Fig. 28



1127
Fig. 34



1128
Fig. 35



1129
Fig. 42



1130
Fig. 43

Extracting Forceps "English Pattern"



1131
Fig. 44A



1132
Fig. 46



1133
Fig. 47



1134
Fig. 50A



1135
Fig. 74R



1136
Fig. 74L



1137
Fig. 75R



1138
Fig. 75L

Extracting Forceps "English Pattern"



1139
Fig. 94



1140
Fig. 95



1141
Fig. 98



1142
Fig. 105



1143
Fig. 106



1144
Fig. 2002

Extracting Forceps "With Fitting Handle"



1145
Fig. 1
upper laterals
and canines



1146
Fig. 2
upper laterals
and canines



1147
Fig. 3
upper incisors
and canines



1148
Fig. 4
lower incisors
and canines



1149
Fig. 7
upper premolars



1150
Fig. 13
lower premolars



1151
Fig. 13S
lower premolars
for children.



1152
Fig. 17
upper molars right



1153
Fig. 18
upper molars left



1154
Fig. 18A
upper molars



1155
Fig. 18B
upper molars



1156
Fig. 19
upper third molars



1157
Fig. 22
lower molars



1158
Fig. 22S
lower molars
for child



1159
Fig. 29
upper roots



1160
Fig. 29S
upper roots
for children



1161
Fig. 30
upper roots



1162
Fig. 30S
upper roots
for children



1163
Fig. 33
lower roots



1164
Fig. 33A
lower roots



1165
Fig. 33B
lower roots



1166
Fig. 33L
lower roots



1167
Fig. 33S
lower roots
for children



1168
Fig. 37
upper incisors
for children



1169
Fig. 39
upper incisors
for children



1170
Fig. 39A
upper molars
for children



1171
Fig. 39R
upper molars right
for children



1172
Fig. 39L
upper molars left
for children



1173
Fig. 41
upper roots



1174
Fig. 44
upper roots



1175
Fig. 45
lower roots



1176
Fig. 48
lower roots

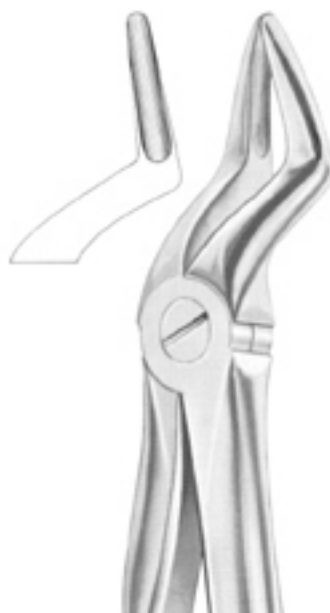

1177
Fig. 51
upper roots



1178
Fig. 51A
upper roots



1179
Fig. 51S
upper roots
for children



1180
Fig. 51L
upper roots

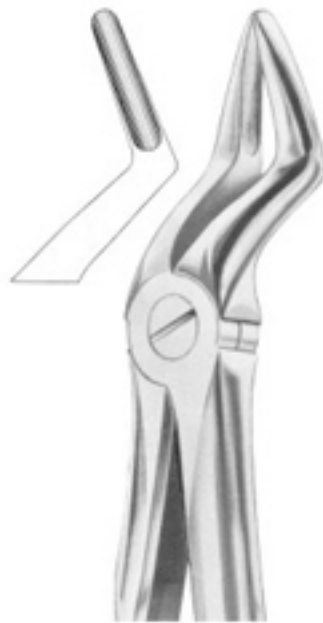

1181
Fig. 52
upper roots



1182
Fig. 54
for separating
upper molars



1183
Fig. 65R
upper molars right



1184
Fig. 65L
upper molars left



1185
Fig. 67
upper third molars

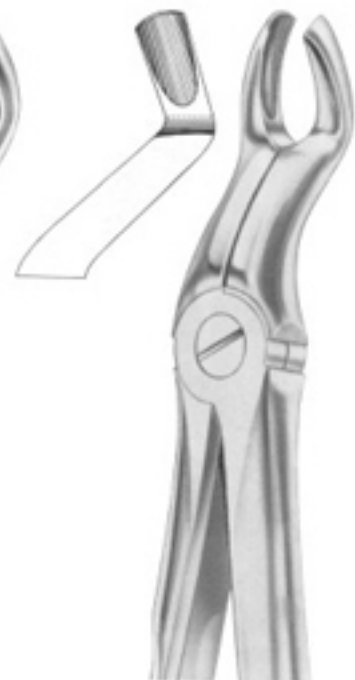

1186
Fig. 67A
upper third molar



1187
Fig. 67 1/2 R
upper third molars
right

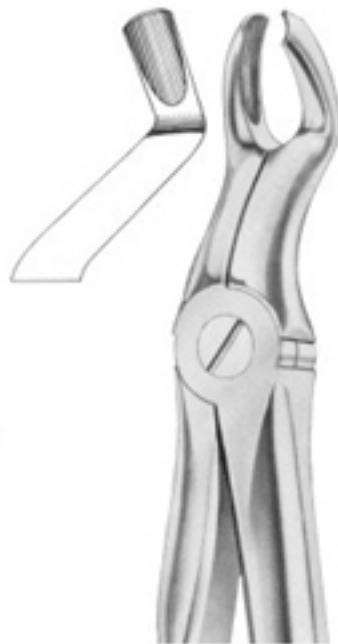

1188
Fig. 67 1/2 L
upper third molars
left



1189
Fig. 73
lower molars



1190
Fig. 74
lower roots



1191
Fig. 74M
lower roots



1192
Fig. 74N
lower roots



1193
Fig. 74XN
lower roots and
crowded incisors



1194
Fig. 75
lower premolars



1195
Fig. 76
upper roots



1196
Fig. 76N
upper roots



1197
Fig. 81
lower premolars
and roots



1198
Fig. 76A
lower third molars



1199
Fig. 79
lower third molars



1200
Fig. 86A
lower molars



1201
Fig. 86B
lower molars



1202
Fig. 86C
lower molars



1203
Fig. 99
lower molars



1204
Fig. 99 1/4
lower molars



1205
Fig. 136
upper premolars
and roots



1206
Fig. 143
lower roots

Extracting Forceps "For Children"



1207
KLEIN (Fig. 217)
upper incisors



1208
KLEIN (Fig. 218)
upper premolars



1209
KLEIN (Fig. 219)
upper roots



1210
KLEIN (Fig. 220)
upper molars



1211
KLEIN (Fig. 221)
lower incisors



1212
KLEIN (Fig. 222)
lower molars



1213
KLEIN (Fig. 223)
lower roots



1214
ALBRECHT
Fig. 224
Deciduous



1215
ALBRECHT
Fig. 225
Deciduous

Root Splinter Forceps

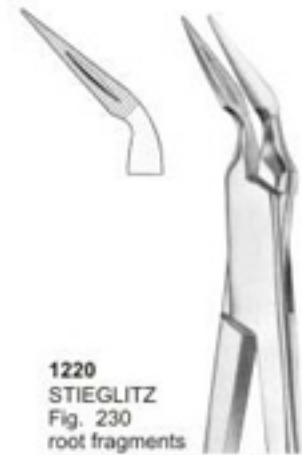
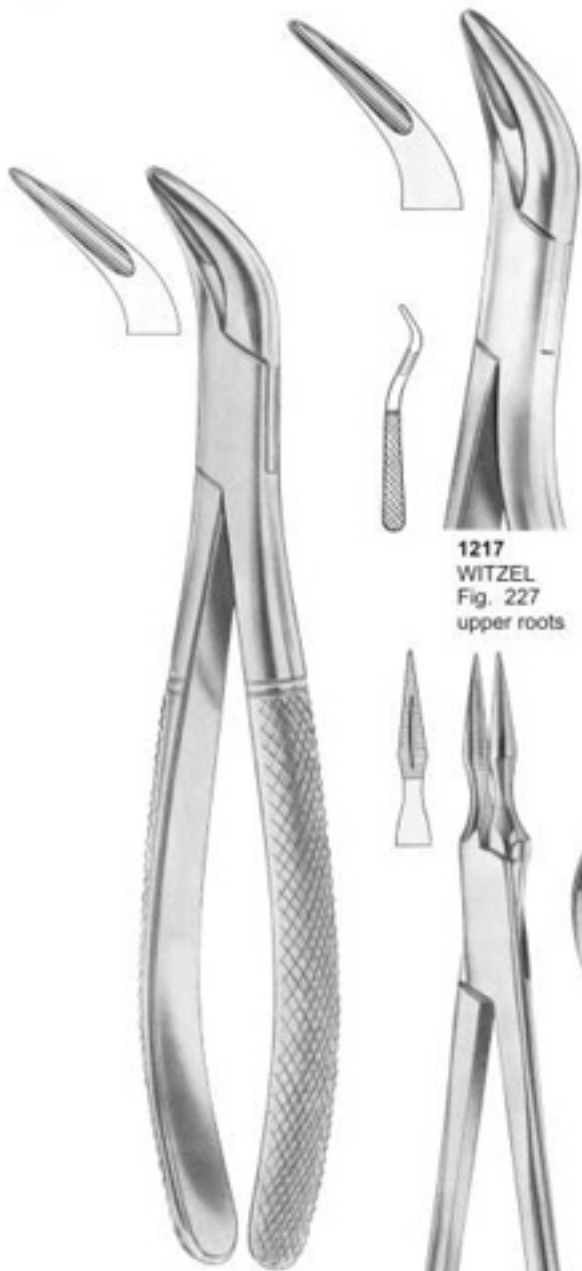

Extracting Forceps "American Pattern"



1222
W1-WINTER
upper centrals
and canines



1223
Fig. 1
upper incisors and roots



1224
Fig. 2
upper and lower roots



1225
Fig. 4
upper and lower premolars



1226
PHYSICK
Fig. 5
lower third molars



1227
Fig. 6
separating
forceps



1228
Fig. 7
upper roots

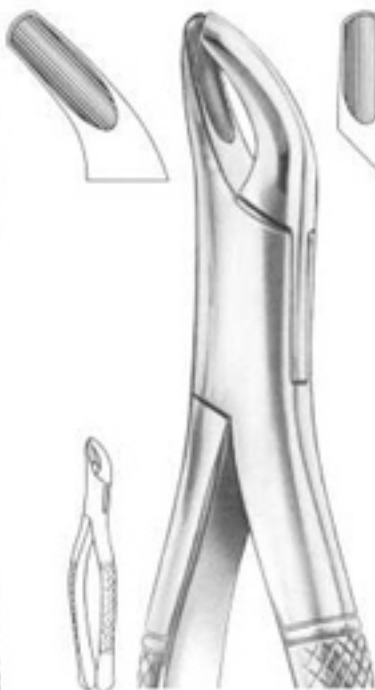

1229
Fig. 8
upper and lower
third molars



1231
Fig. 10H
upper molars



1232
Fig. 13
upper incisors



1230
Fig. 10S
upper molars



1233
Fig. 14
lower incisor



1234
Fig. 16
lower molars



1235
HARRIS
Fig. 15
lower molars



1237
HARRIS
Fig. 18R
upper molars right



1238
HARRIS
Fig. 18L
upper molars left



1236
Fig. 16S
lower molars
for children



1239
Fig. 17
lower molars

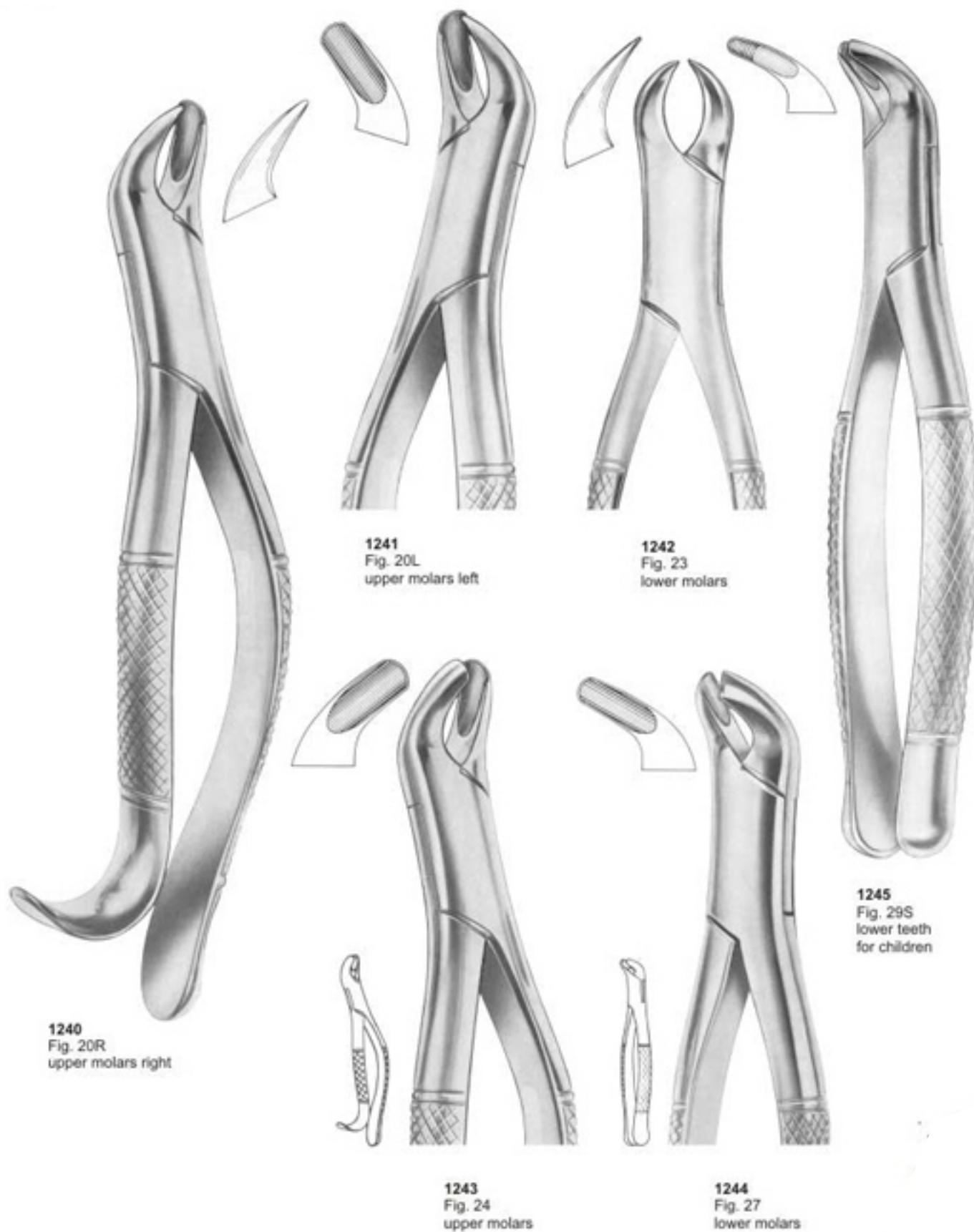

Extracting Forceps "American Pattern"



1246
Fig. 30S
upper teeth
for children



1247
PARMLY
Fig. 32
upper premolars
and molars



1248
PARMLY
Fig. 32A
upper premolars
and roots



1249
Fig. 34
lower anteriors
and roots



1250
Fig. 35
upper roots



1251
Fig. 36
lower anterior
and roots



1252
Fig. 37
lower anteriors
and roots

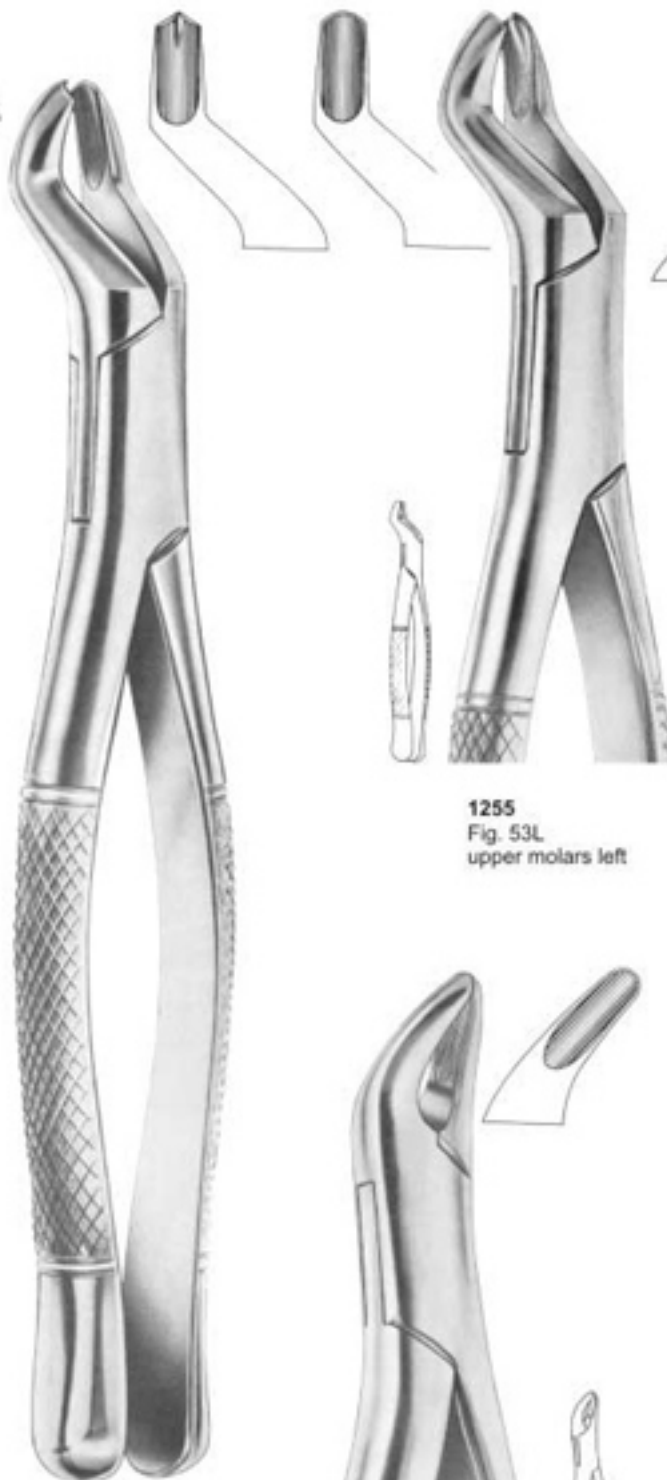

1254
Fig. 53R
upper molars right



1255
Fig. 53L
upper molars left



1253
Fig. 38
upper anteriors
and roots



1256
Fig. 62
incisors, premolars,
deciduous teeth

1257
Fig. 65
upper incisors
and roots

Extracting Forceps "American Pattern"



1258
TOMEs
Fig. 69
upper and lower roots



1259
TOMEs
Fig. 85
lower canines,
premolars and molars



1260
NEVIUS
Fig. 88R
upper molars right



1261
THOMAS
Fig. 85A
lower canines,



1262
NEVIUS
Fig. 88L
upper molars left

Extracting Forceps "American Pattern"



1263
KELLS
Fig. 99A
upper incisors,
canines, premolars



1264
Fig. 104
upper third molars



1266
HULL
Fig. 101
deciduous teeth



1267
Fig. 103
lower incisors,
premolars



1265
KELLS
Fig. 99C
upper incisors,
canines, premolars

Extracting Forceps "American Pattern"



1268
CRYER
Fig. 150
lower incisors,
premolars, roots



1269
CRYER
Fig. 150A
upper incisors,
premolars, roots



1271
CRYER
Fig. 151
lower incisors,
premolars, roots



1272
CRYER
Fig. 151A
lower incisors,
premolars, roots



1270
CRYER
Fig. 150S
upper teeth for children



1273
CRYER
Fig. 151S
lower teeth
for children



1274
Fig. 203
lower incisors
and roots



1275
Fig. 210S
upper third molars



1277
Fig. 210H
upper third molars



1278
Fig. 213
upper centrals and canines



1276
Fig. 201
upper incisors,
canines, premolars

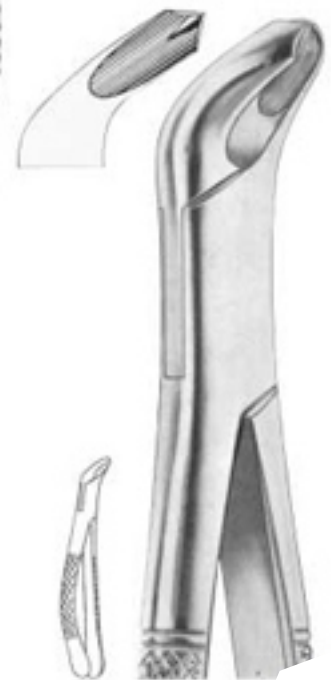

1279
Fig. 217
lower molar

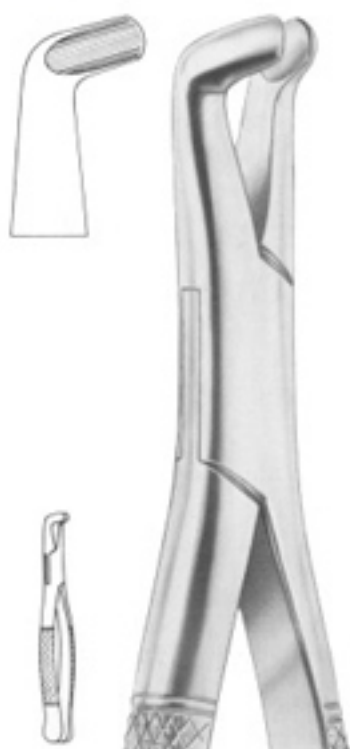

1280
Fig. 222
lower third molars



1282
Fig. 286
Swing lower molars



1283
Fig. 288
lower canines
and premolars



1281
Fig. 286
upper incisors and roots

Extracting Forceps "American Pattern"



1284
COHEN
Fig. 310
universal forceps

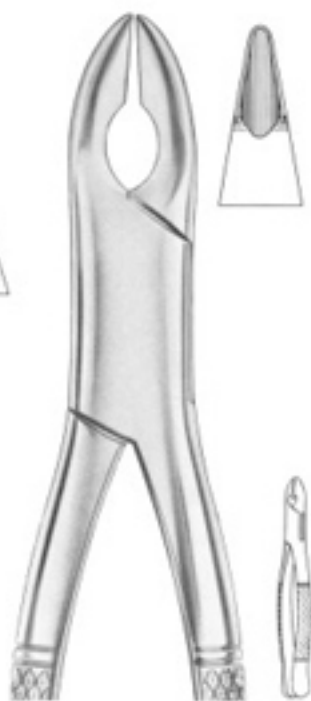

1285
NEVIUS
Fig. 320/10S
upper canines



1287
NEVIUS
Fig. 325/10H
upper canines



1288
STANDARD
Fig. 330/4
upper third molars



1286
HENAHAN
Fig. 315/1A
upper incisors

Extracting Forceps "American Pattern"



1289
WOODWARD
Fig. 335/FH
lower molars



1290
Fig. 340/89
upper molars right



1292
Fig. 345/90
upper molars left

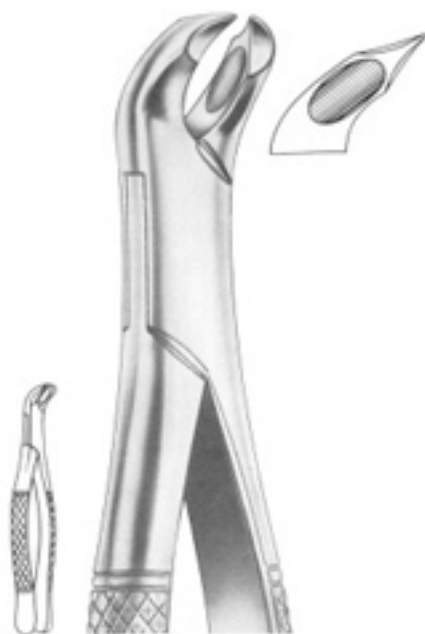

1291
WOODWARD
Fig. 335/FS
lower molars



1293
Fig. 350/23S
lower molars



1295
Fig. 360/17SK
lower molars



1296
Fig. 365/150SK
upper anteriors
and roots



1297
Fig. 370/151SK
lower anteriors
and roots



1294
Fig. 355/23SK
lower molars

Root Tip



1298
DEL 78



1299
DEL 79



1300
DEL 80

Heidbrink Root - Tip Picks



1301
DEL H1



1302
DEL H2



1303
DEL H3



1304
DEL H2-3

POTTS



PERIOSTEAL



Root Elevators

lower jaw, left side

lower jaw, right side



1312



1313

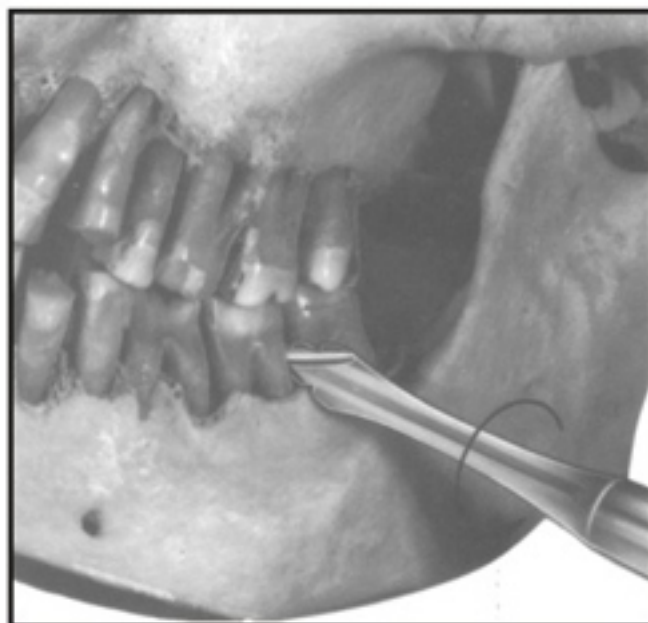

Root elevator, spiral-shaped, for extremely facilitated extraction of the molars in the lower jaw. The slender, conical points allow deep penetration between tooth and gum. Owing to the hook-shaped working parts, slipping of the elevator is avoided.

Root Elevators



1314
BEIN



1315
BEIN
Fig. 1



1316
BEIN
Fig. 2



1317
BEIN
Fig. 0



1318
BEIN
Fig. 3



1319
BEIN
Fig. 4



1320
BEIN
Fig. 5



1321
BEIN
Fig. 6

Root Elevators



1322
SELDIN



1323
SELDIN
Fig. 1L



1324
SELDIN
Fig. 1R



1325
SELDIN
Fig. 2



1326
SELDIN
Fig. 3



1327
SELDIN
Fig. 4L



1328
SELDIN
Fig. 4R

Root Elevators



1329
CRYER
Fig. 3



1330
CRYER
Fig. 4



1331
CRYER
Fig. 12



1332
CRYER
Fig. 27



1333
CRYER
Fig. 28



1334
CRYER
Fig. 27S



1335
CRYER
Fig. 28S

Root Elevators



1336
IS-APICAL



1337
APICAL
Fig. 1



1338
APICAL
Fig. 2



1339
APICAL
Fig. 3



1340
APICAL
Fig. 4

Root Elevators



1341
IS-CRYER



1342
CRYER
Fig. 1



1343
CRYER
Fig. 2



1344
IS-COUPLAND



1345
COUPLAND
Fig. 1



1346
COUPLAND
Fig. 2



1347
COUPLAND
Fig. 3

Root Elevators



1348
Fig. 1



1349
Fig. 2



1350
Fig. 3



1351
FLOHR
Fig. 1



1352
FLOHR
Fig. 2



1353
FLOHR
Fig. 3

Root Elevators



1354
KOPP
Fig. 1



1355
KOPP
Fig. 2



1360
KOPP
Fig. 1



1361
KOPP
Fig. 2



1354
KOPP



1356
KOPP
Fig. 3



1357
KOPP
Fig. 4



1360
KOPP



1362
KOPP
Fig. 3



1363
KOPP
Fig. 4



1358
KOPP
Fig. 5



1359
KOPP
Fig. 6

Root Elevators



1364
HYLIN



1364
HYLIN
Fig. 1



1365
HYLIN
Fig. 2



1366
BEIN



1366
BEIN
Fig. 1



1367
BEIN
Fig. 2



1368
BEIN
Fig. 3



1369
BEIN
Fig. 4

Root Elevators



1370
WARWICK-JAMES
Fig. 1



1371
Warwick-James
Fig. 2



1372
Warwick-James
Fig. 3



1373
London-Hospital
Fig. 1



1374
London-Hospital
Fig. 2



1375
London-Hospital
Fig. 3



1376
OTT

Root Elevators



1377
Fig. 1



1378
Fig. 2



1379
Fig. 1



1380
Fig. 2

Root Elevators



1381
CHOMPRET
Fig. 1



1382
CHOMPRET
Fig. 2



1383
CHOMPRET
Fig. 3



1384
CHOMPRET
Fig. 4



1385
APICAL

Root Tip Elevators



1386
IS-Fig. 1



1387
Fig. 2



1388
Fig. 3



1389
HEIDBRINK
Fig. 1



1390
HEIDBRINK
Fig. 1



1391
HEIDBRINK
Fig. 2



1392
HEIDBRINK
Fig. 3

Root Elevators



1394
MEAD
MD-5 A

1395
MEAD
MD-6 A

1396
MEAD
MD-7 A

1397
MEAD
MD-8



1393
MEAD
MD1

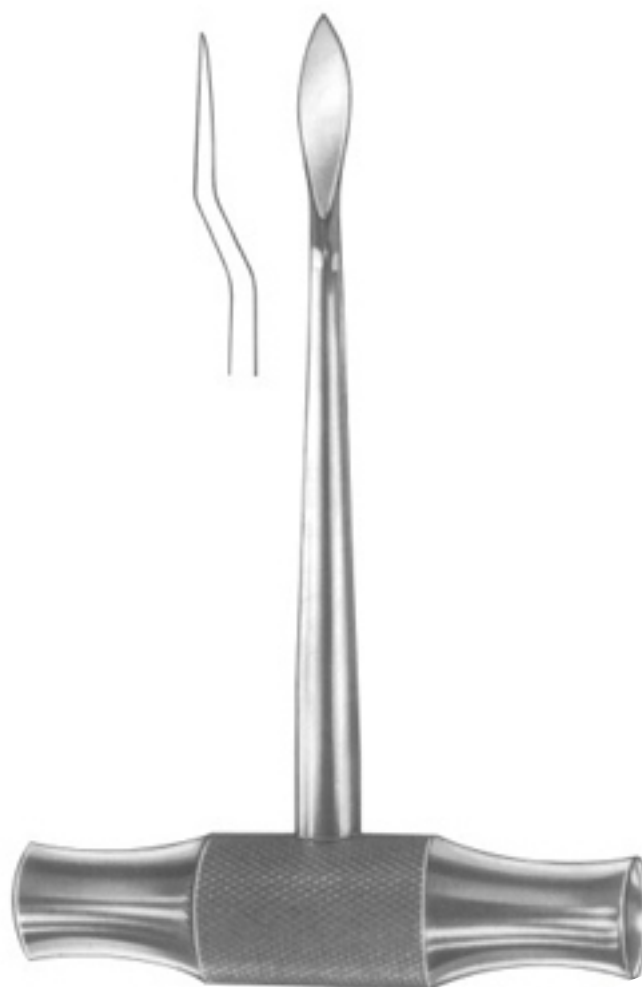

1398
LECLUSE

Root Elevators



1399
WINTER
Fig. 1L



1400
WINTER
Fig. 1R



1401
WINTER
Fig. 2L



1402
WINTER
Fig. 2R



1403
WINTER
Fig. 11L



1404
WINTER
Fig. 11R



1405
WINTER
Fig. 12L



1406
WINTER
Fig. 12R

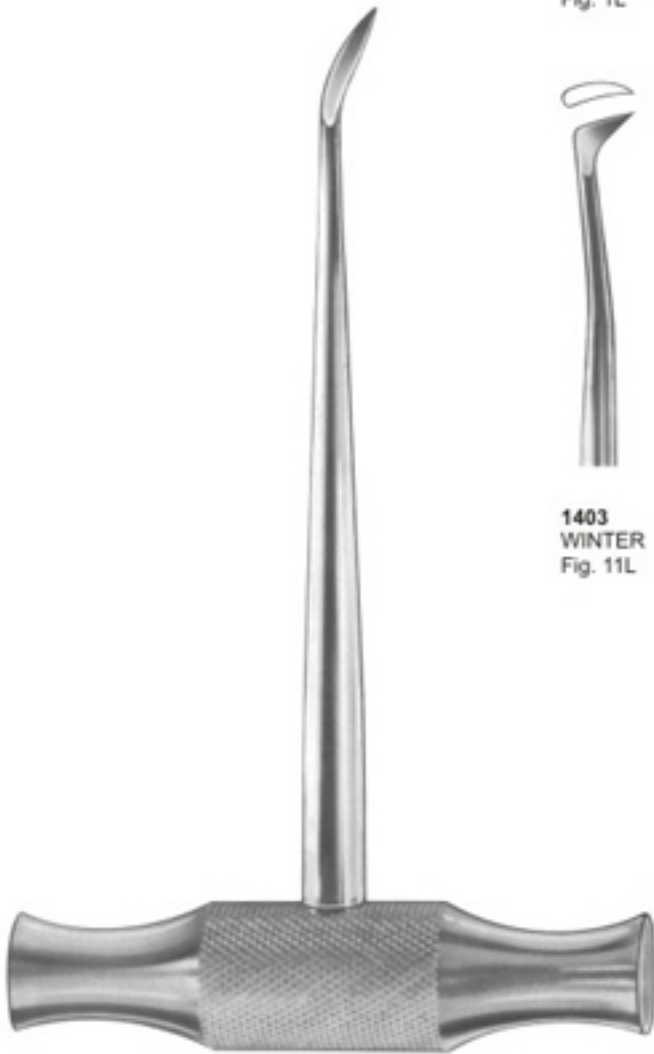

1399
WINTER



1407
WINTER
Fig. 14L



1408
WINTER
Fig. 14R

Root Elevators



1409
BARRY
Fig. 1



1410
BARRY
Fig. 2



1411
BARRY
Fig. 3



1412
BARRY
Fig. 4



1409
BARRY



1413
BARRY
Fig. 11



1414
BARRY
Fig. 12



1415
BARRY
Fig. 17



1416
BARRY
Fig. 18

Root Elevators



1418
CRYER
Fig. 26



1419
SELDIN
Fig. 27



1420
CRYER
Fig. 28



1421
CRYER
Fig. 29



1422
HEIDBRINK
Fig. 22



1423
HEIDBRINK
Fig. 23



1417

Root Elevators



1425
KOPP
Fig. 31



1426
KOPP
Fig. 32



1427
KOPP
Fig. 33



1428
KOPP
Fig. 34



1429
KOPP
Fig. 35



1430
KOPP
Fig. 44

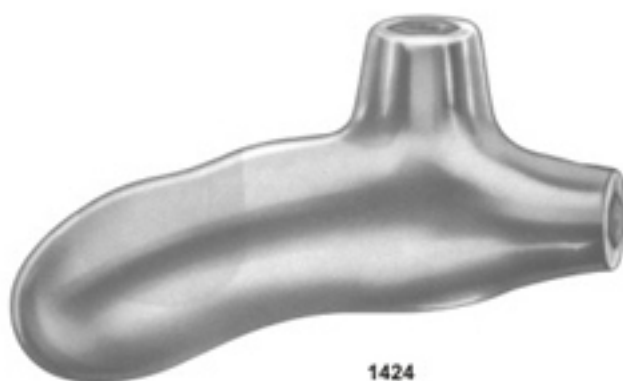

1424

Root Elevators



1432
HEIDBRINK
Fig. 10



1433
WINTER
Fig. 11



1434
WINTER
Fig. 12



1435
BARRY
Fig. 17



1436
BARRY
Fig. 18



1437
BARRY
Fig. 20

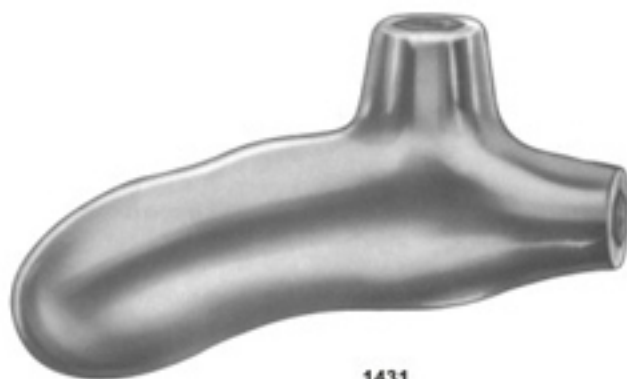

1431

Root Elevators according to Dr. Sader,
with interchangeable working tips



1439



1438



1440

1441
Root Elevator, Plastic Handle, Set of 10 Pcs

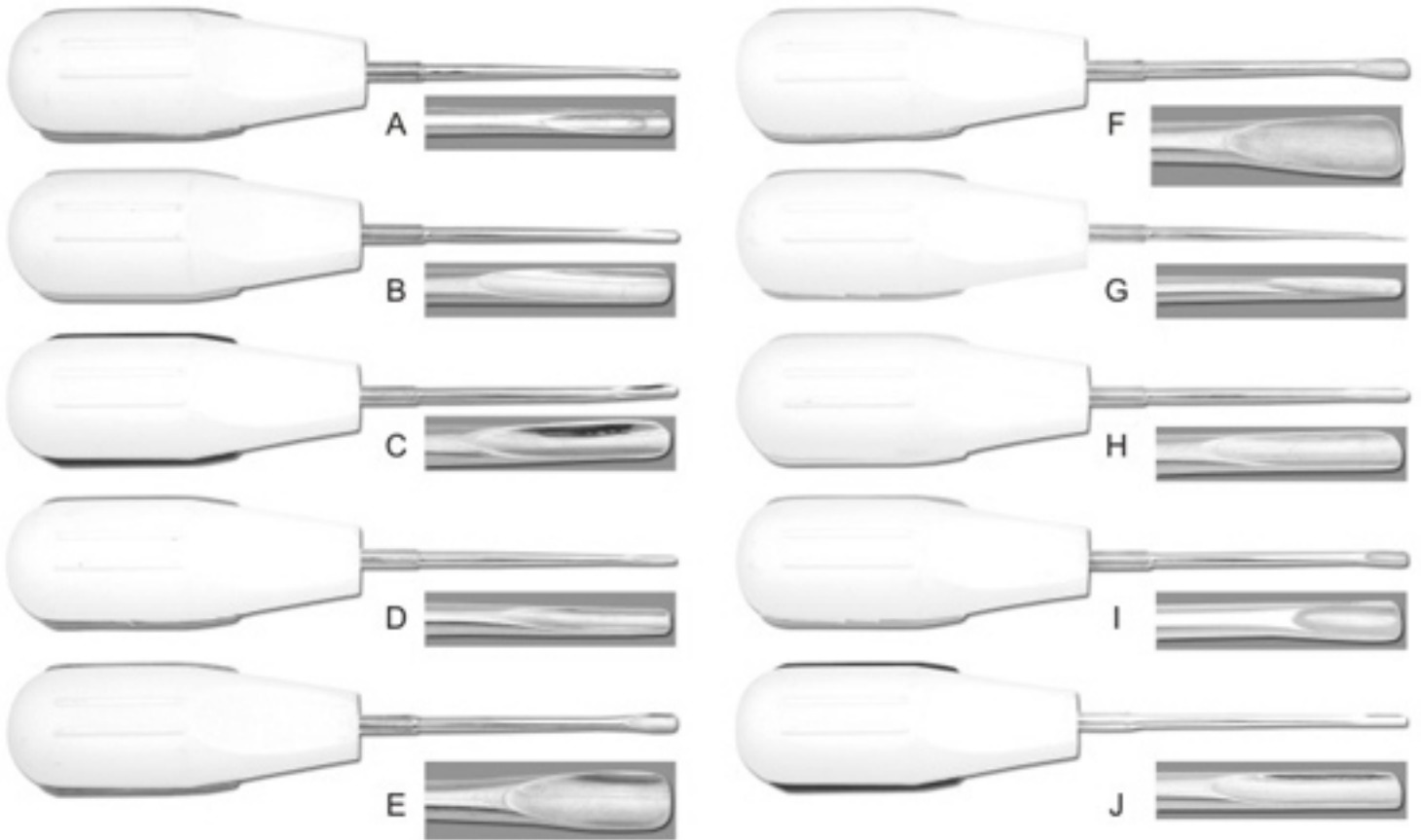

1442
Root Elevator, Plastic Handle, Set of 5 Pcs

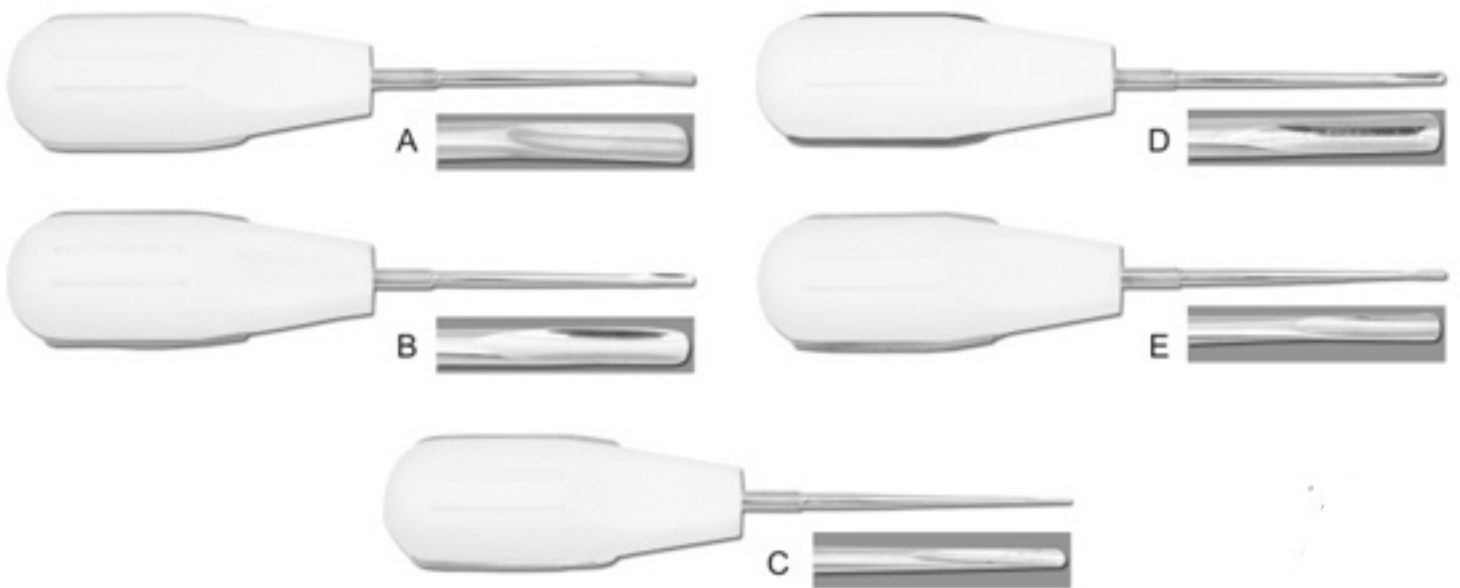

Section - 02



- ★ Scalpel Handles
- ★ Mouth Mirrors, Handles
- ★ Scalers
- ★ Explorers
- ★ Probes
- ★ Condensers
- ★ Excavators



Scalpel Handles



1443
Fig. 3L



1444
Fig. 7



1445
Fig. 5



1446
Fig. 5A



1447
Fig. 3



1448
Fig. 3G



1449
Fig. 4

Handle For Mouth Mirrors, Probes, Explorers, Excavators, Carvers, Curettes & Scalars



1450
Handle No. 2 (Standard Double Ended)



1451
Handle No. 2 Standard Single Ended



1452
Handle No. 2 Thompson Single Ended



1453
Handle No. 4



1454
Octagonal Double Ended



1455
Octagonal Single Ended



1456
Handle, Double Ended



1457
Double Ended



1458
Handle No. 6 Double Ended



1459
Tactile Tone Double Ended



1460
Tactile Tone Single Ended

Handles & Mouth Mirrors

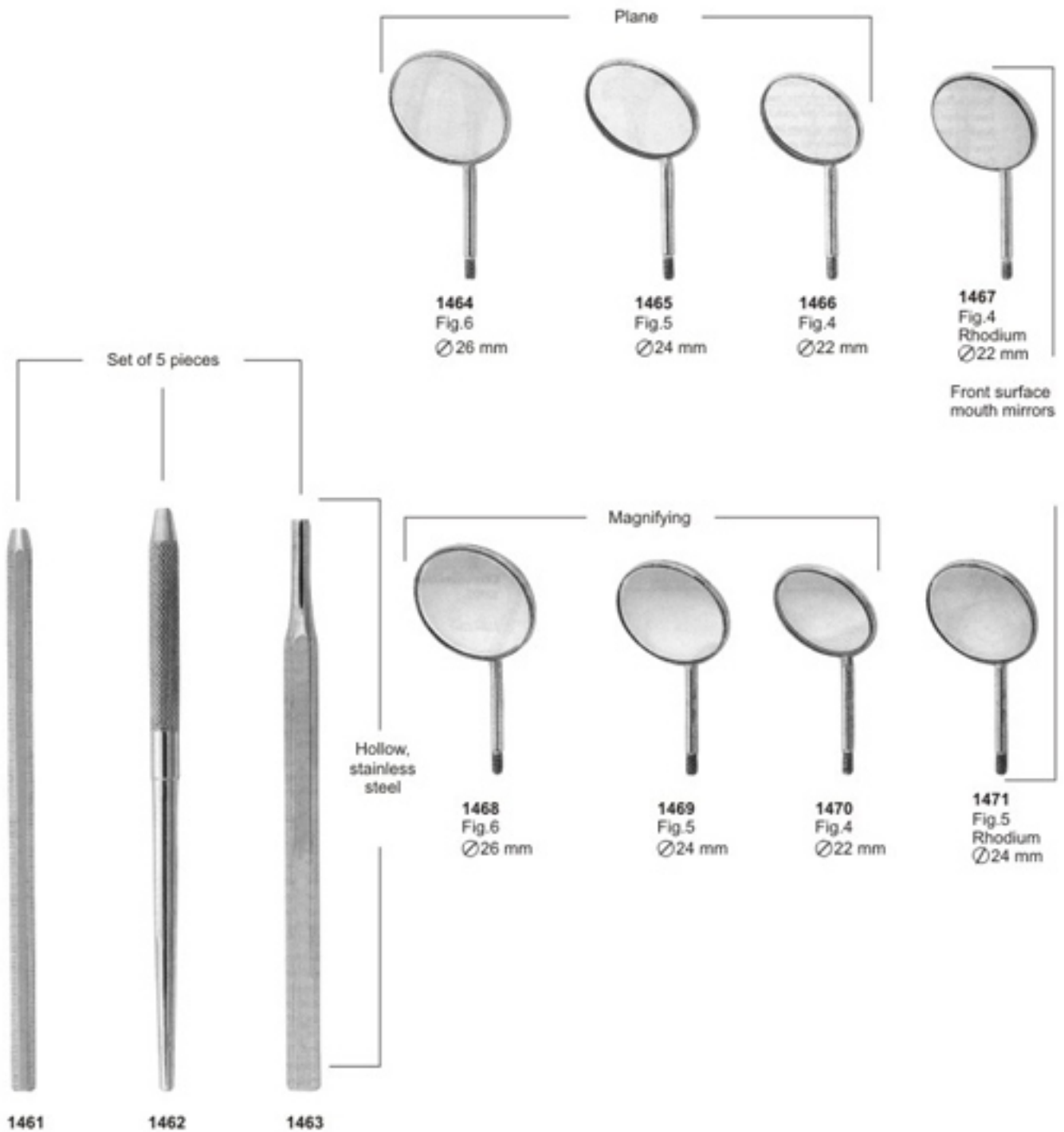

Mirror Handle, Mouth Mirrors



1472



1473



1474



1475



1476



1477
Parallelometer
mouth mirror

1478
Parallelometer
mouth mirror
+ handle
code 2101

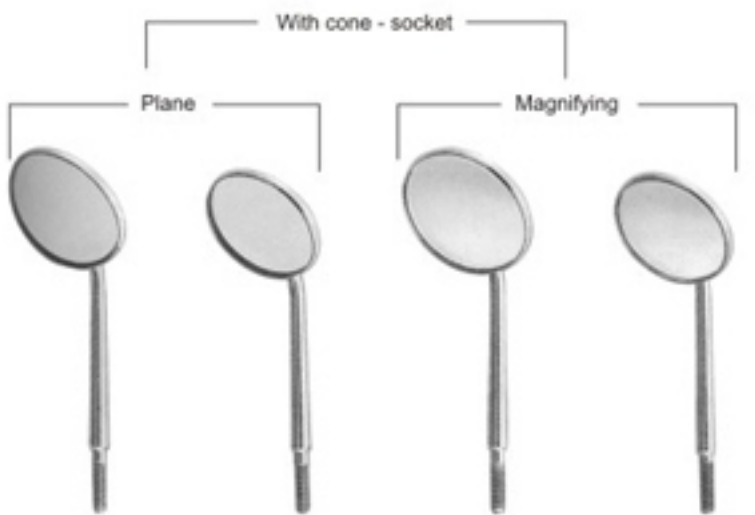

1479
Fig.5
Ø24 mm

1480
Fig.4
Ø22 mm

1481
Fig.5
Ø24 mm

1482
Fig.4
Ø22 mm



1483
Cone-socket



1484
Cone-socket



1485
Cone-sr

SCALERS - JAQUETTE

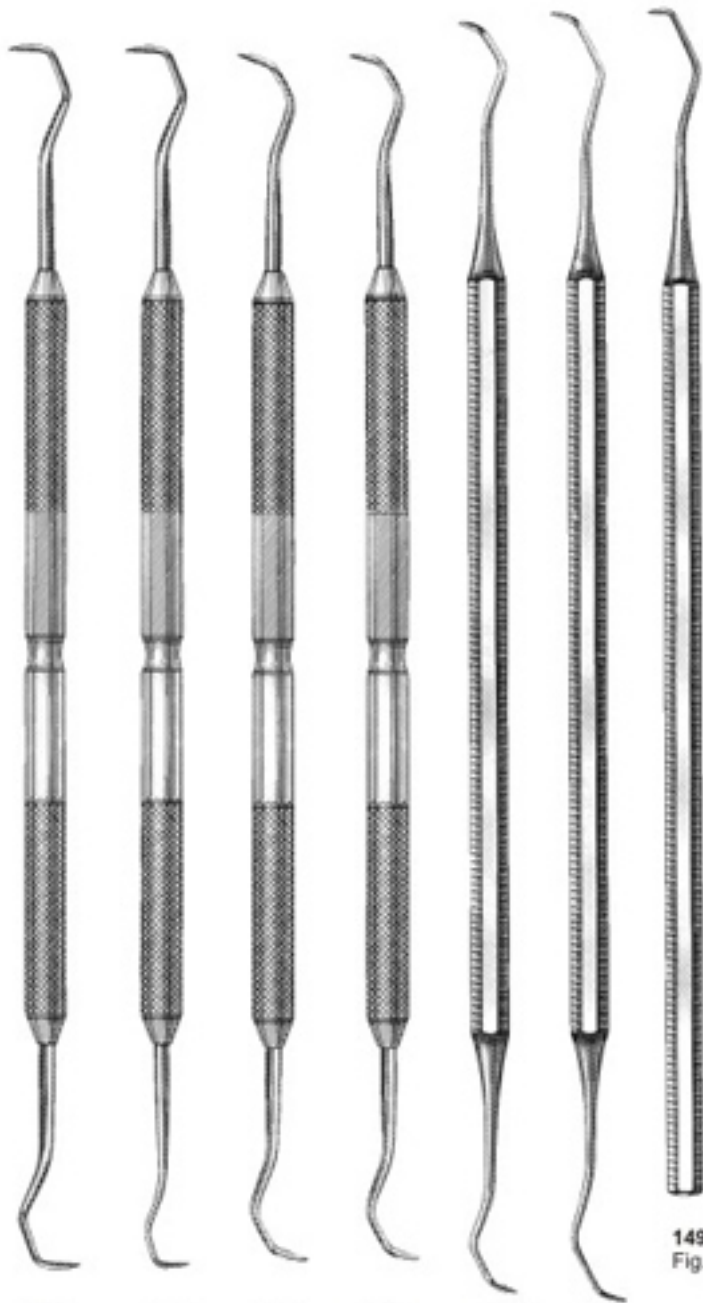

1486 1Y-1Y
1487 1Y-1YS
1488 2Y-3Y
1489 2YS-3YS
1490 2-3
1491 2S-3S

1492
Fig.1

SCALERS - OCTAGONAL

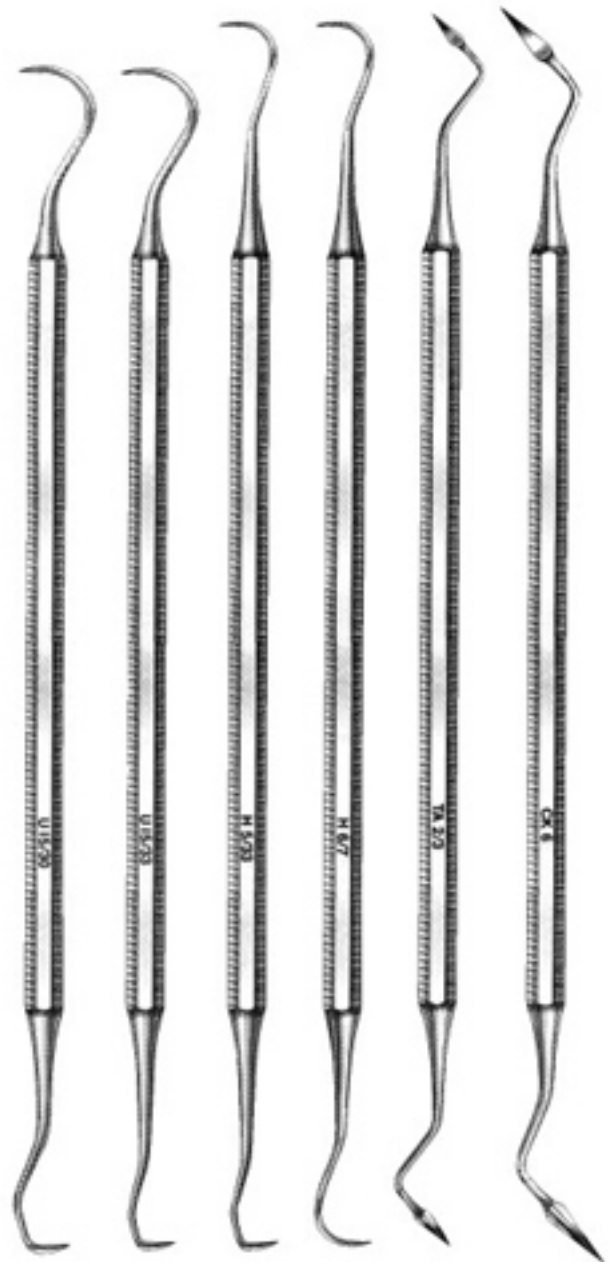

1493 U15-30
1494 U15-33
1495 H5-33
1496 H6-7
1497 Taylor 2-3
1498 CK6

Scalers



1499
U15



1500
No. 3



1501
No. 12



1502
WHITESIDE 1-0



1503
WHITESIDE 2-0

Scalers



1504
YAOUNGER/GOOD
7-8



1505
H5-33



1506
204SD



1507
H6-7



1508
204S



1509
TOWNER/JAQUETTE
U15-30

Scalers



1510
JAQUETTE (33-U15)



1511
JAQUETTE
2Y-3Y



1512
JAQUETTE
30-U15



1513
JAQUETTE
2YS-3YS



1514
JAQUETTE
33-H5



1515
YOUNGER/GOOD
7-8



1516
204S



1517
204SD



1518
H6-7

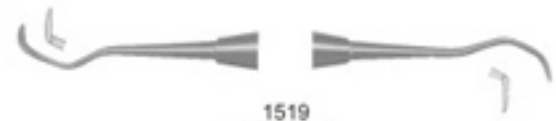

1519
JAQUETTE
2S-3S



1520
JAQUETTE
1Y-1YS



1521
JAQUETTE
2-3

Scalers



1522
JAQUETTE (33-U15)



1523
S204

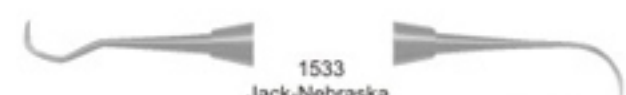

1533
Jack-Nebraska



1524
S204S



1534
Jaquette 1-U15



1525
S204SD



1535
Jaquette 2-3



1526
Goldman 6-7



1536
Jaquette 2S-3S



1527
Goldman Fox 21



1537
Jaquette 30-U15



1528
H5-U15



1538
Jaquette 30-33

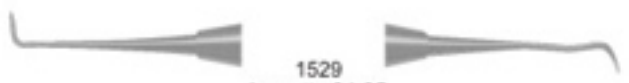

1529
Jaquette 34-35

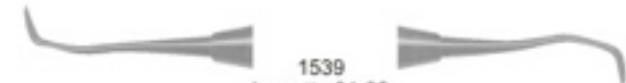

1539
Jaquette 31-32



1530
Thompson Jr.



1540
Jaquette 33-H5



1531
UT107-108



1541
U 6-7



1532
UP128



1542
128L

Explorers Double Ended - Octagonal

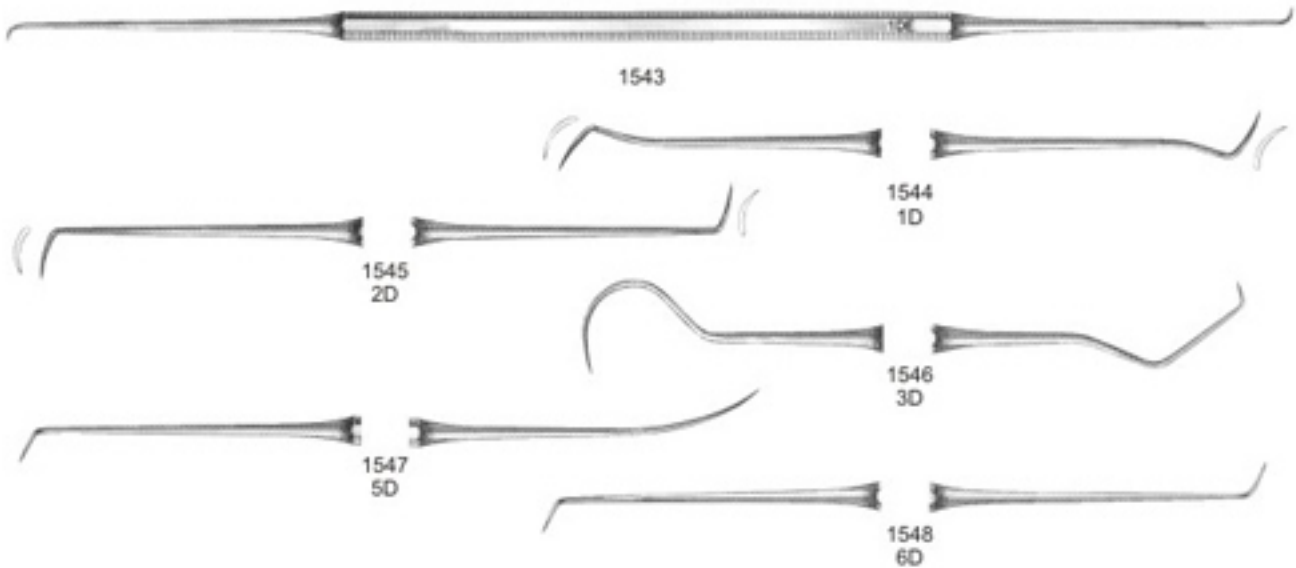

Explorers Double Ended - Standard

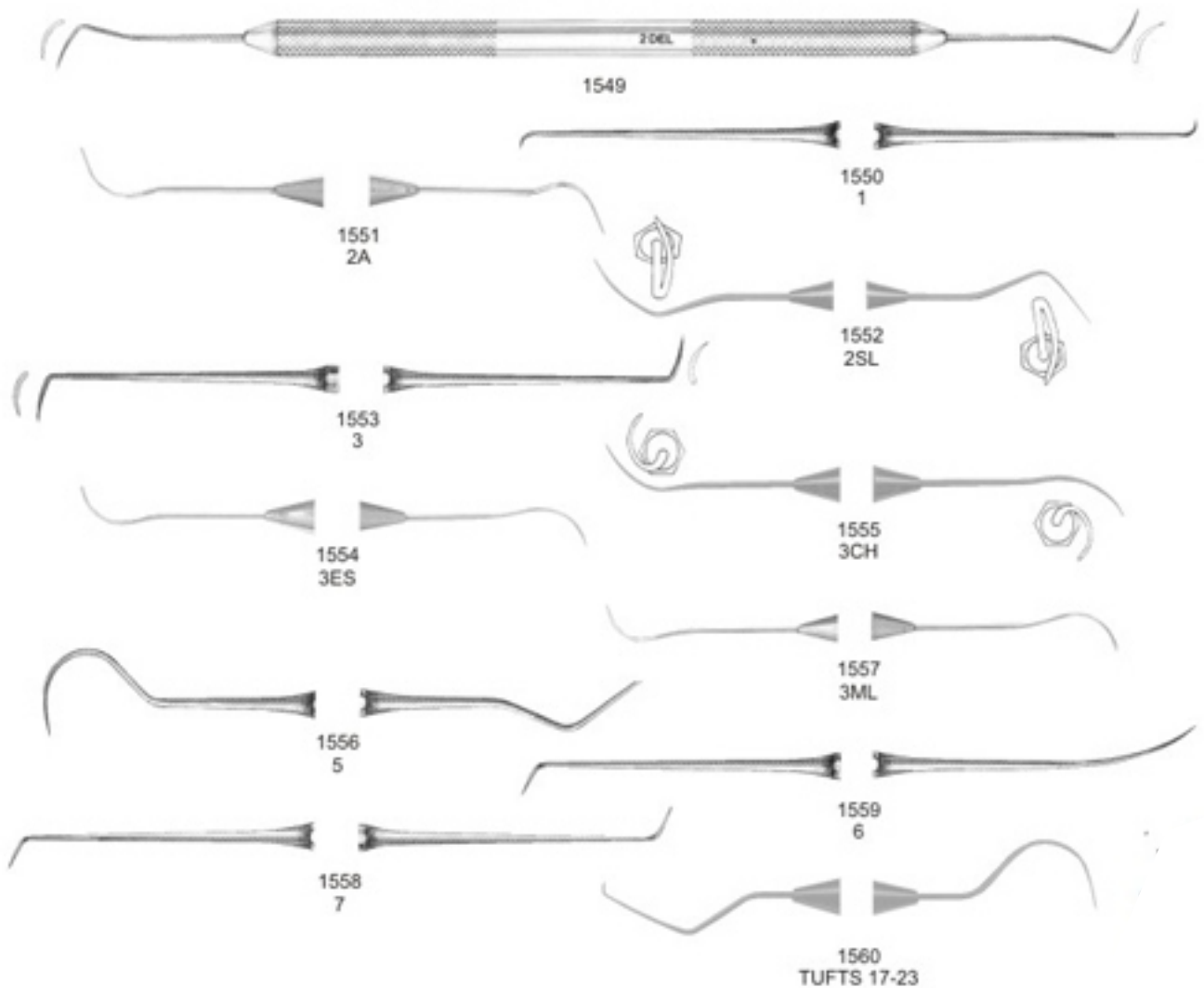

Explorers Double Ended Tactile Tone



1561
2A



1562
2

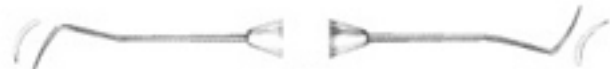

1568
1



1563
2SL



1569
3



1564
3CH



1570
3ES



1565
3ML



1571
5



1566
6



1572
7

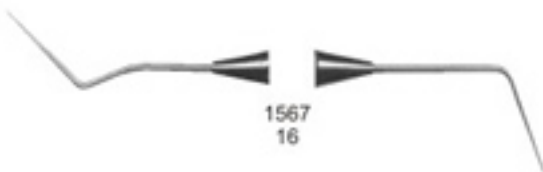

1567
16



1573
TUFTS 17/23

Explorers Single Ended - Octagonal

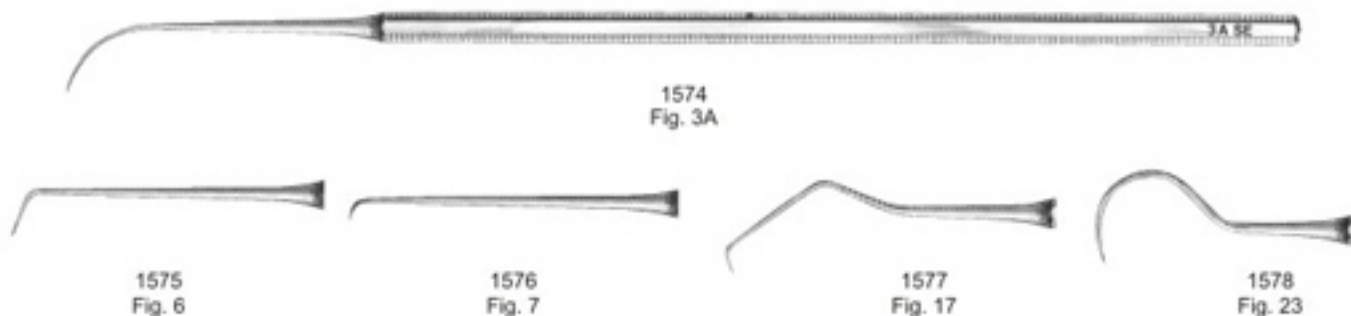

Explorers Single Ended - Standard

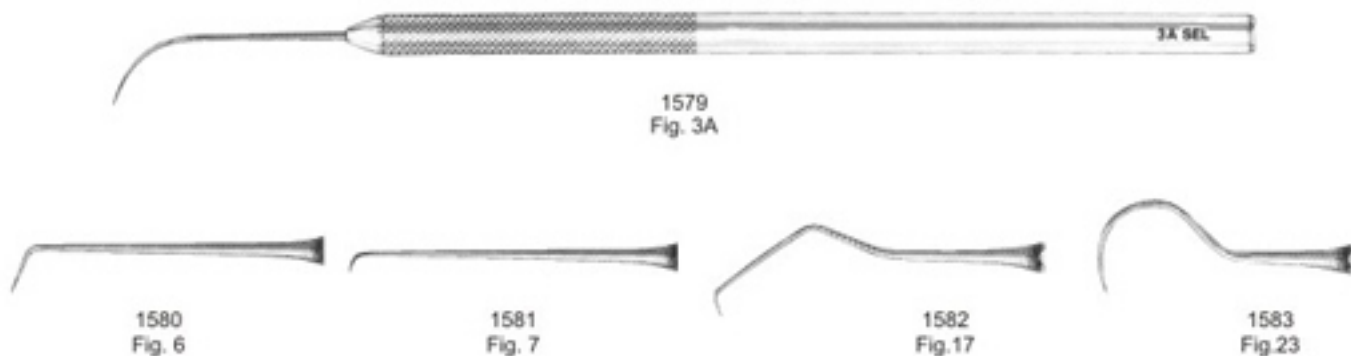

Probe / Explorer - Octagonal



Double Ended Probe - Octagonal



Probes Double Ended - Standard

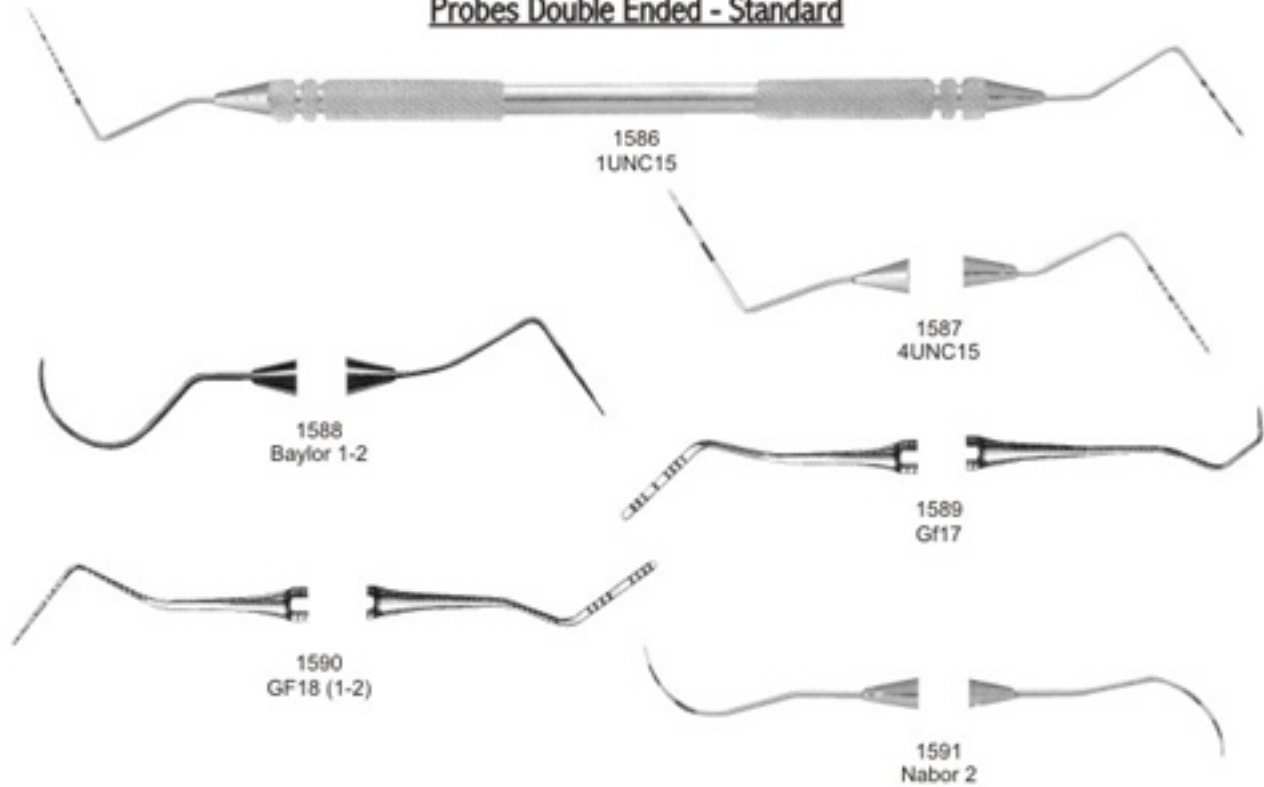

Probes Double Ended - Tactile Tone

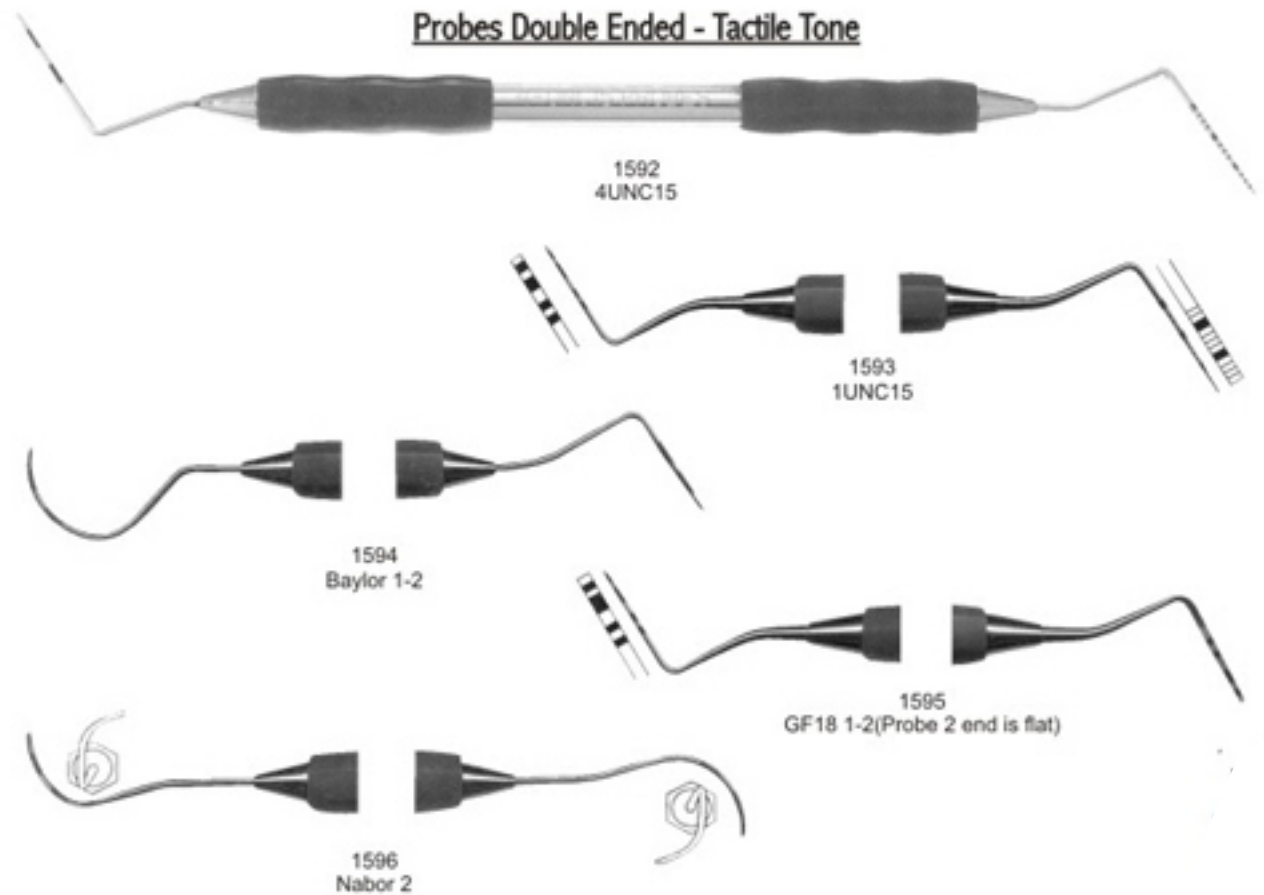

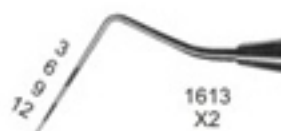
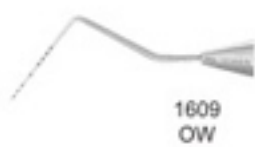
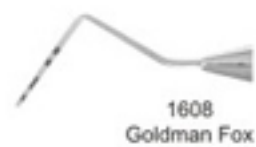
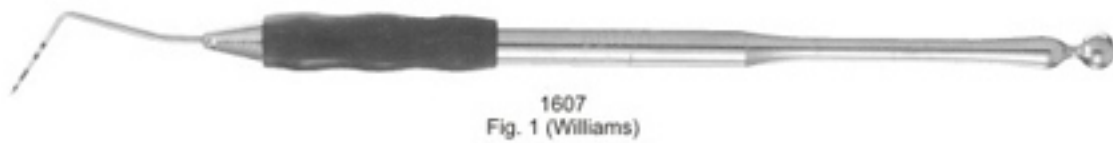
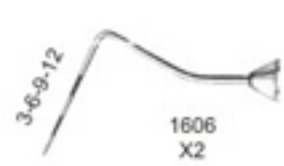
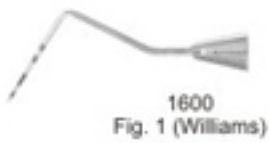
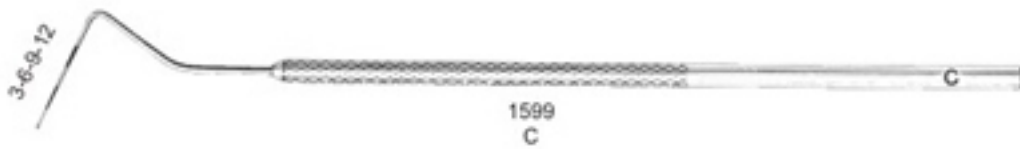
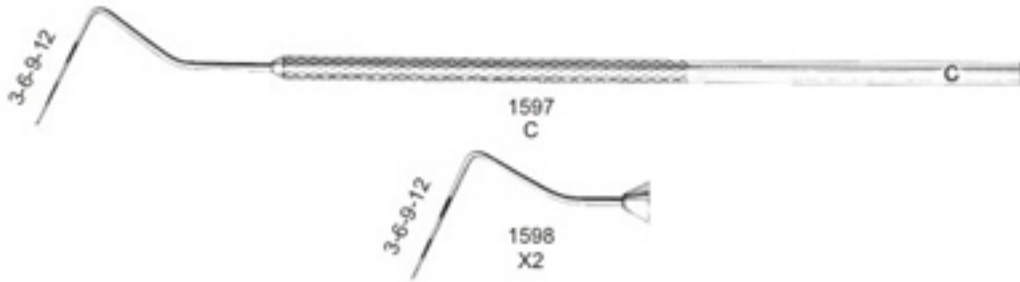

PROBES DOUBLE ENDED STANDARD

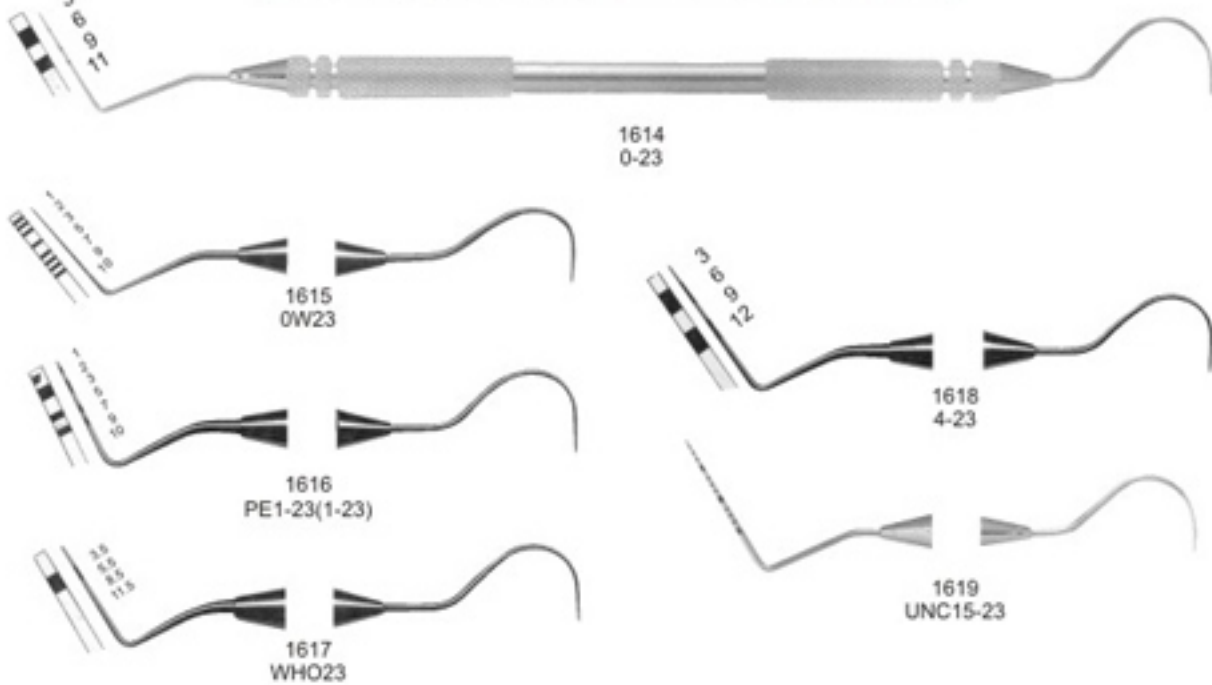

PROBES DOUBLE ENDED TACTILE TONE

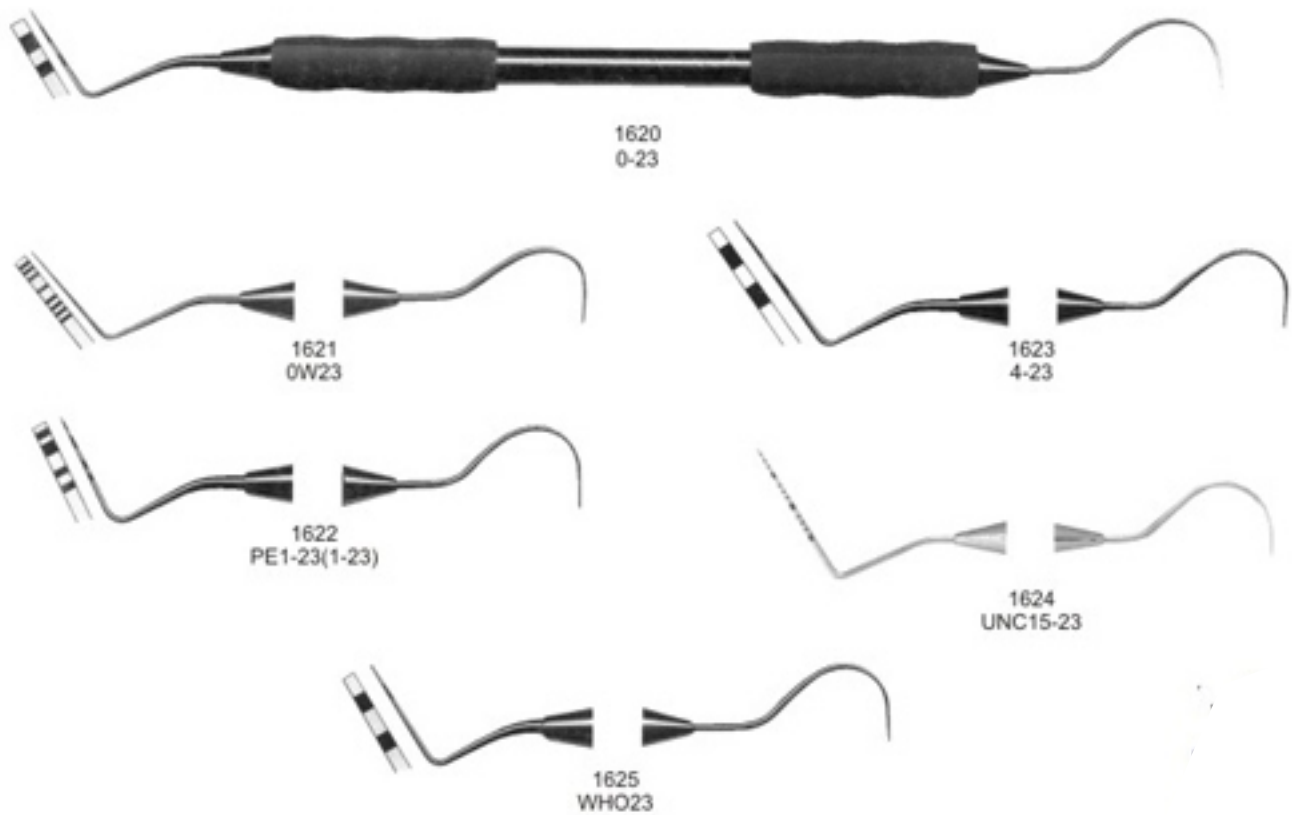

Endodontic Condensers

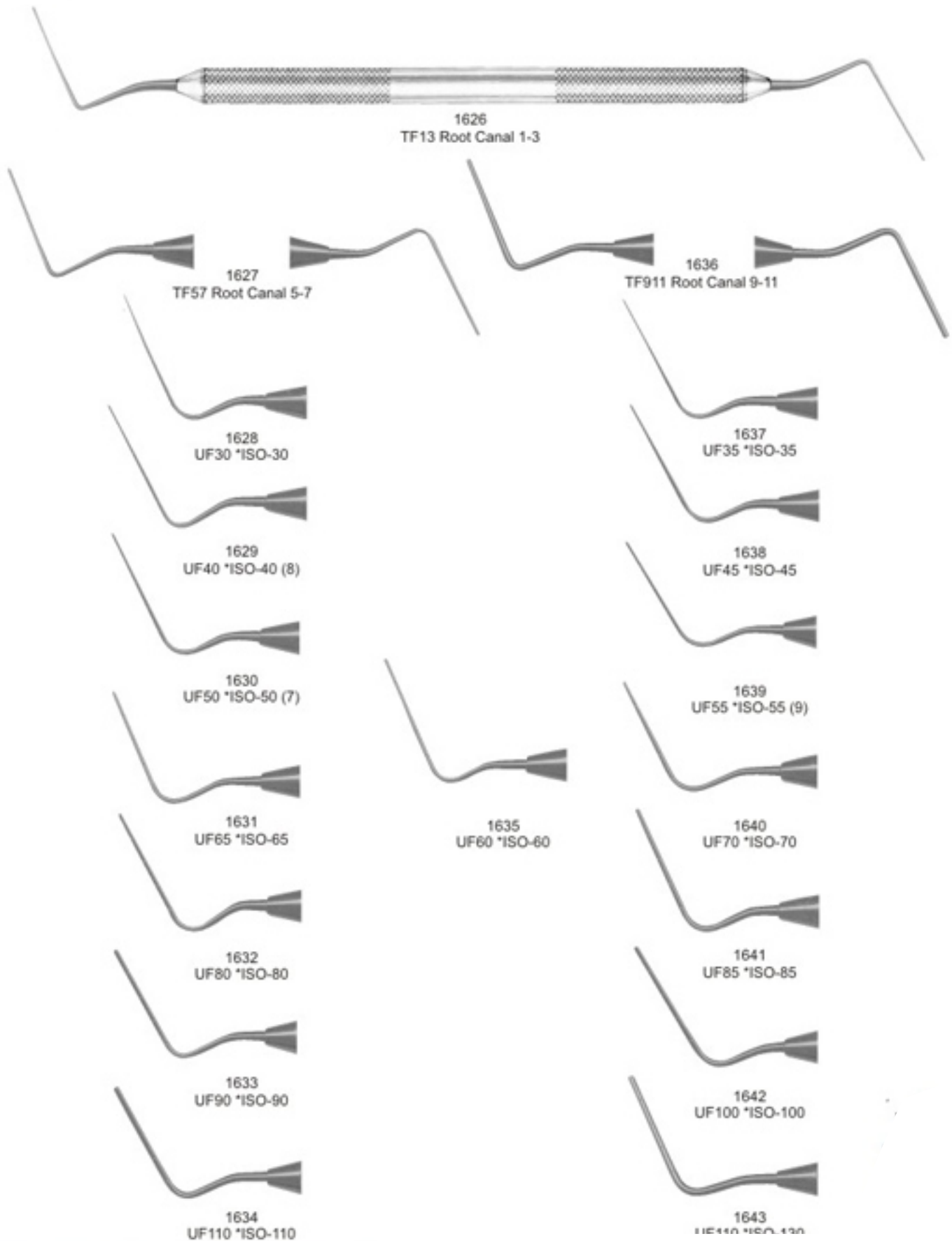

Endodontic Condensers/Spreaders

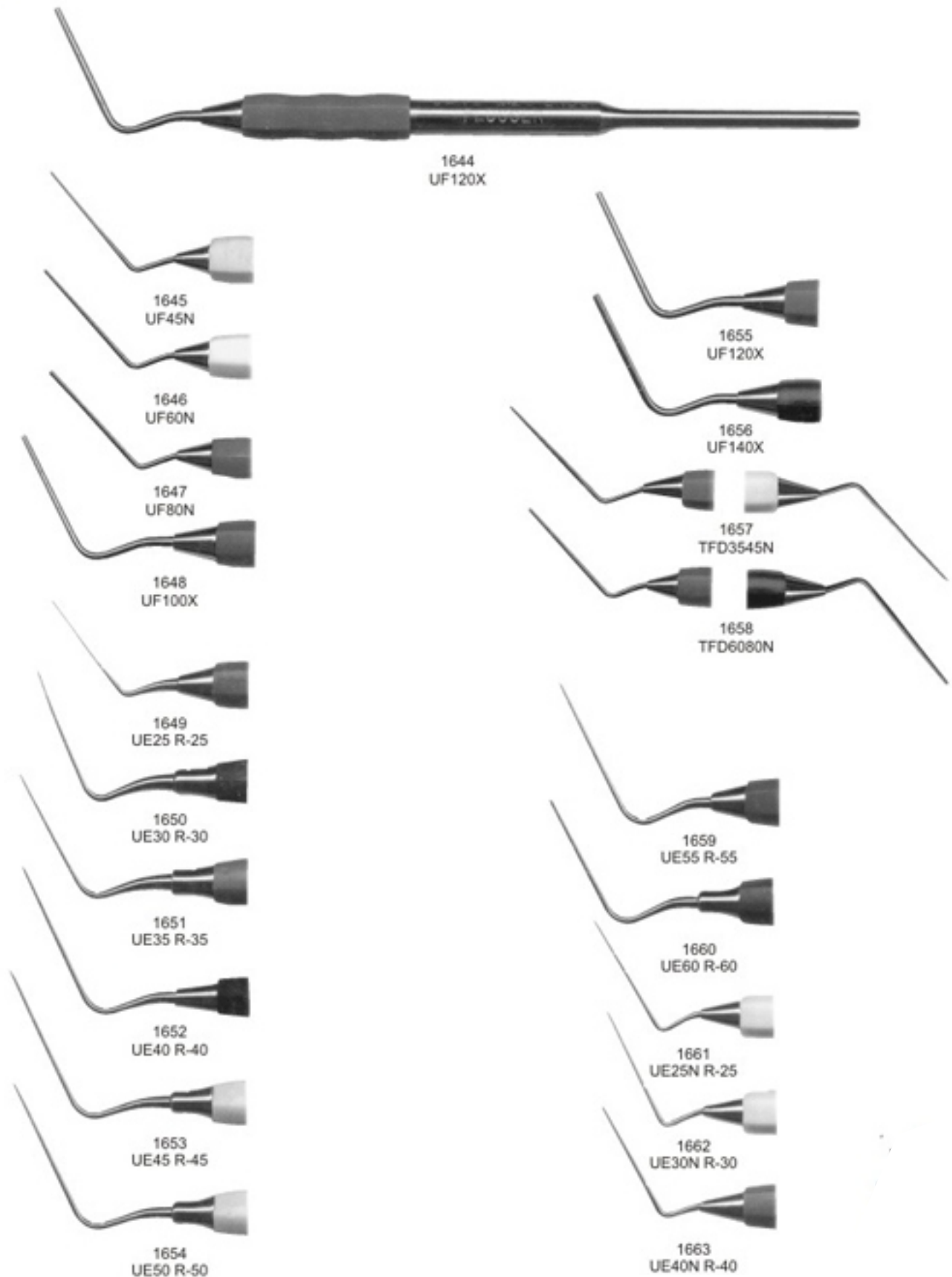

Obturation Instruments

1664
No. D11



1665
No. D11T



1666
No. KR1



1667
No. 25S



1668
No. W1S



1669
No. W2S

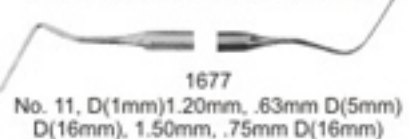
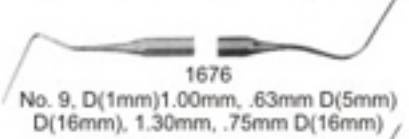
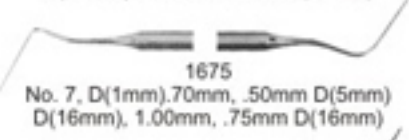
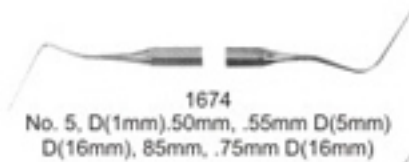

1670
Lucks No.1



1671
Lucks No.2



1672
Lucks No.3



1673
Lucks No.4



1682
No.1-3 - D1 .25mm/D1 .35mm



1683
No.3-5 - D1 .35mm/D1 .55mm

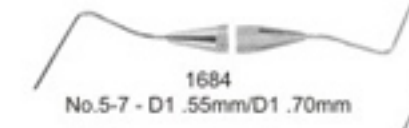

1684
No.5-7 - D1 .55mm/D1 .70mm

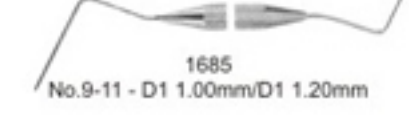

1685
No.9-11 - D1 1.00mm/D1 1.20mm

Excavators

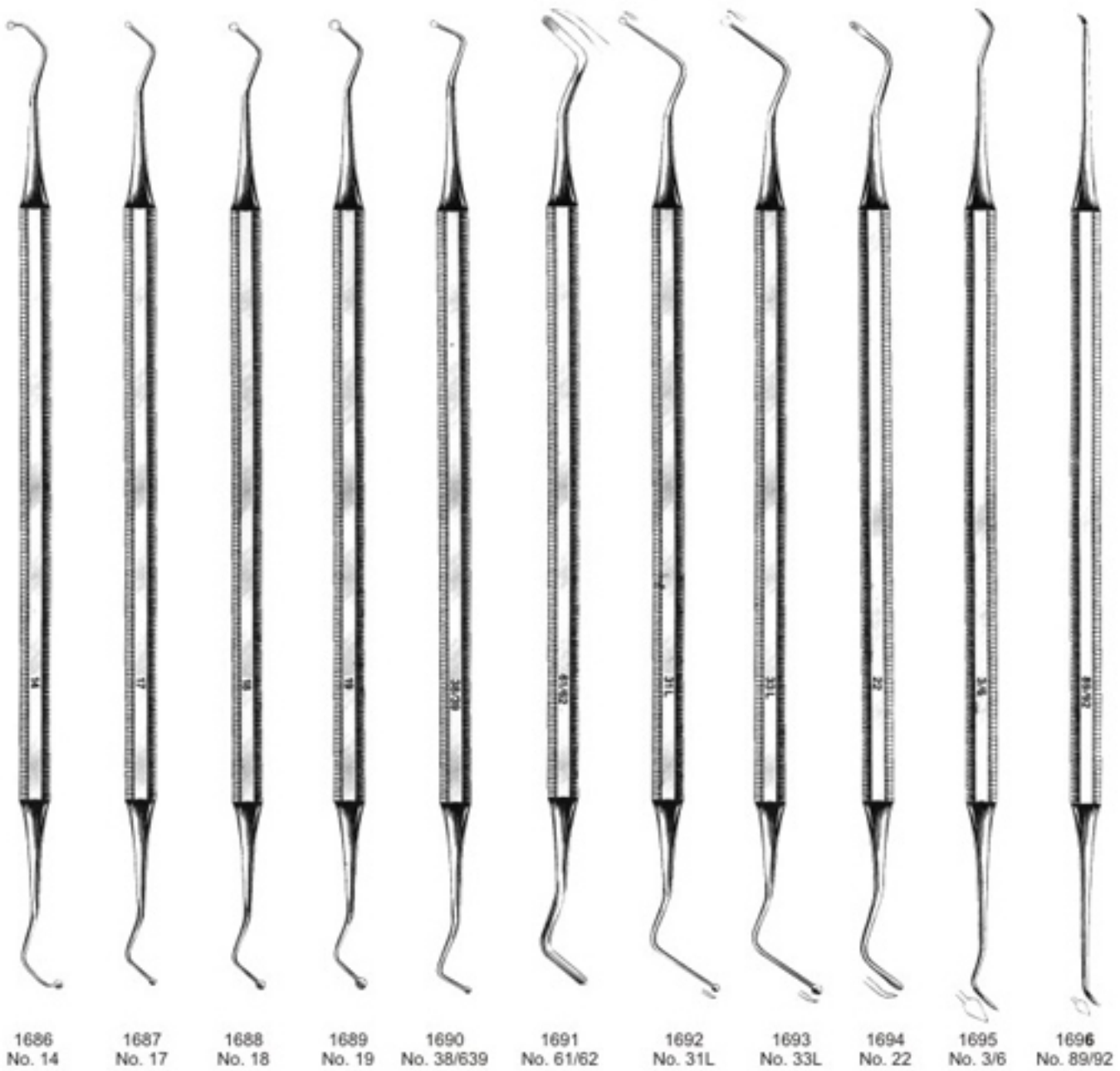

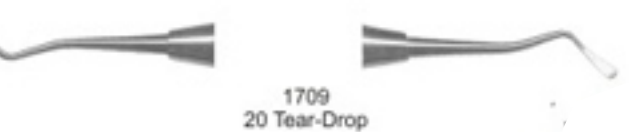
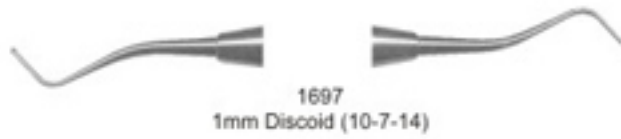

Excavators

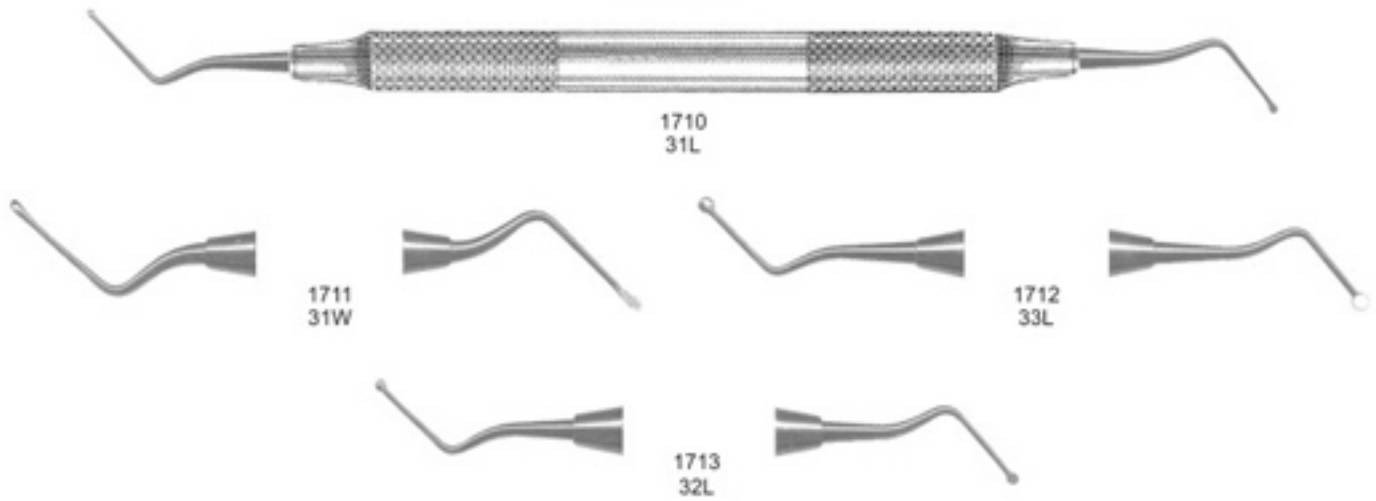

Explorers / Probes

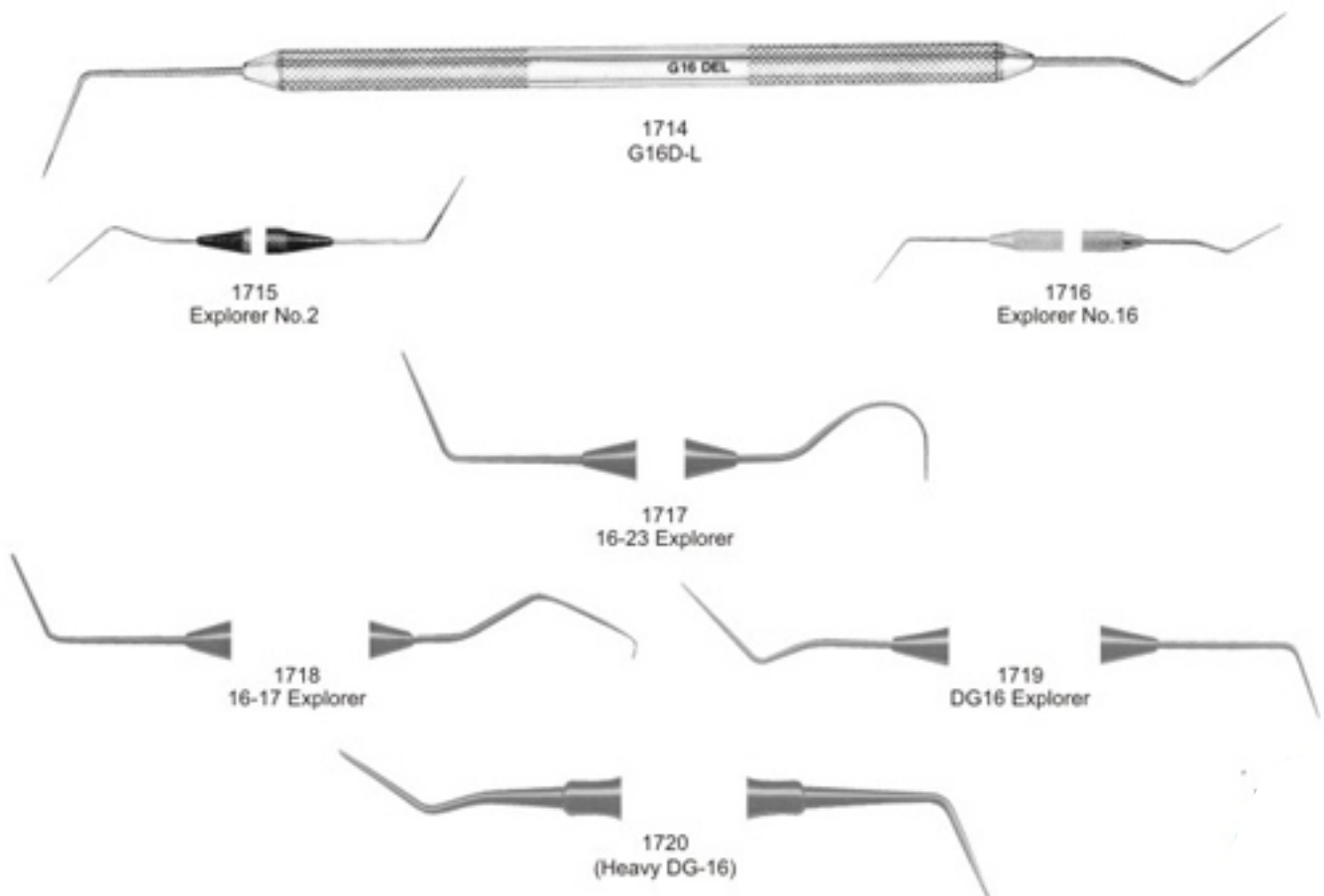



Explorers

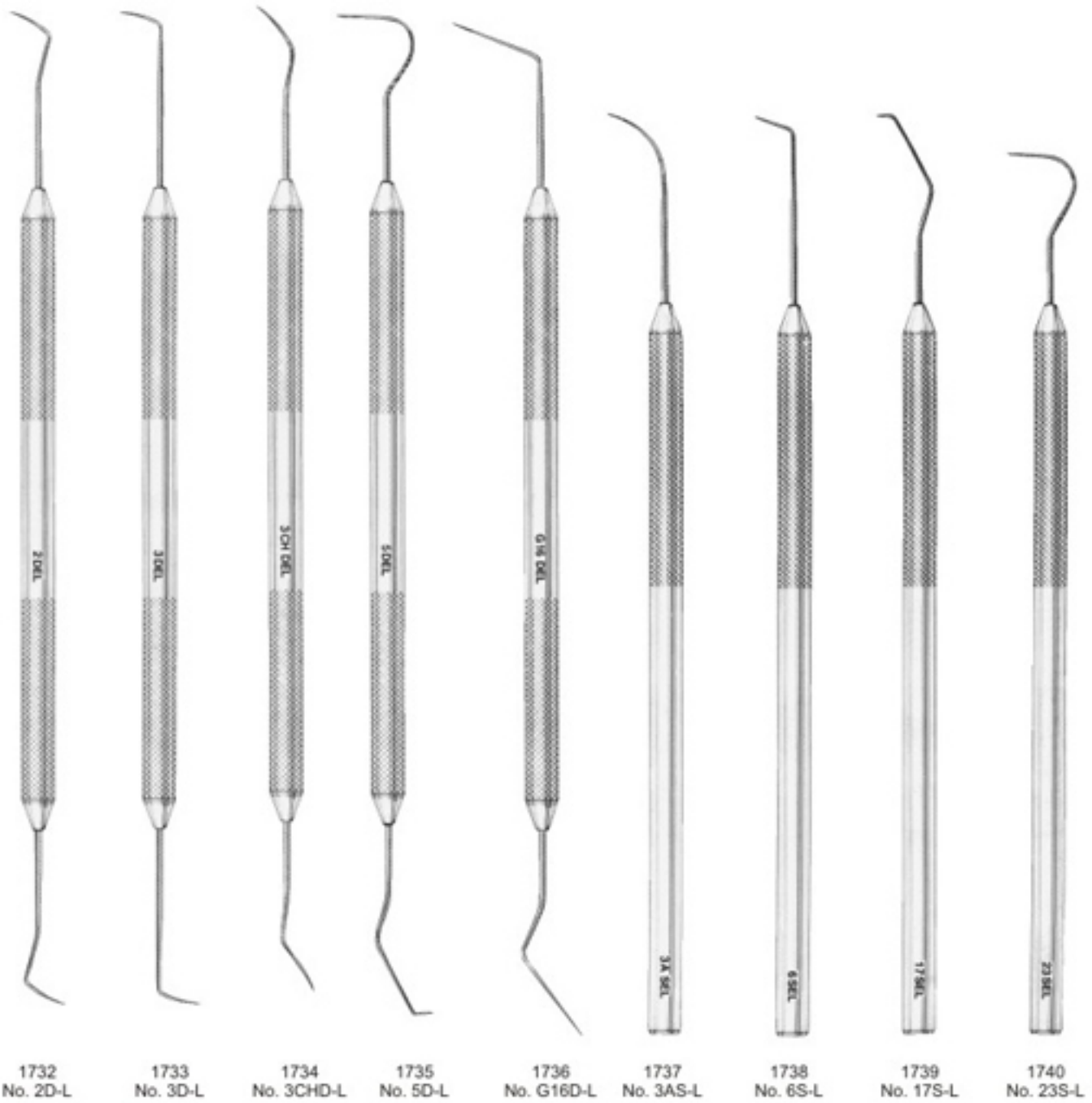



1741
Gf17 Probe/Explorer

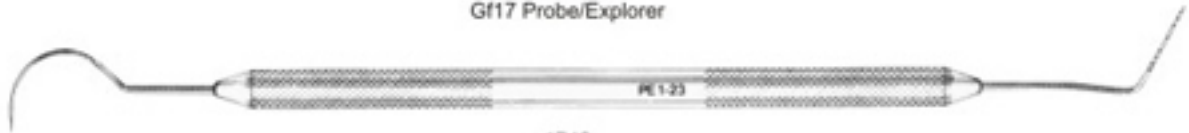

1742
PE 1-23 Probe/Explorer

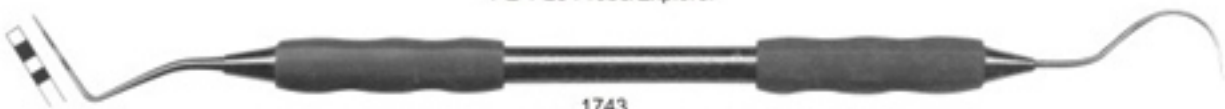

1743
Probe 0 / 23 Explorer (fine)



1744
Probe 1 / 23 Explorer



1746
Probe 4 / 23 Explorer



1745
Probe OW / 23 Explorer



1747
Ball Tip Probe WHO / 23 Explorer

PROBES



1748
Gf18 Probe



1749
'C' Probe



1750
X2 Probe



1751
1-2 (Probe 2 end is flat)



1752
1 UNC 15



1753
4 SE

CORD PACKERS



1754

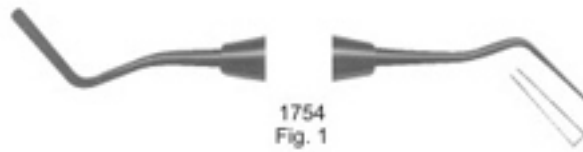

1754
Fig. 1



1755
Fig. 2



1756
Fig. 1



1757
BLOOMFIELD
Fig. 2 (off angle)



1758
CSI-1 (slightly serrated on ends)



HATCHETS



1759
1mm (10-7-14)



1760
1.3mm (13-10-16)



1761
1.5mm (15-8-14)

HOES



1762
1mm (10-8-16)



1763
UWH 18-19



1764
UWH 16-18



1765
UWH 20-21



Amalgam Pluggers / Condensers / Applicators



1766
BEHRMAN (Fig. 1)



1767
BLACK (Fig. 1-2)



1768
MORQUETTE (Fig. 0/1)



1769
Black Action 11/12 Plugger



1770
Hollenback No. 1 Plugger



1771
Hollenback No. 2 Plugger

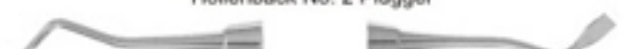

1772
Hollenback No. 3 Plugger



1773
Blacks 0-1 (1mm-1.5mm)



1774
Blacks 1-2 (1.5mm-2.5mm)

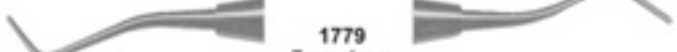

1779
.7mm-1mm



1775
Bodkin 1 (.7mm-1mm)

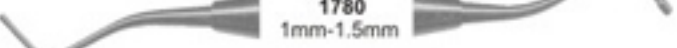

1780
1mm-1.5mm



1776
Bodkin 2 (1.5mm-2mm)

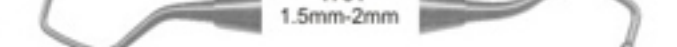

1781
1.5mm-2mm



1777
2.5mm-3mm

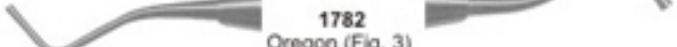

1782
Oregon (Fig. 3)

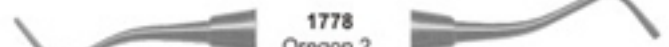

1778
Oregon 2

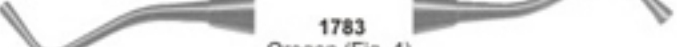

1783
Oregon (Fig. 4)

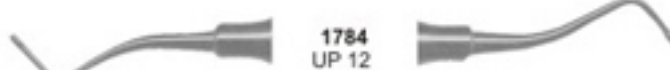

1784
UP 12



1785
Applicator 1-2



1786
Birtles Applicator Spatula



1787
Birtles Applicator Spatula K

Section - 03

- * Burnishers * Carvers * Chisels
- * Composite Placements
- * Filling Instruments * Curettes
- * Disposable Instruments



Burnishers

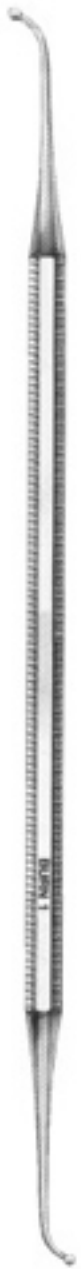

1788
Fig. 1



1789
Fig. 28/29



1790
Fig. 34

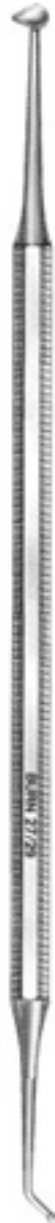

1791
Fig. 27/29



1792
Fig. 21B



1793
ACORN
Fig. 21

Burnishers

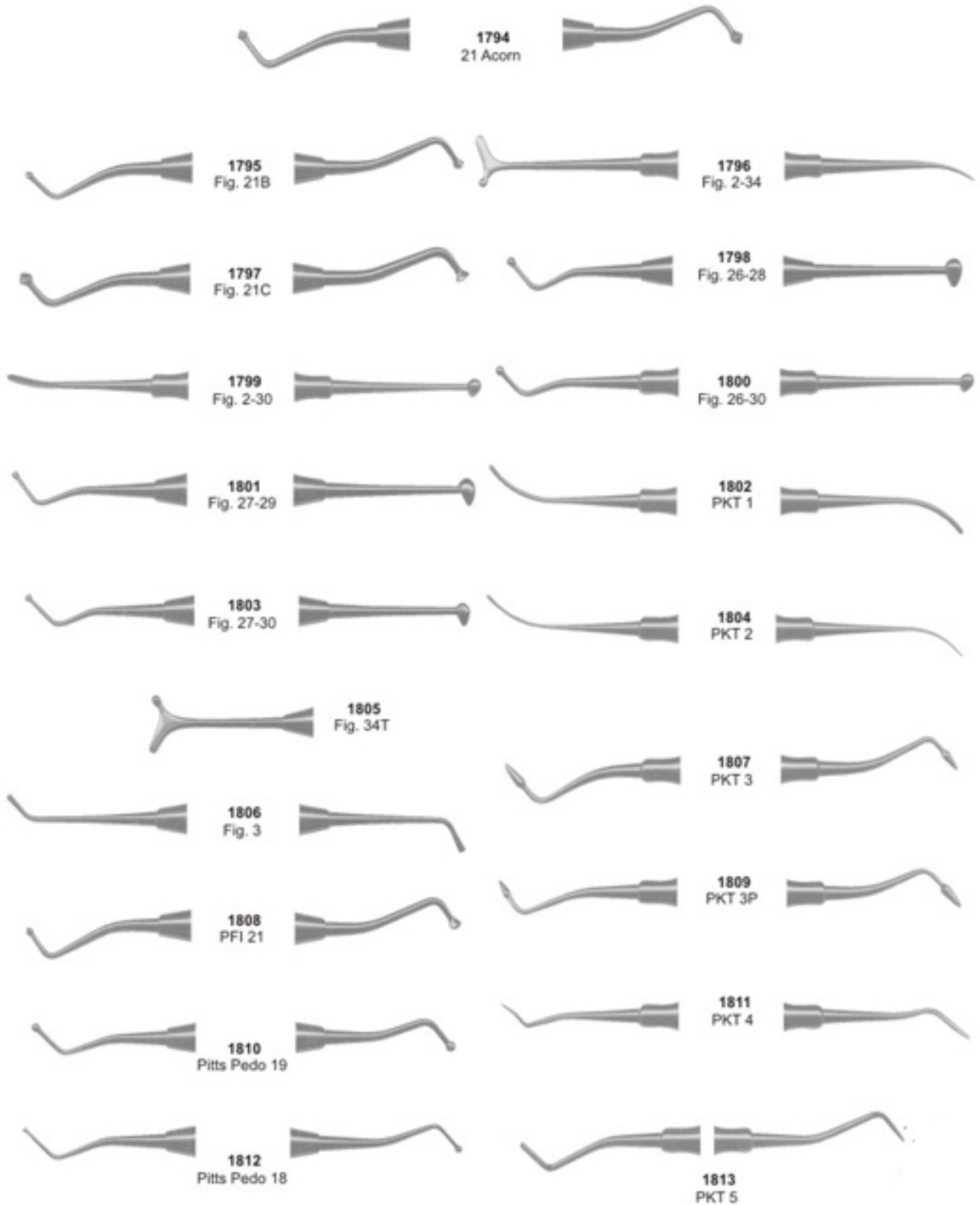

Wax Carvers



1814
HOLLENBACK
Fig. 3

1815
HOLLENBACK
Fig. 3S

1816
WARD
Fig. 1

1817
WARD
Fig. 2

1818
WALL
Fig. 1

1819
WALL
Fig. 3

1820
Fig. 3/6
Cleoid/Discoïd

1821
Fig. 89/92
Cleoid/Discoïd



1822
1.5mm Cleoid Discoid (Shown with GTX Finish)



1823
2mm Cleoid Discoid



1831
GOLLOBIN
Fig. 1



1824
3mm Cleoid Discoid



1832
HOLLENBACK
Fig. 1/2



1825
FRAHM
Fig. 2-3 (off-angle)



1833
HOLLENBACK
Fig. 3



1826
Interproximal 1



1834
THOMPSON (Fig. 3)
($\frac{1}{2}$ Hollenback Hoe & Wall 3)



1827
Interproximal 1



1835
THOMPSON (Fig. 5)
($\frac{1}{2}$ Hollenback Hoe & Tanner 5)



1828
Baum Interproximal



1836
THOMPSON (Fig. 8)
(3mm Cleoid & Wall 3)



1829
Sho A Carver



1837
THOMPSON (Fig. 9)
(Hollenback 3 & Wall 3)



1830
Thompson 2



1838
WARD
Fig. 2



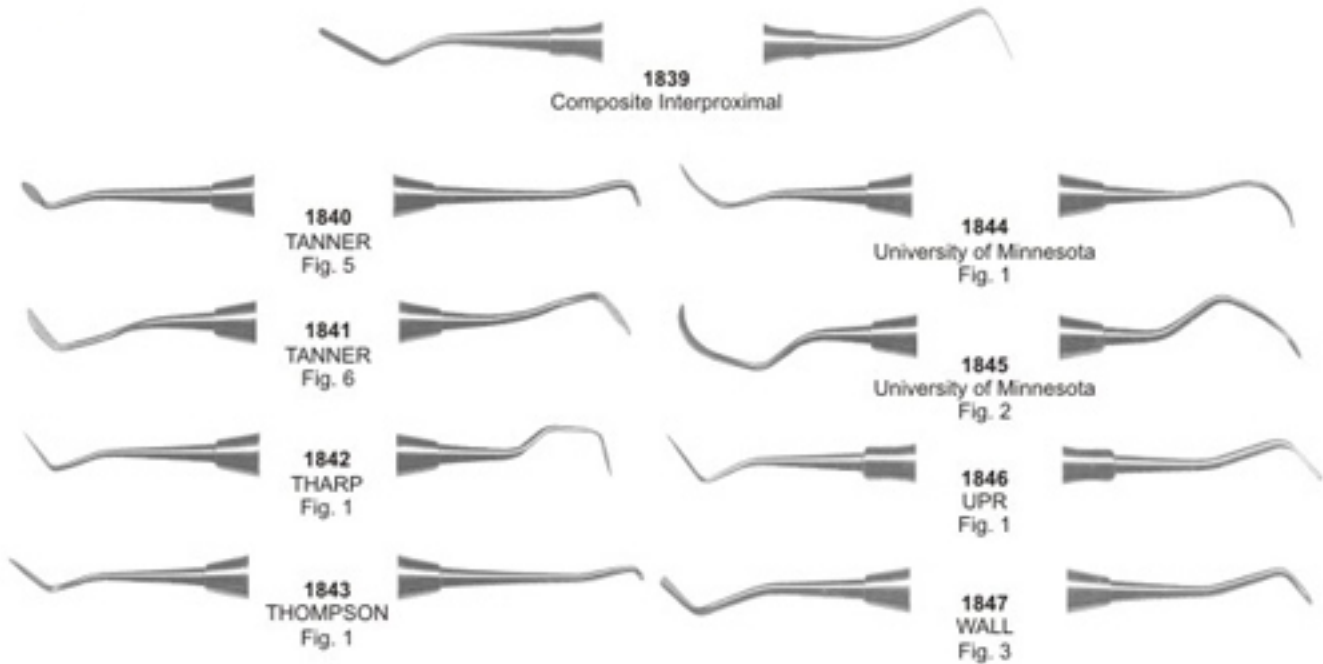

Contour Carbide Carvers - Finishing

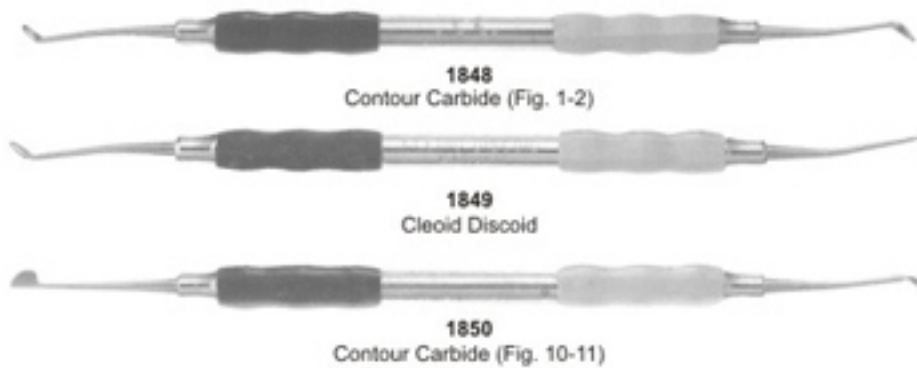

Chisels

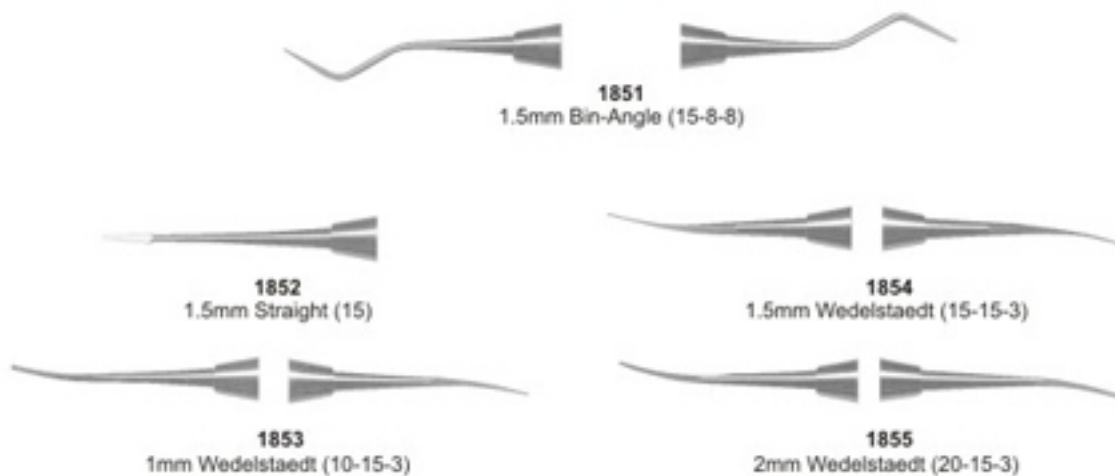

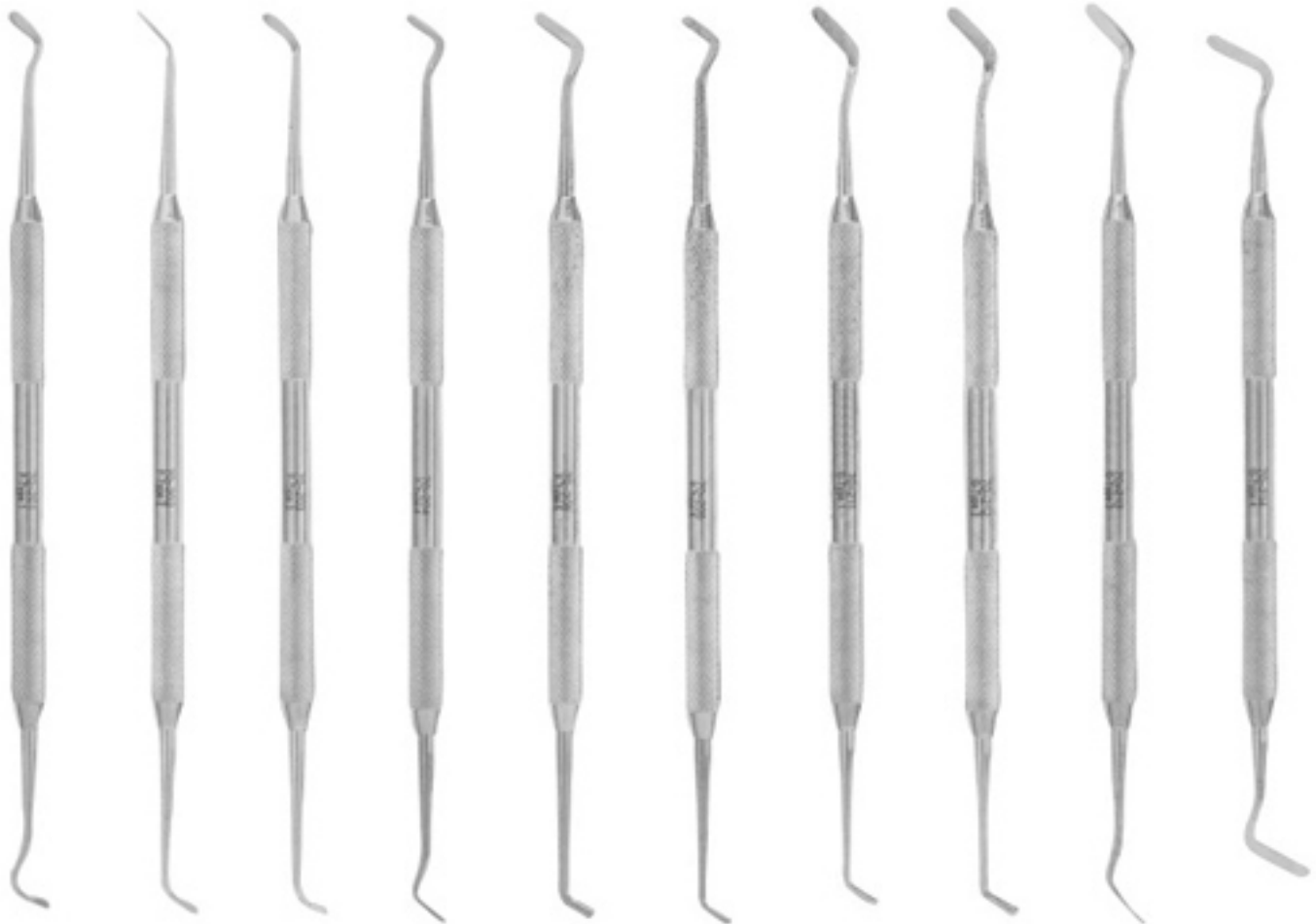

1856
F-Type 1

1857
F-Type 2

1858
F-Type 3

1859
F-Type 4

1860
F-Type 5

1861
F-Type 6

1862
G-Type 1

1863
G-Type 2

1864
G-Type 3

1865
G-Type 4



1866
Fig. 2



1867
Fig. 3 (off-set blade)



1868
Fig. 4



1875
Fig. 12



1876
Fig. 15



1869
Fig. 5



1877
JORDAN
Fig. 2



1878
FREEDMAN
Fig. 1



1879
FREEDMAN
Fig. 2



1870
Fig. 6



1880
FREEDMAN
Fig. 3



1881
Dr. Dan



1882
SIMON
Fig. 2



1871
Fig. 7



1872
Fig. 8



1873
Fig. 9



1874
Fig. 11

K - Type

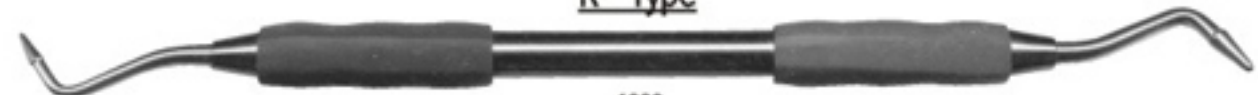

1883
K-Type 1



1884
K-Type 2



1886
K-Type 4



1885
K-Type 3



1887
K-Type 5



1888
K-Type 6 Carbide

Plastic Filling Instruments

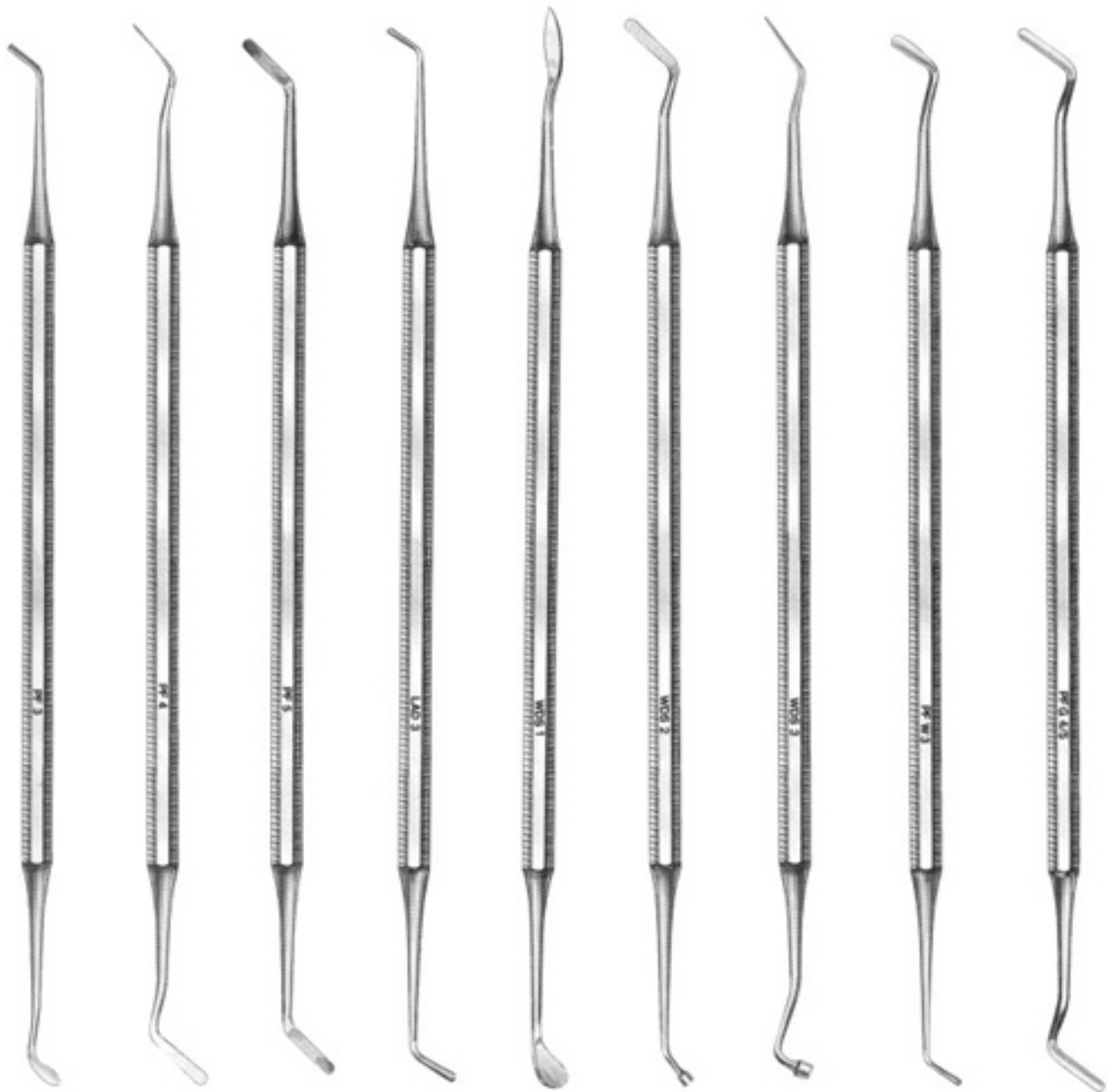

1889
No.3

1890
No.4

1891
No.5

1892
LADMORE
Fig. 3

1893
WOODSON
Fig. 1

1894
WOODSON
Fig. 2

1895
WOODSON
Fig. 3

1896
W-3

1897
Gregg
4/5

Plastic Filling Instruments



1898
Fig. 5-7



1899
Fig.1



1900
Fig. 3



1904
GLICK
Fig.1



1901
Fig. 4



1905
P8



1902
Fig. 5-7



1906
WOODSON
Fig. 1



1903
Fig. 8A



1907
WOODSON
Fig. 2



1908
WOODSON
Fig. 3



Curettes

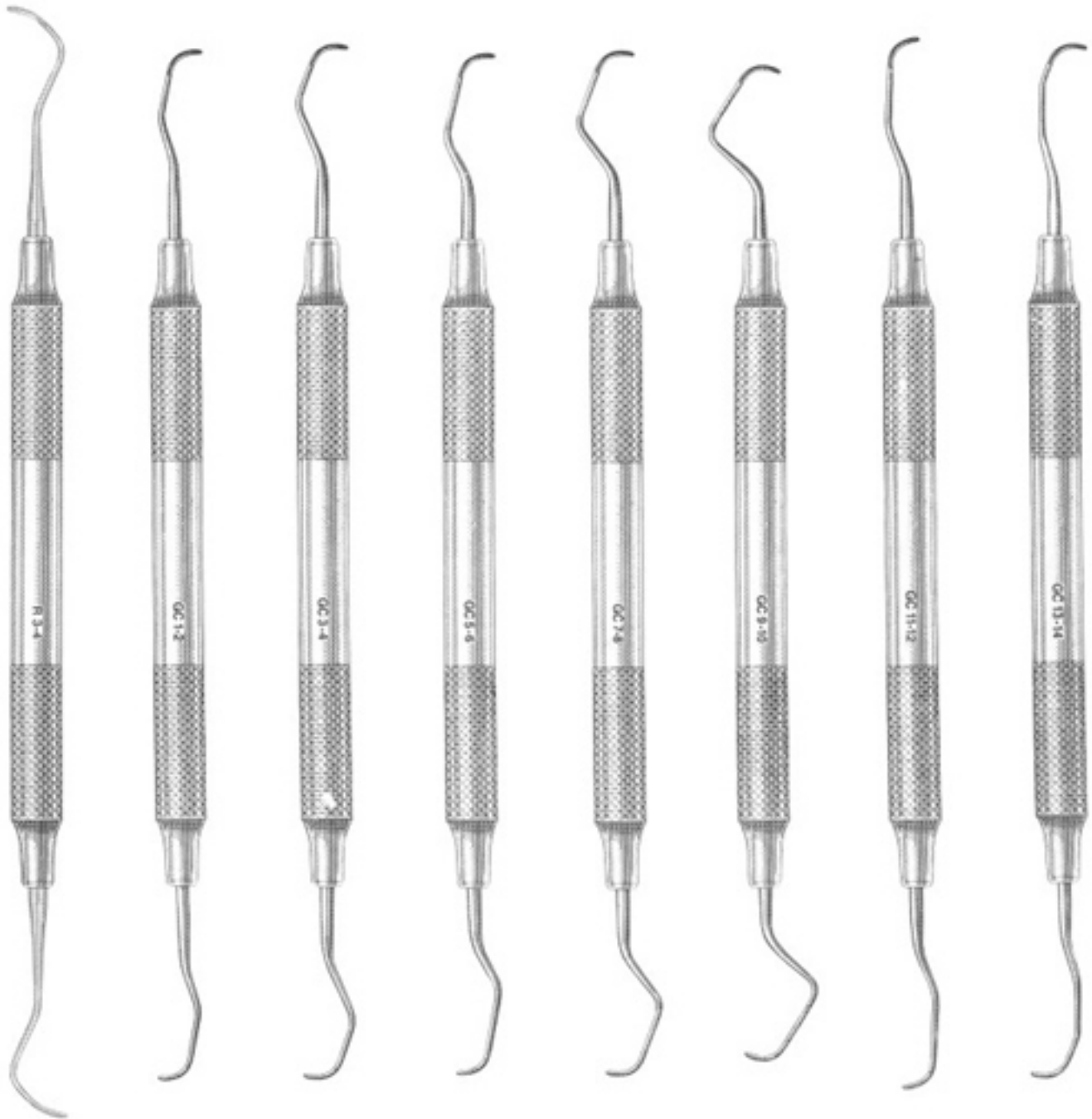

1909
RULE
3-4

1910
GRACEY
GC 1-2

1911
GRACEY
GC 3-4

1912
GRACEY
GC 5-6

1913
GRACEY
GC 7-8

1914
GRACEY
GC 9-10

1915
GRACEY
GC 11-12

1916
GRACEY
GC 13-14

Gracey Curettes

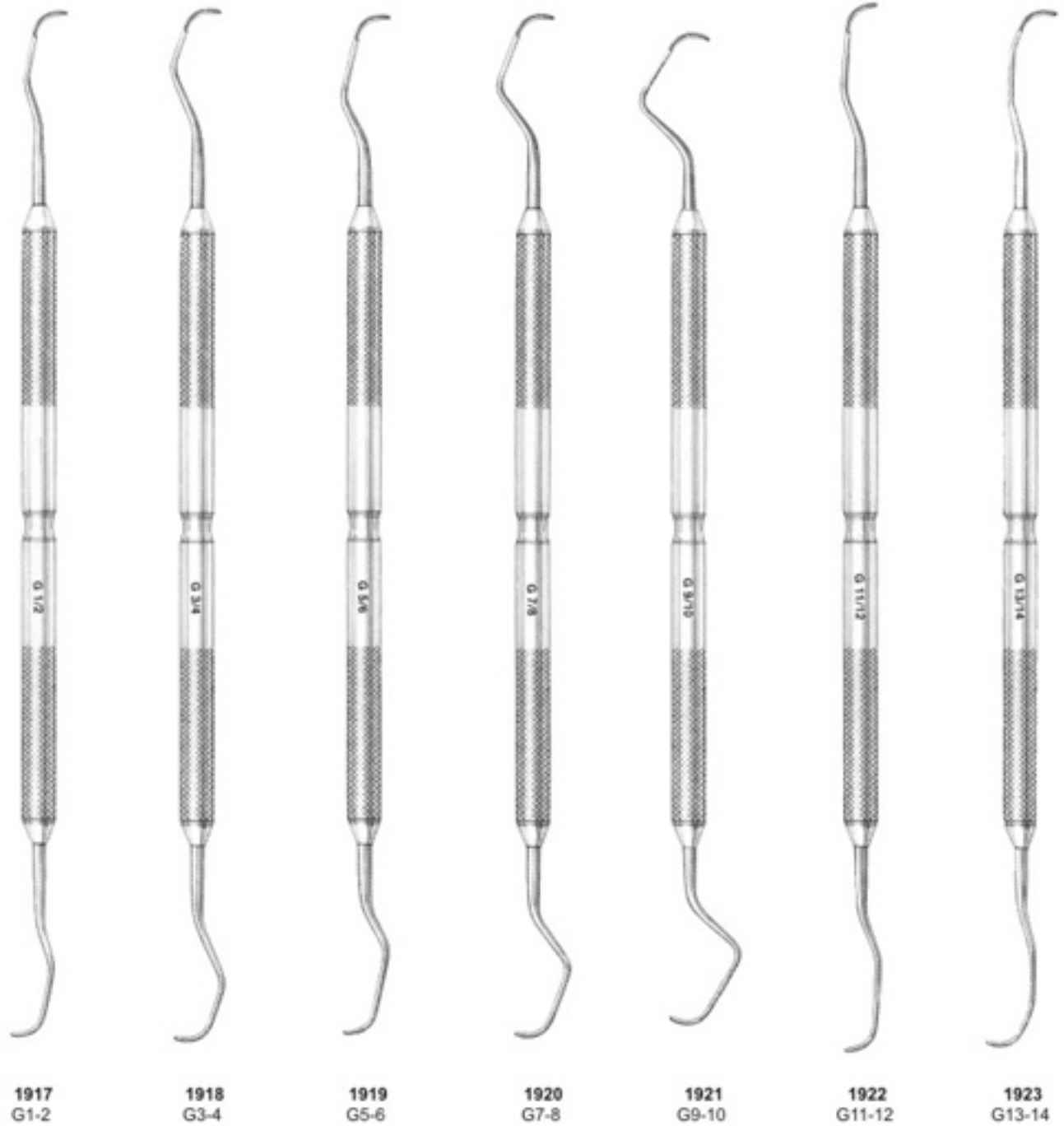

Curettes # 4 Handle

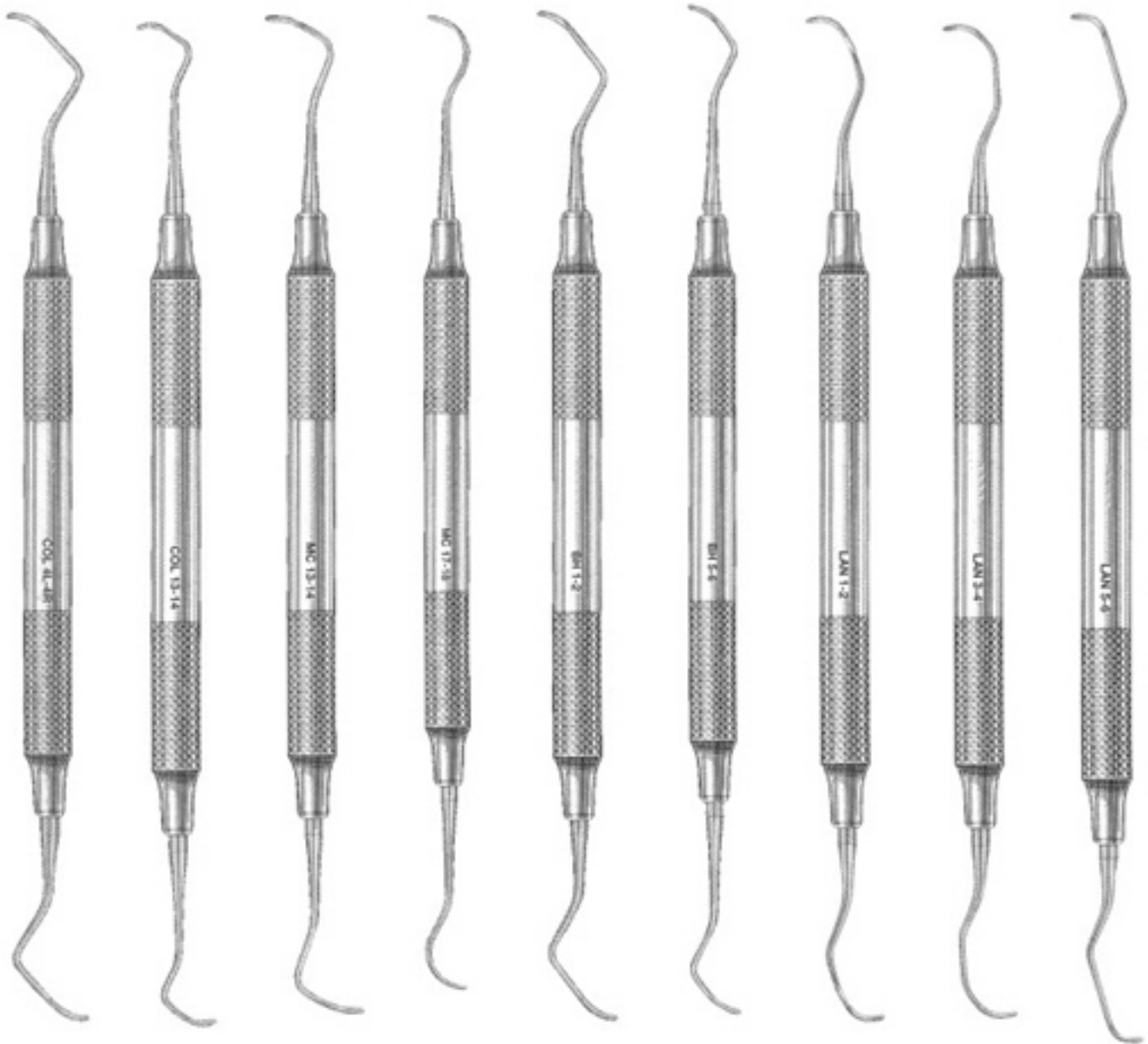

1924
COLUMBIA
4R-4L

1925
COLUMBIA
13-14

1926
MCCALLS
13-14

1927
MCCALLS
17-18

1928
BARNHART
1-2

1929
BARNHART
5-6

1930
LANGER
1-2

1931
LANGER
3-4

1932
LANGER
5-6

COLUMBIA CURETTES



1933
4L-4R

1934
13-14

1935
2L-2R

MCCALLS CURETTES



1936
13-14

1937
13S-14S

1938
17-18

1939
17S-18S

GOLDMAN FOX



1940
GF1 Universal Scaler



1941
GF2 Curette



1942
GF3 Curette



1943
GF4 Curette



1944
GF5 Hoe



1945
GF6 Hoe

GOLDMAN FOX

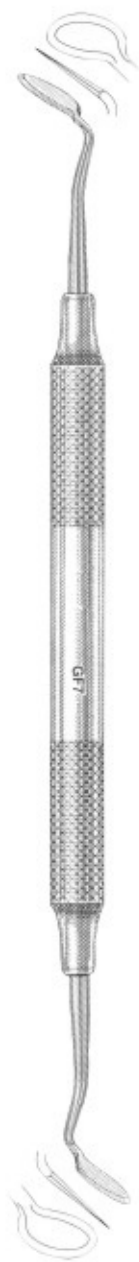

1946
GF 7 Knife

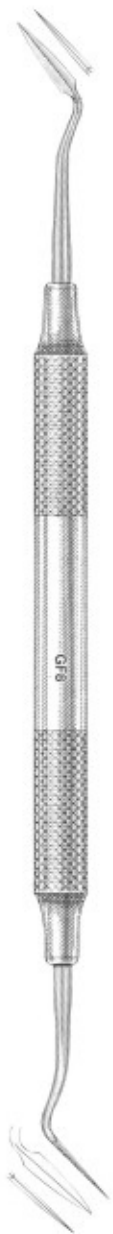

1947
GF 8 Spear Knife

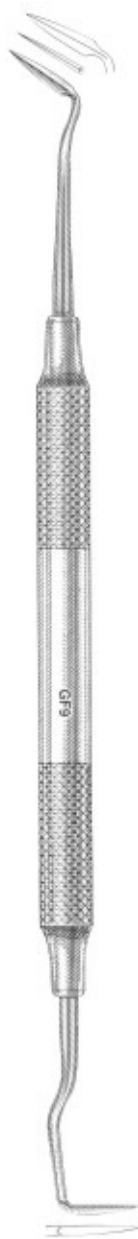

1948
GF 9 Knife Scaler



1949
GF 11 Spear Knife



1950
GF 21 Sharp Spoon /
Small Scaler



1951
COLUMBIA (2L-2R)



1952
MCCALL (13-14)



1953
MCCALL (17S-18S)

Root Planning Curettes



1954
Root Plane (1-2)



1955
Root Plane (5-6)



1957
Root Plane (11-12)



1956
Root Plane (7-8)



1958
Root Plane (13-14)



1959
Petite (1-2)



1960
Petite (11-12)



1961
Petite (5-6)



1962
Petite (13-14)

Curettes



1963
BARNHART (1-2)



1964
BARNHART (5-6)



1973
COLUMBIA (4L-4R)



1965
GRACEY (1-2)

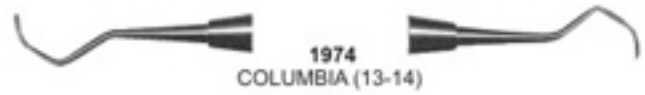

1974
COLUMBIA (13-14)



1966
GRACEY (3-4)



1975
LANGER (1-2)



1967
GRACEY (5-6)



1976
LANGER (3-4)



1968
GRACEY (7-8)



1977
LANGER (5-6)



1969
GRACEY (9-10)



1978
MCCALL (13-14)



1970
GRACEY (11-12)



1979
MCCALL (13S-14S)

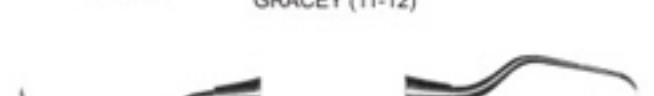

1971
GRACEY (13-14)

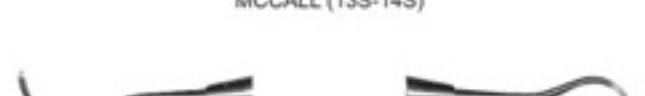

1980
MCCALL (17-18)

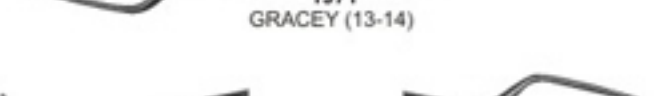

1972
GRACEY (2L-2R)

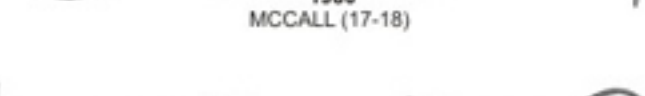

1981
MCCALL (17S-18S)



1982
RULE (3-4)

Silicon Handles-Reusable

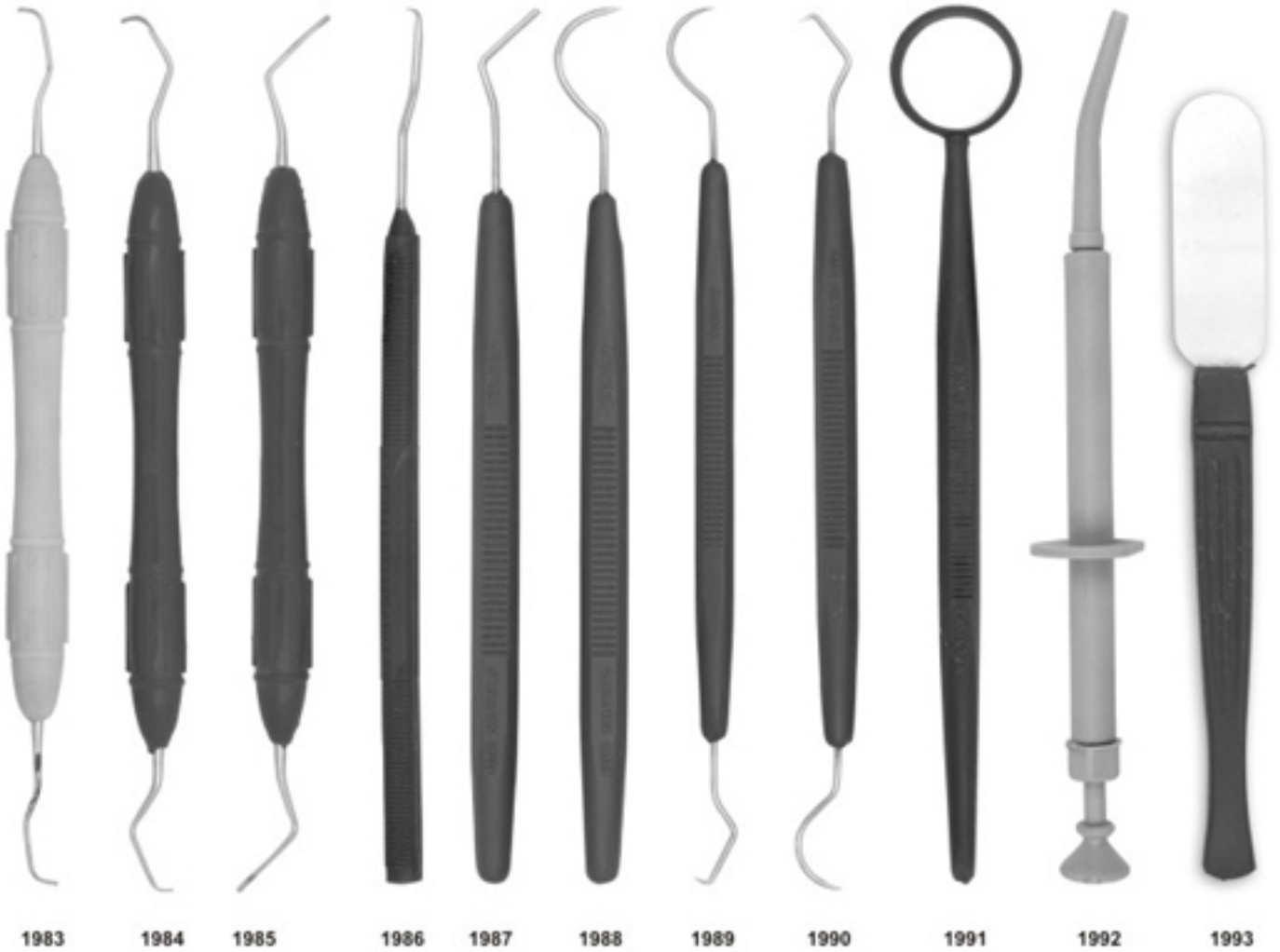

Section - 04

- * Cement Instruments * Spatulas
- * Knives * Bone Currettes & Files
- * Bone Chisels * Bone Mallets
- * Crown Remover
- * Implant Instruments



Comfort Grip
Vinyl - Covered Insulating Handles



P.K. THOMAS

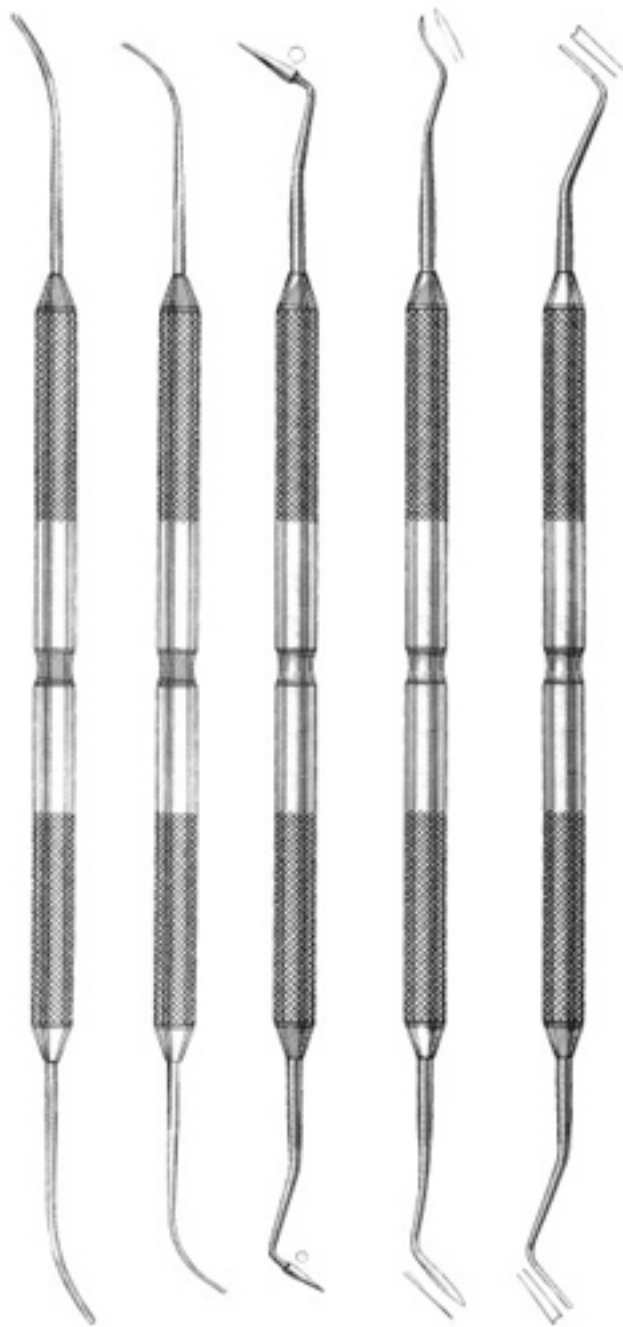

2009 PKT 1 2010 PKT 2 2011 PKT 3 2012 PKT 4 2013 PKT 5

Set of 5 instruments

WAX CARVERS

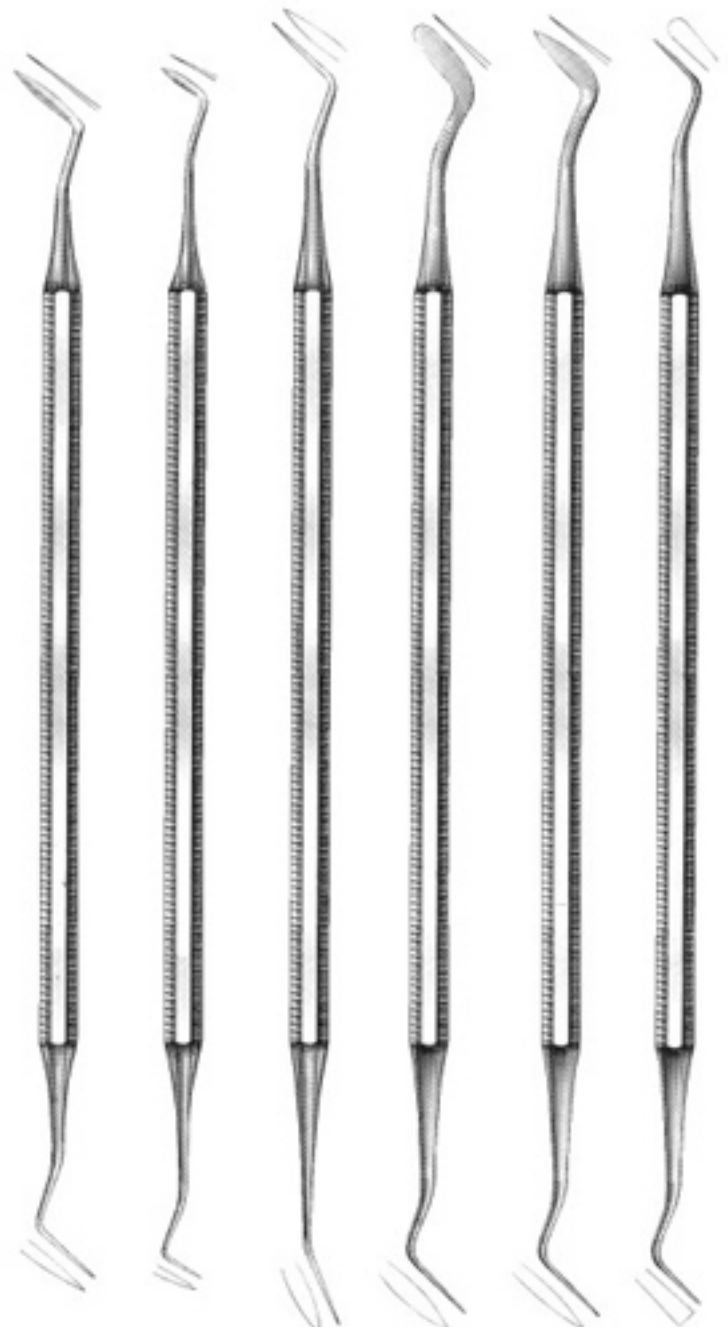

2014 Hollenback 3 2015 Hollenback 3S 2016 WARD 1 2017 WARD 2 2018 WALL 1 2019 WALL 3

Wax & Modeling Carvers, Cement Spatulas

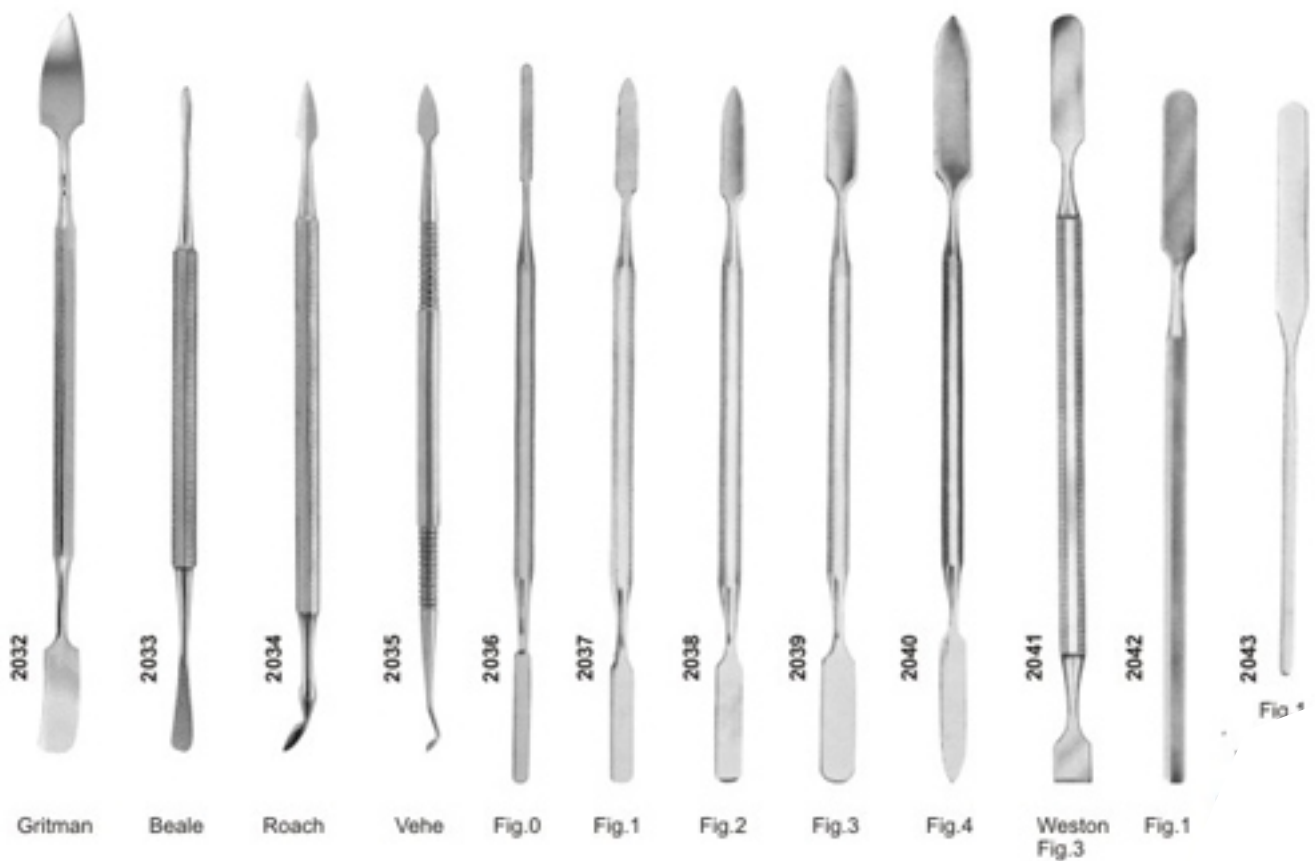
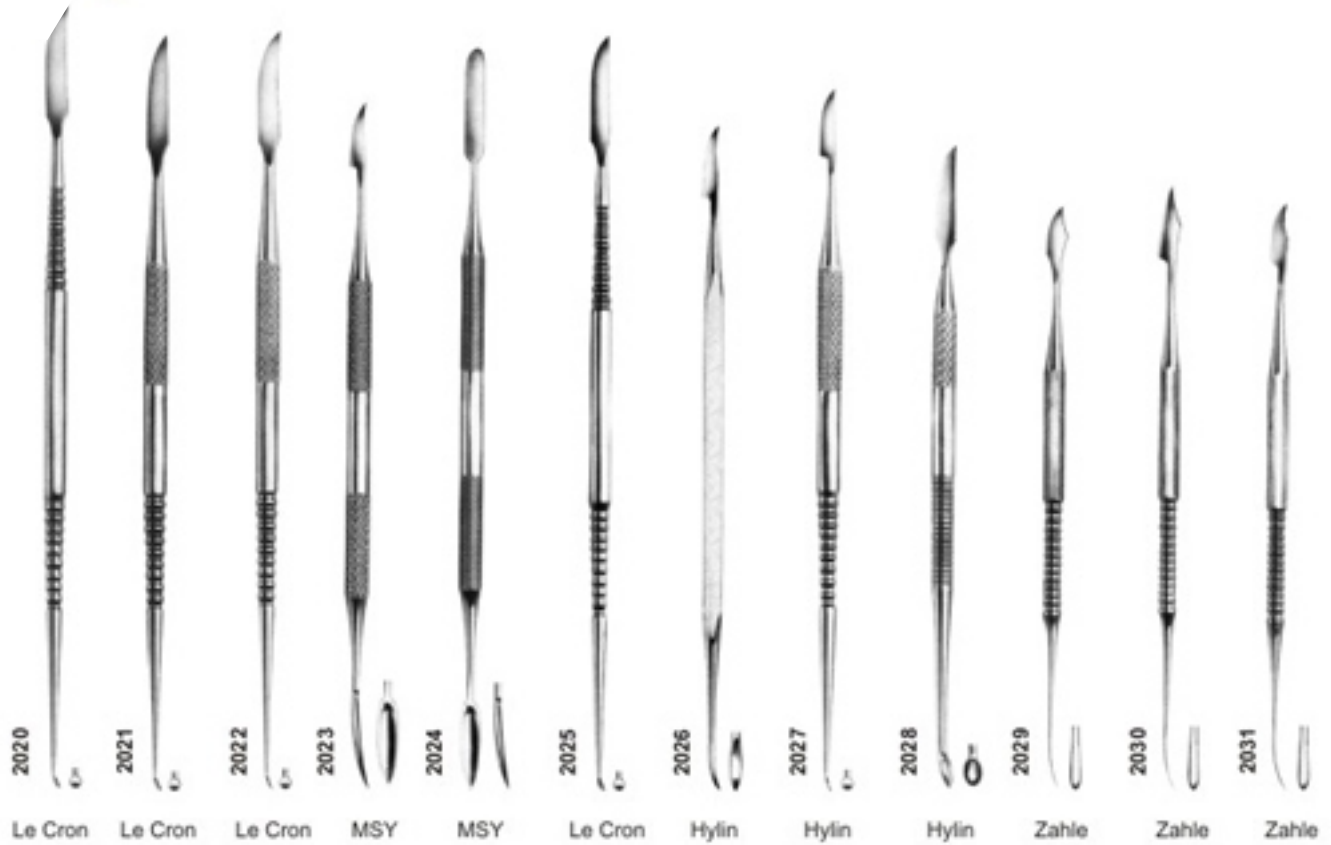

WAX & PORCELAIN CARVERS



2044
LECRON
Inlay

2045
REEVES

2046
VEHE
Wax

2047
ROACH
Wax

WAX SPATULAS



2048
W-31

2049
W-5

2050
W-7

2051
W-7A

2052
W

Cement Spatulas



2053
AGATHE



2054
C-7



2055
C-5



2056
C-313



2057
C-24A Rigid



2058
C-24 Flexible



2059
C-24 Flexible



2060
24



2061
A6



2063
7 Wax



2062
26



2064
All Metal Spatulas with High Polish
Stainless Steel Blade



2065
31

Spatulas



Spatulas



FILES

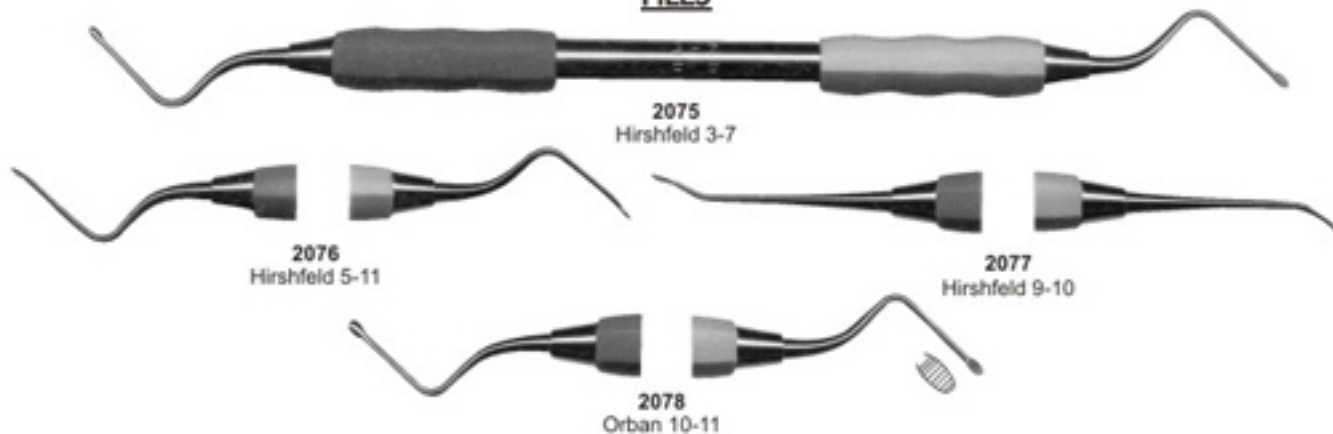

HOES

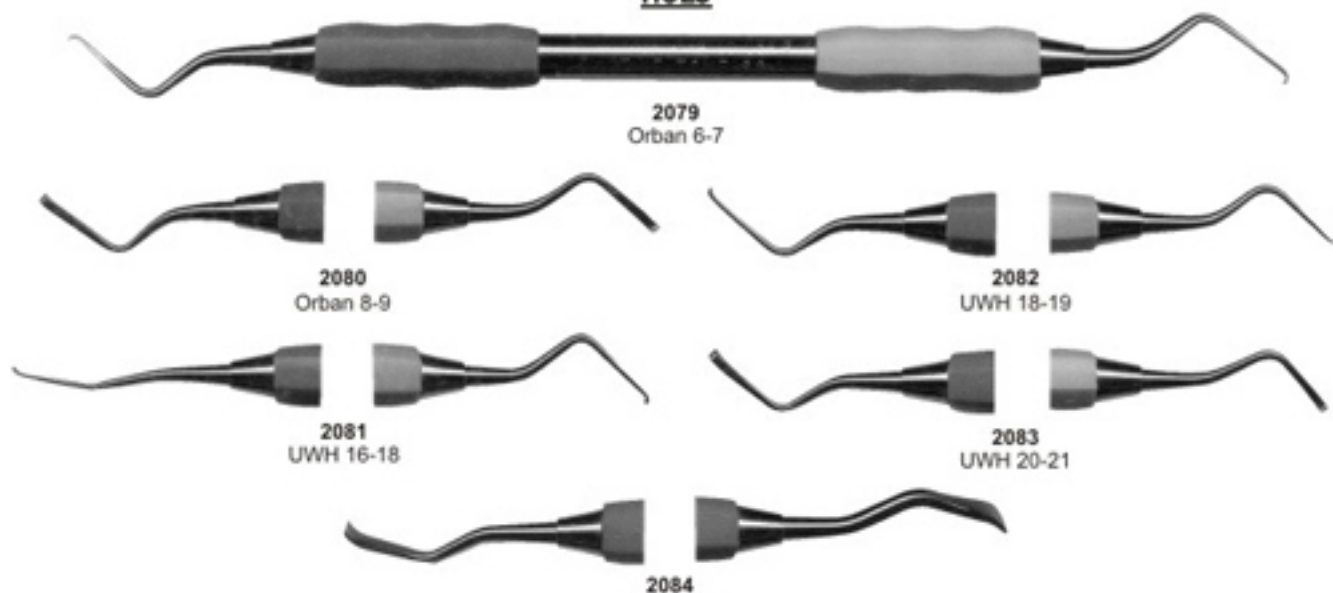

KNIVES

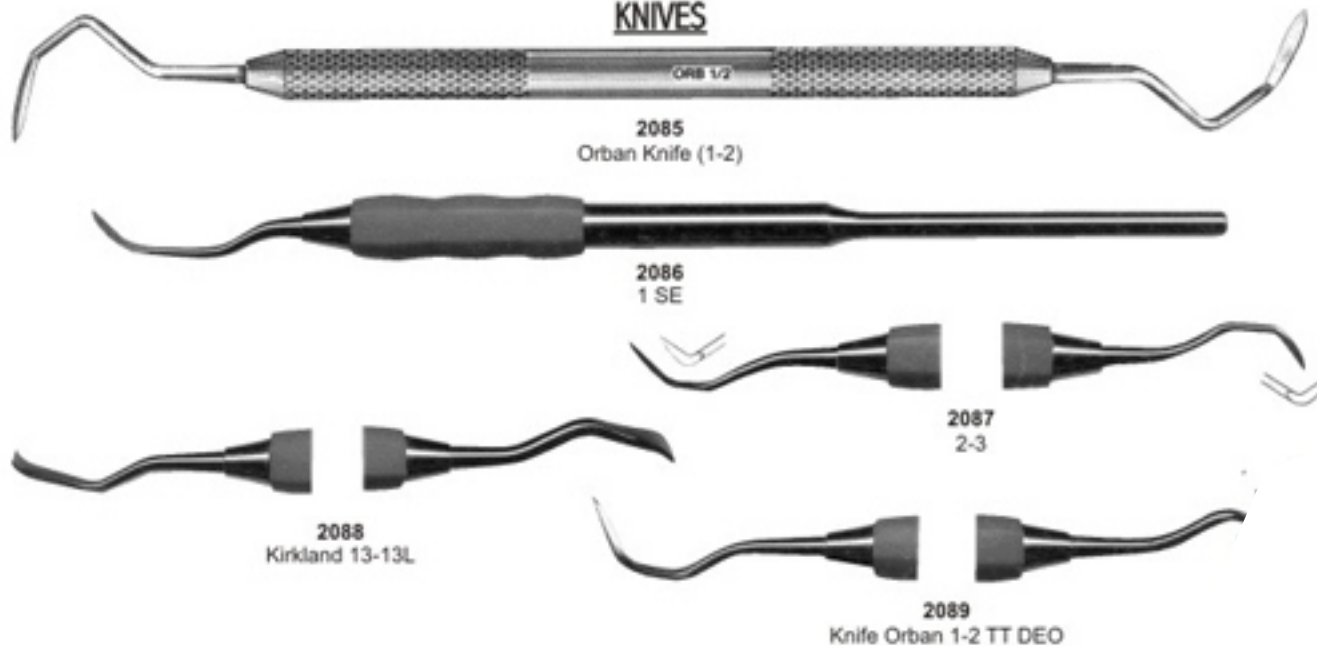

Wax Knives



2090
Fahnenstock
Fig. 1
12.5cm

2091
Fahnenstock
Fig. 2
17cm

2092
Lessmann
Fig. 1
12.5cm

2093
Lessmann
Fig. 2
17cm

2094
Con scodellino
Fig. 1
12.5cm

2095
Con scodellino
Fig. 2
17cm

2096
Ermert

2097
Ermert

Wax Knives & Plaster Knives



2098
18 cm
7 1/8"



2099
18 cm
7 1/8"



2100
17 cm
6 3/4"
Gritman



2101
17 cm
6 3/4"
Medicon



2102
Fig. 1
17 cm



2103
22 cm
8 3/4"



2104
22 cm
8 3/4"



2105
Gritman
Fig. 2
17 cm



2106
Fig. 3
16 cm



2107
Fig. 4
16 cm

CRANE-KAPLAN



2108
Ck1
Pocket Marker

2109
Ck2
Pocket Marker

2110
Knife

2111
Dissector

2112
Scaler

OCHSENBEIN



2113
Ochsenbein
Fig. 1

2114
Ochsenbein
Fig. 2

2115
Ochsenbein
Fig. 4

Bone Currettes



2116
No. 75

2117
No. 85

2118
No. 86

2119
No.87



2120
No. 2/4



2121
No.1



2122
No. 2

2123
No. 4

2124
No. 5L

2125
No.6R

Bone Files

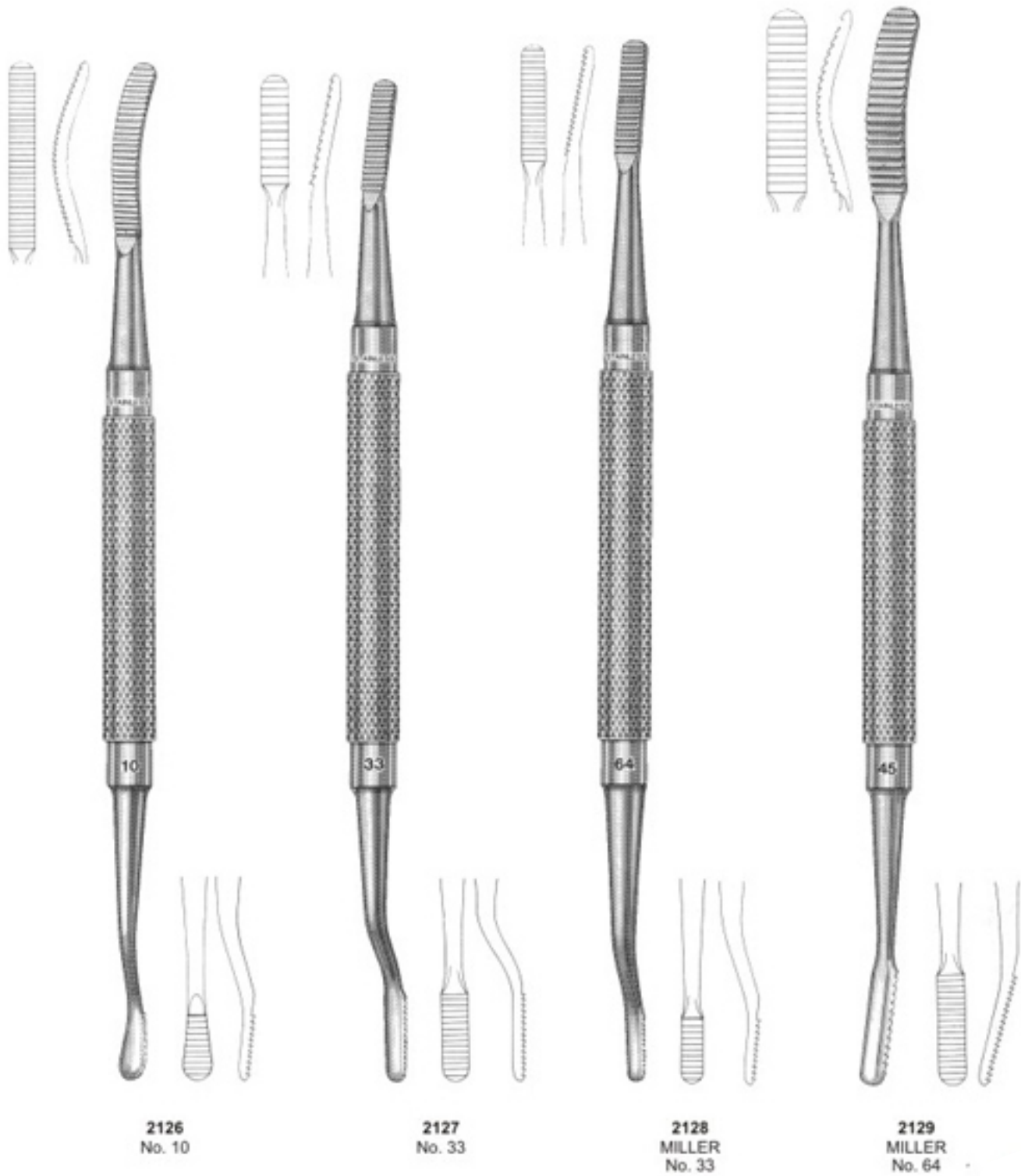

Bone Files



2130
HOWARD
No. 12



2131
HOWARD
No. 12A



2132
HOWARD
No. 12CA

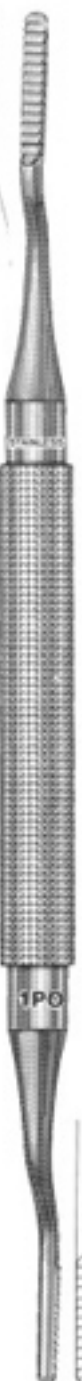

2133
POLOKOFF
No. 1

Bone Chisels

GARDNER



2134
GARDNER
No. 1

2135
GARDNER
No. 2

2136
GARDNER
No. 5

2137
GARDNER
No. 5R

WAKEFIELD



2138
WAKEFIELD
No. 1W

2139
WAKEFIELD
No. 2W

Bone Chisels and Gouges

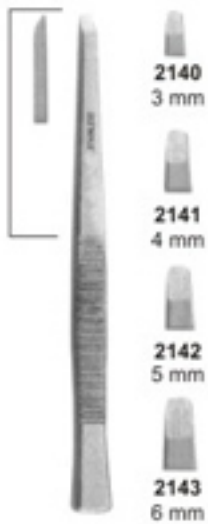

PARTSCH
13,5 cm

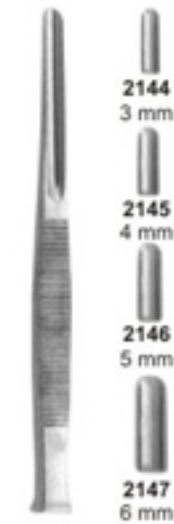

PARTSCH
13,5 cm

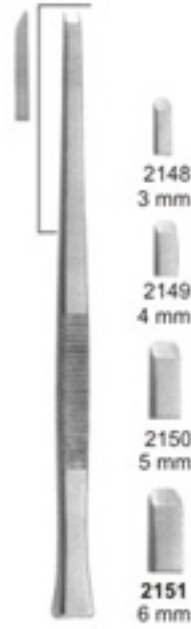

PARTSCH
17 cm

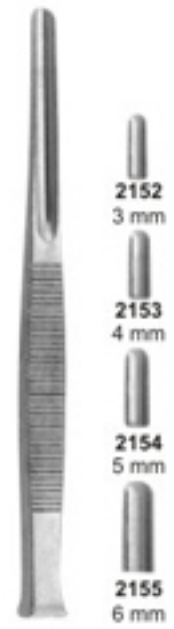
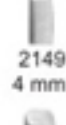

PARTSCH
17 cm



Martelli chirurgici Mallet

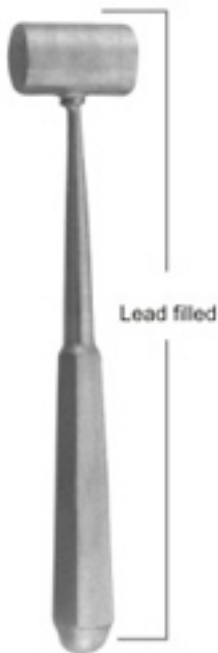

2156
PARTSCH
19 cm



2157
MEAD
19,5 cm

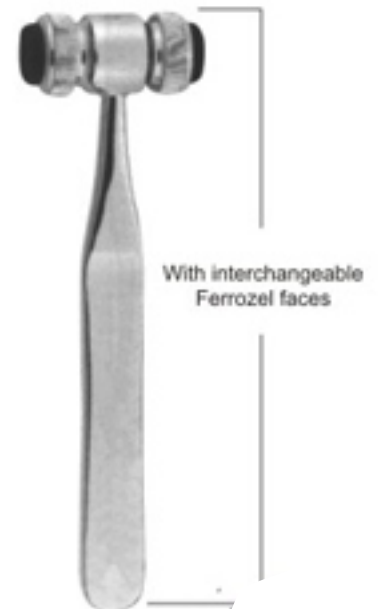

2158
MEAD
17 cm

Crown Removers



Crown Spreader, Crown Remove.
Special instrument for crown spreading
after separating, simple and safe
operation.

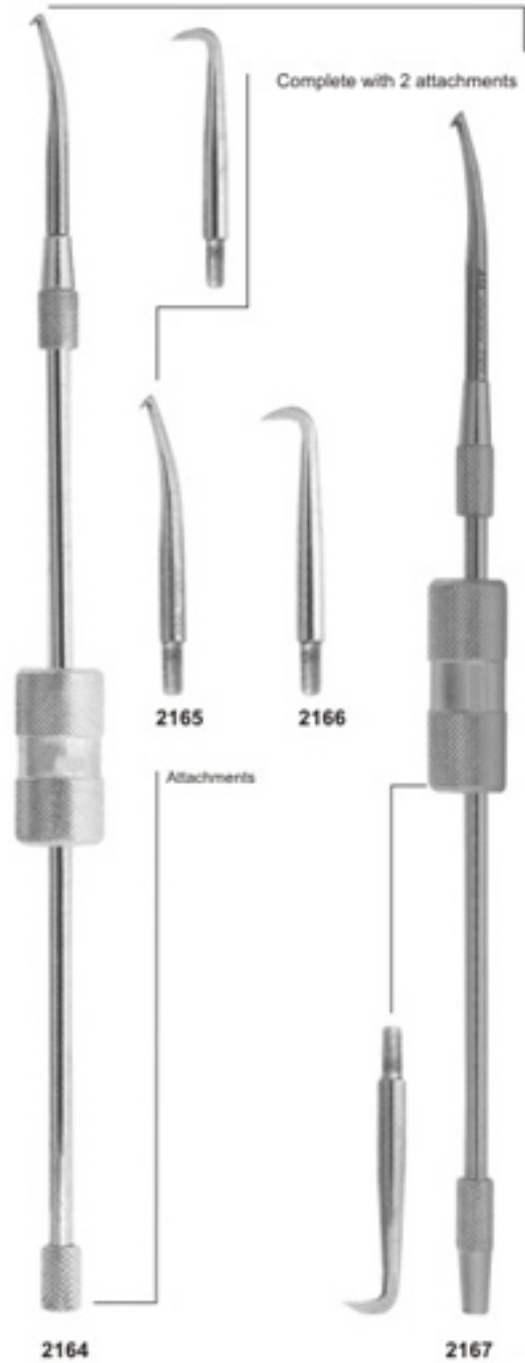

Crown Instruments

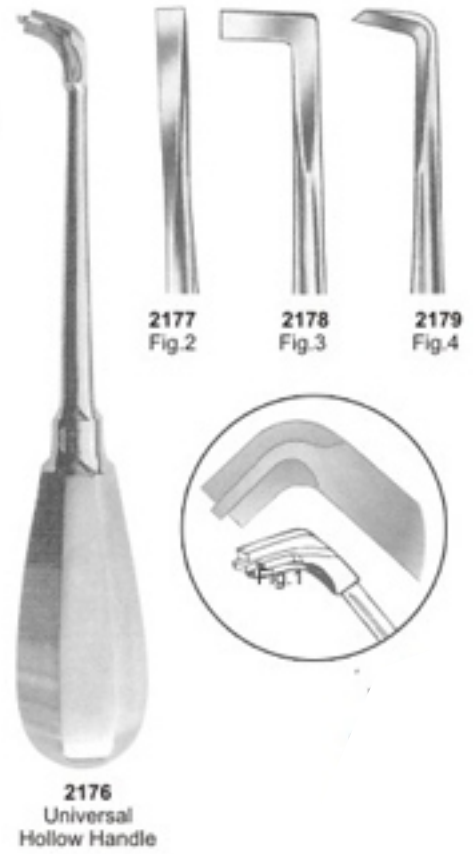
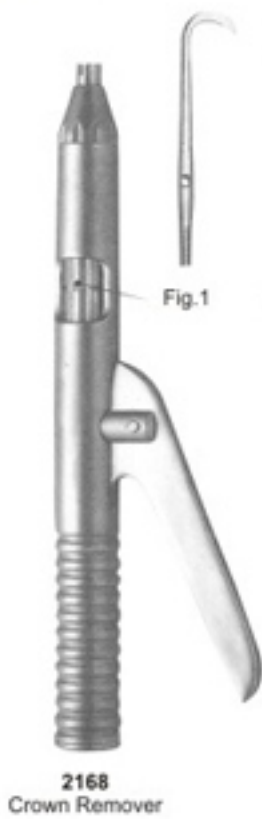

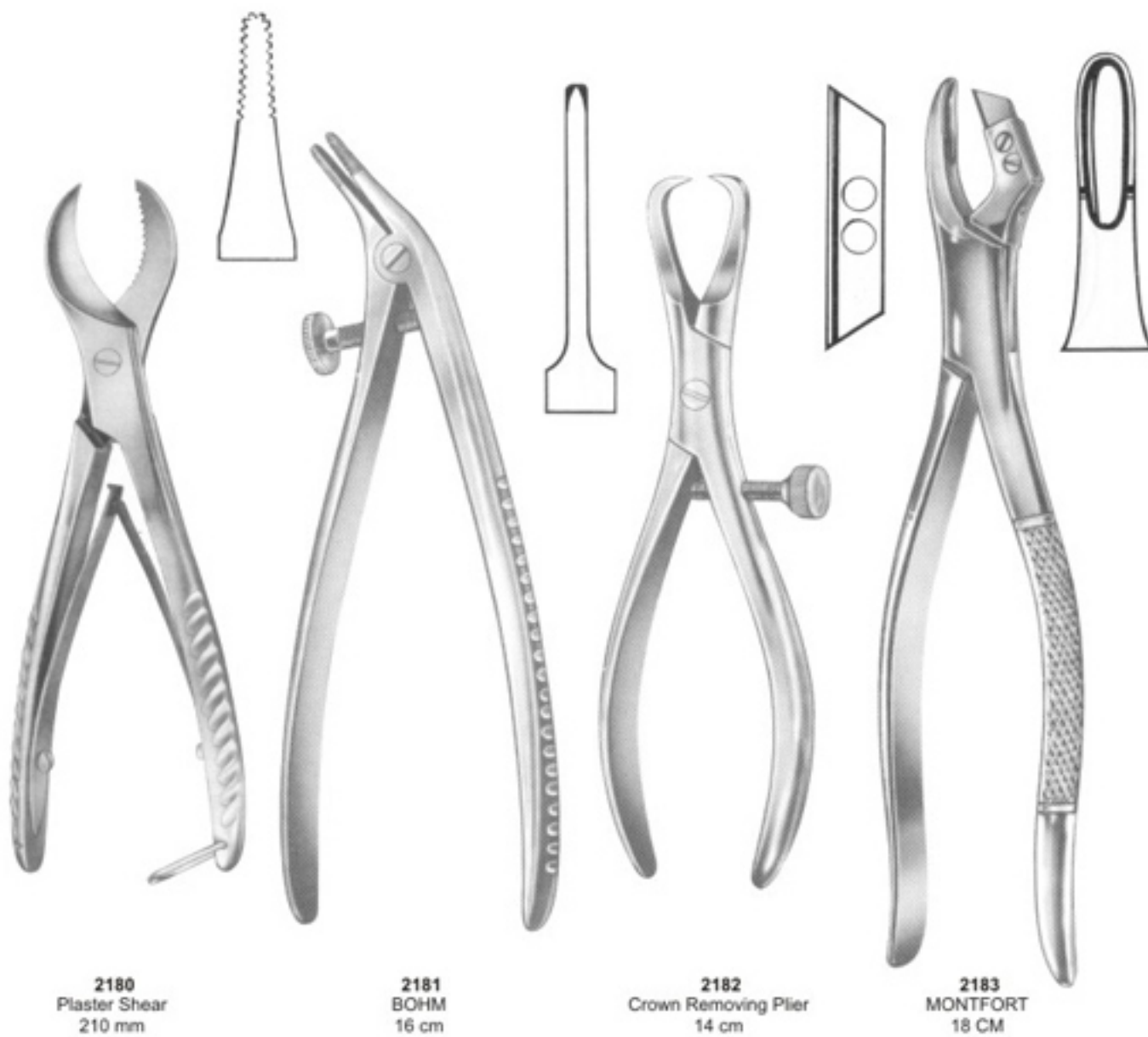

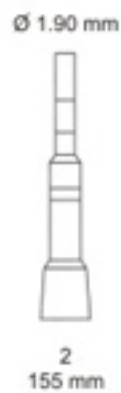
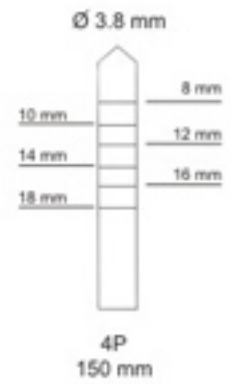



2186
Fig. 1B
165 mm

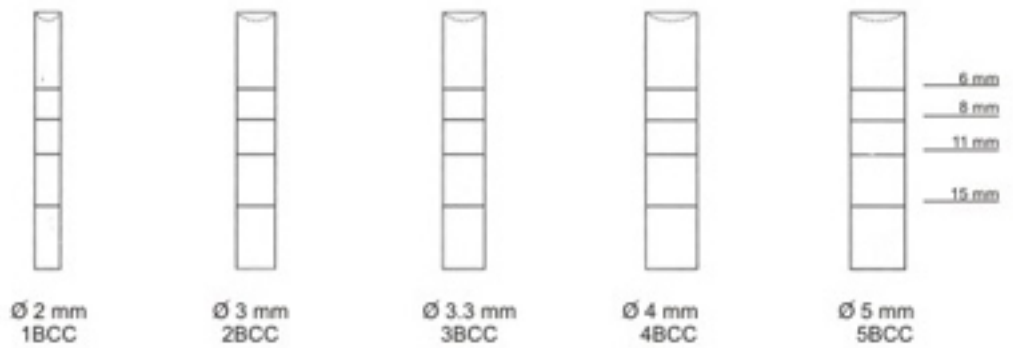
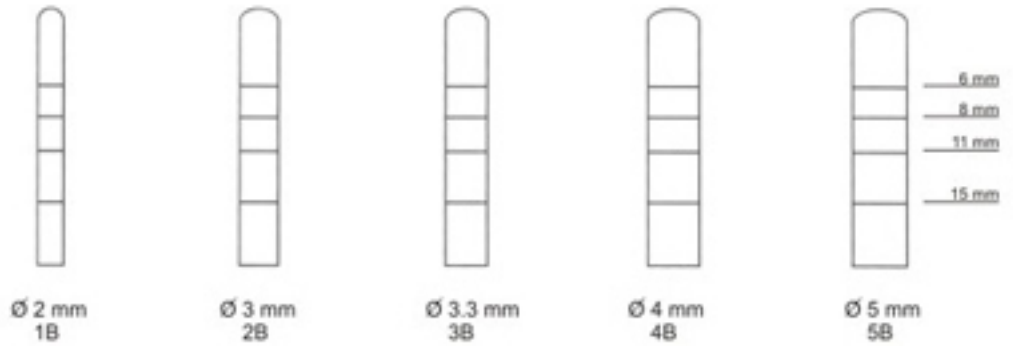

2187
Fig. 1
155 mm

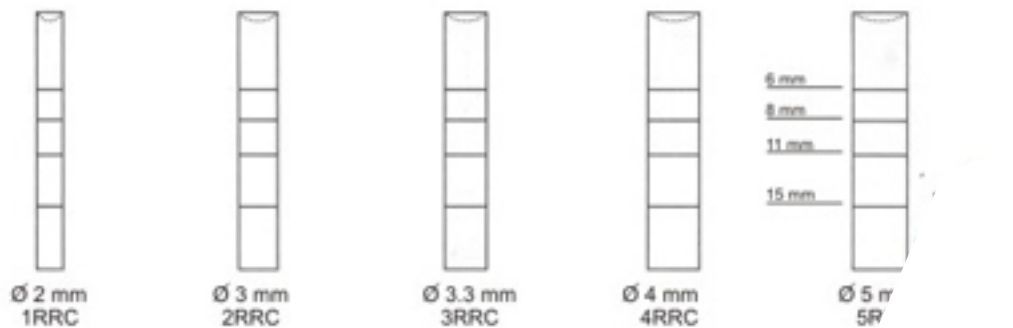
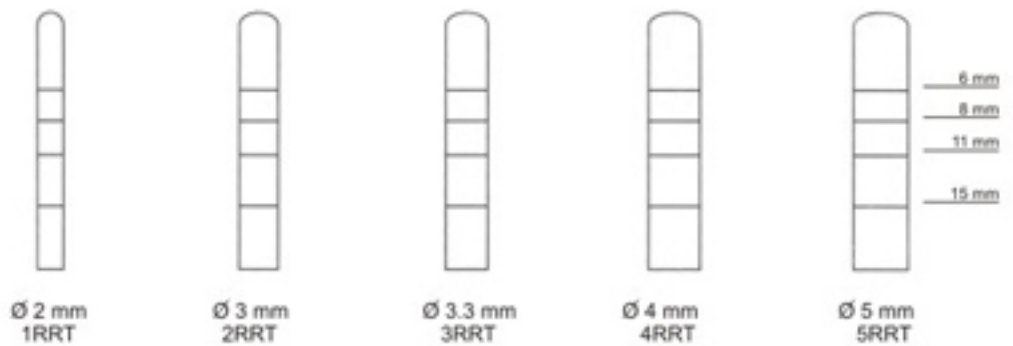

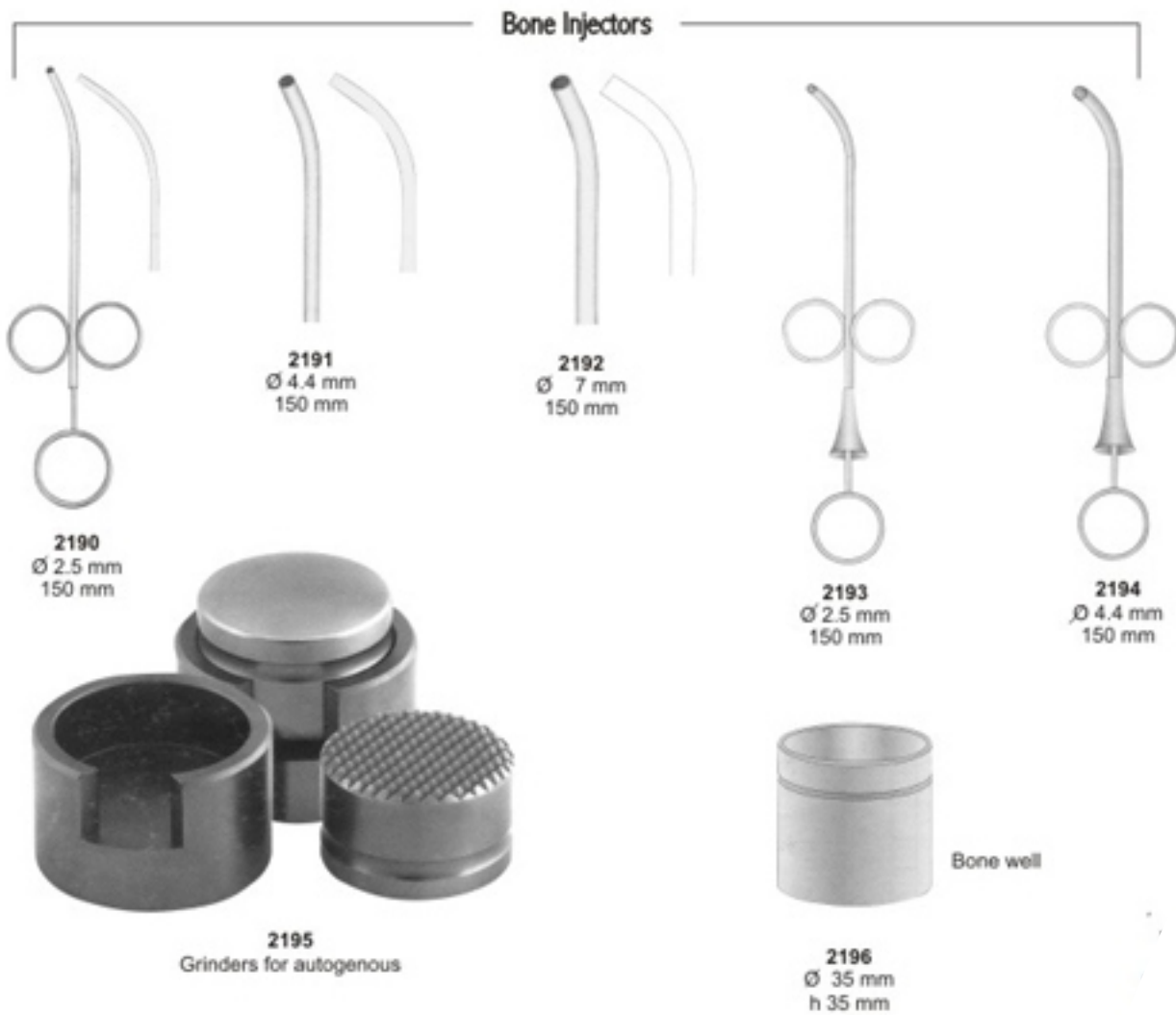
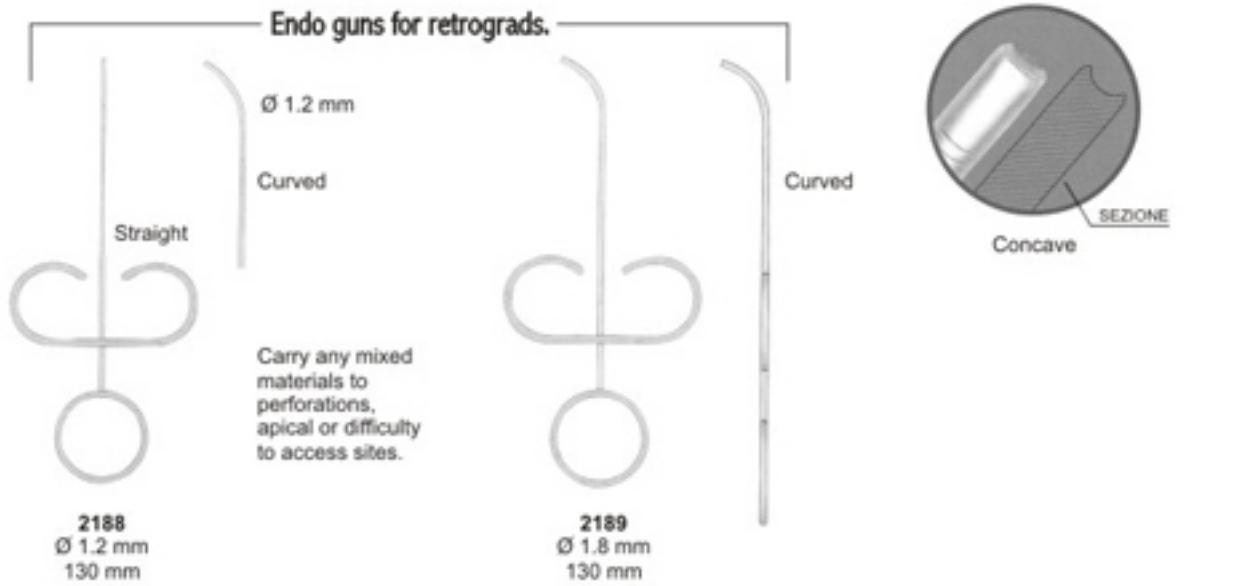



2197
Fig. 1
170 mm

2198
Fig. 2
175 mm

2199
Fig. 3
170 mm

2200
LUCAS
Fig. 88
170 mm

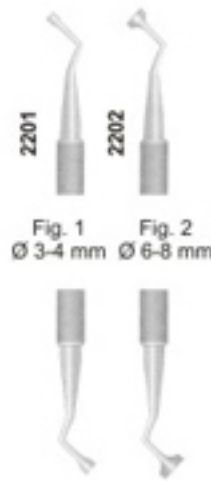

2201 Fig. 1
Ø 3-4 mm

2202 Fig. 2
Ø 6-8 mm

Bone Compactors.

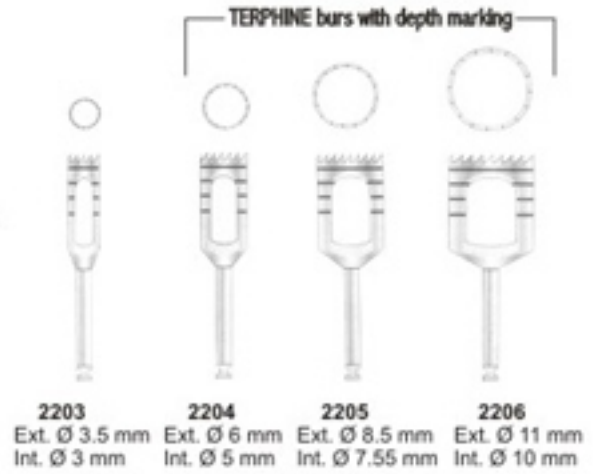

2203
Ext. Ø 3.5 mm
Int. Ø 3 mm

2204
Ext. Ø 6 mm
Int. Ø 5 mm

2205
Ext. Ø 8.5 mm
Int. Ø 7.55 mm

2206
Ext. Ø 11 mm
Int. Ø 10 mm

Sinus lift instruments



2207
Fig.1

2208
Fig.2

2209
Fig.3

2210
Fig.4

2211
Fig.5

2212
Fig.6

2213
Fig.7

2214
Fig.8

22 F'



2216
BOLEY Gauge



2217
ZURICHER
130 mm



2218
VERNIER
12 cm



2219
VERNIER



2220
Height Gauge
Wick Type



2221
LWANSON
Crown Gauge



2222
CASTROVIEJO'S
Sclerer Marker



2223
Spring Bow Divider
6" Radius



2224
ALBEE

Section - 05

- * Measuring Instruments
- * Amalgam Guns & Carriers
- * Retainers
- * Rubber Dam Instruments
- * Syringes * Tweezers
- * Sterilizing & Lab. Instruments



Amalgam Guns & Carriers

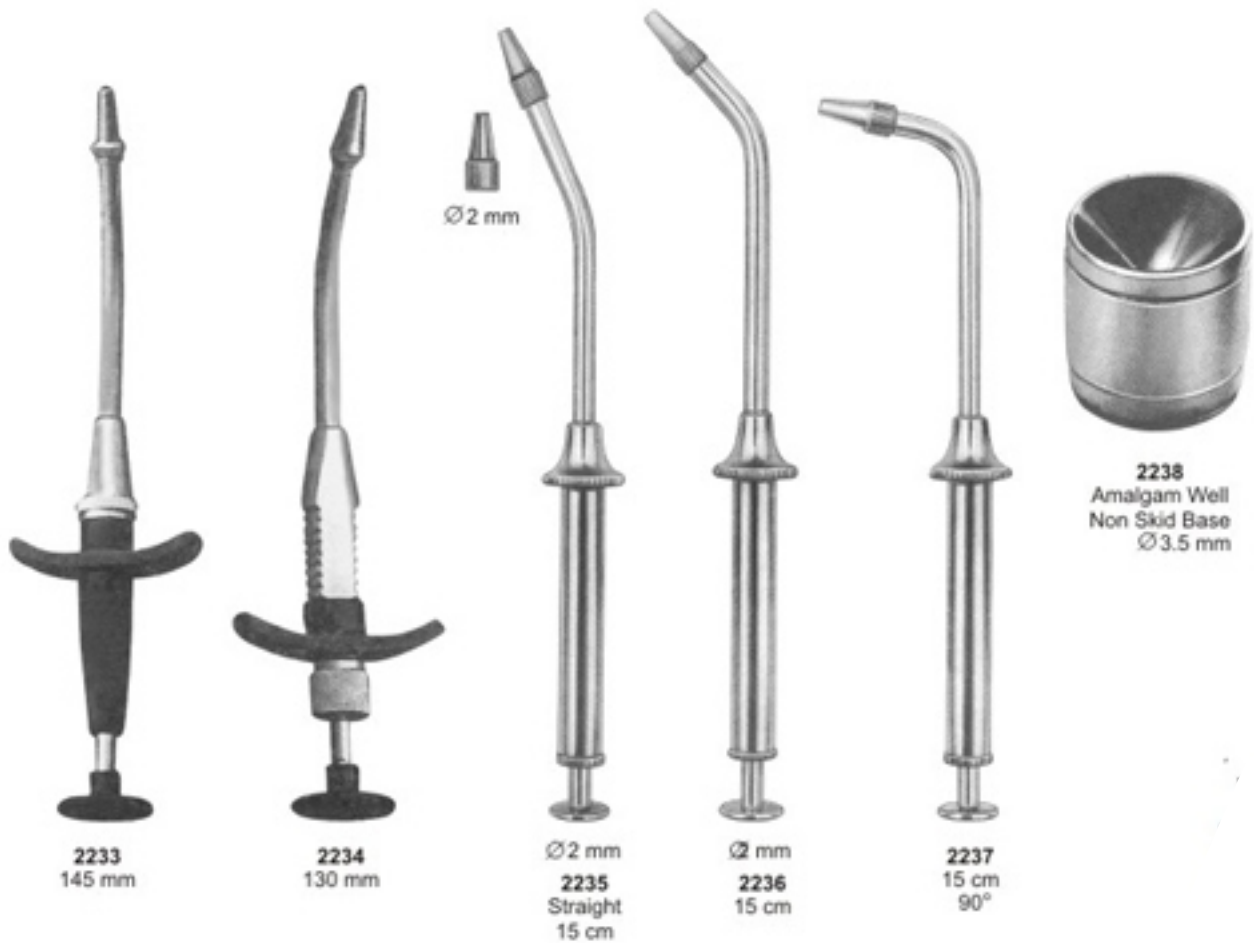
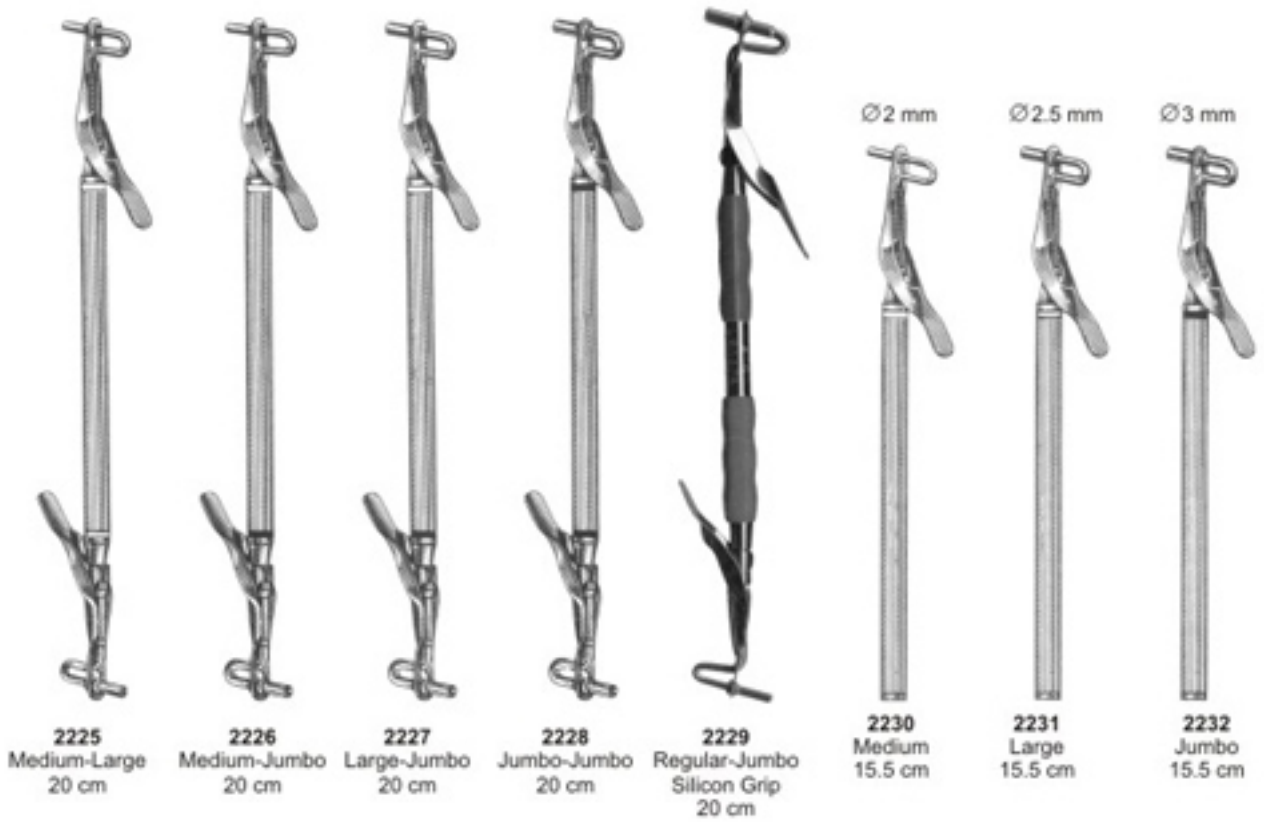

Retainers, Bands, Strip Holder Clips, Napkin Holders



Retainers



2239
No. 1

2240
No. 8

2241
No. 9

"Tofflemire" Type Retainers

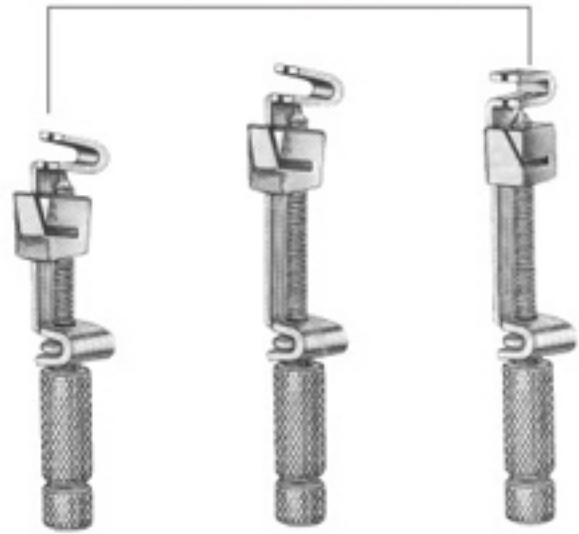

2242
JUNIOR-CA

2243
SENIOR-CA

2244
UNIVERSAL

Tofflemire Bands

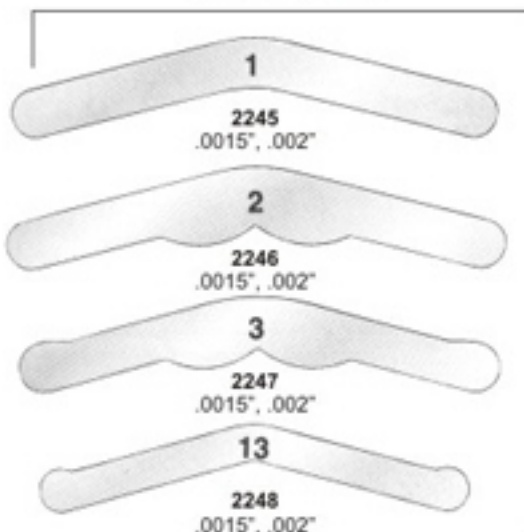

1
2245
.0015", .002"

2
2246
.0015", .002"

3
2247
.0015", .002"

13
2248
.0015", .002"

Napkin Holders



2249
BALL CHAIN

2250
NON-CHILL
Clear Plastic

Strip Holders



2251
Strip Holder Clip
90°

2252
Strip Holder
45°

Rubber Dam Instruments



2253
IRORY
Light weight, 170 mm



2254
BREWER
175 mm



2255
BREWER
175 mm



2256
WHITE
175 mm



2257
IVORY
170 mm



2258
AINSWORTH
Rubber Dam Punch
170 mm



2259
AINSWORTH
Rubber Dam Punch
170 mm



2260
AINSWORTH
Rubber Dam Punch
170 mm

Articulating Paper Forceps



2264
MILLER
Articulating
Forceps
15 cm



2265
MILLER
Articulating
Forceps
15 cm



2261
"IV" Type
Rubber Dam Punch
160 mm



2262
Plastic Rubber Dam
Frame 242

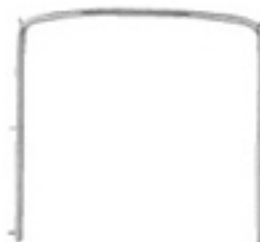

2263
Rubber Dam Holder
Stainless Steel Pins

Rubber Dam Clamps

LOWER MOLARS



2266
76D-W3

2267
76D-3



2272
76D-7A

2273
76D-7



2278
76D-12A

2279
76D-13A



2284
76D-26

2285
76D-28



2288
76D-W8A

2289
76D-8A



2290
76D-10

2291
76D-11



2294
76D-24

2295
76D-25

UPPER MOLARS



2268
76D-4

2269
76D-5



2274
76D-8

2275
76D-26N



2280
76D-30

2281
76D-31



2286
76D-201

2287
205

MOLARS



2292
76D-14

2293
76D-118



2296
76D-27

2297
76D-56



2298
76D-14A

PREMOLARS



2270
76D-0

2271
76D-1



2276
76D-2A

2277
76D-2



2282
76D-27N

2283
76D-29

ANTERIOR



2299
76D-00

2300
76D-1A



2301
76D-9

2302
76D-212

Aspirating Syringes

4969/CO



4969/F



4969/CV



2303
ml 1,8
EU



2304
ml 1,8
EU/AM



2305
ml 1,8
EU/AM



2306
Fig. 1
ml 1,8
EU



2307
Fig. 1
ml 1,8
EU



2308
SS INOX
All inox & autoclavable
black plastic handle
passive automatic
aspiration.



2309
Fig. 1
ml 1,8
EU/Am



2310
Fig. 1
ml 1,8
EU/Am



2311
Fig. 1
ml 1,8
EU/Am



2317
ml 1
EU



2313
Water Syringe
complete with
1 cannula (Lure-Lock)



2314
Water Syringe
complete with
1 cannula (Lure-Lock)



2315
Metal Water Syringe
self-filling, with 1
cannula (Lure-Lock)



2316
Sparrel Barrel with
plunger suitable for
syringes



2317
Cannula, only, with
Luer-Lock connector
suitable for syringes



2318
Articulating Barrel Syringe



2319
ml 1,8



2320
ml 1,8



2323
Fig. 1
ml 1,8 EU



25°Angular

2321
Fig. 1
ml 1,8



2322
Fig. 1
ml 1,8 EU

Dental Tweezers

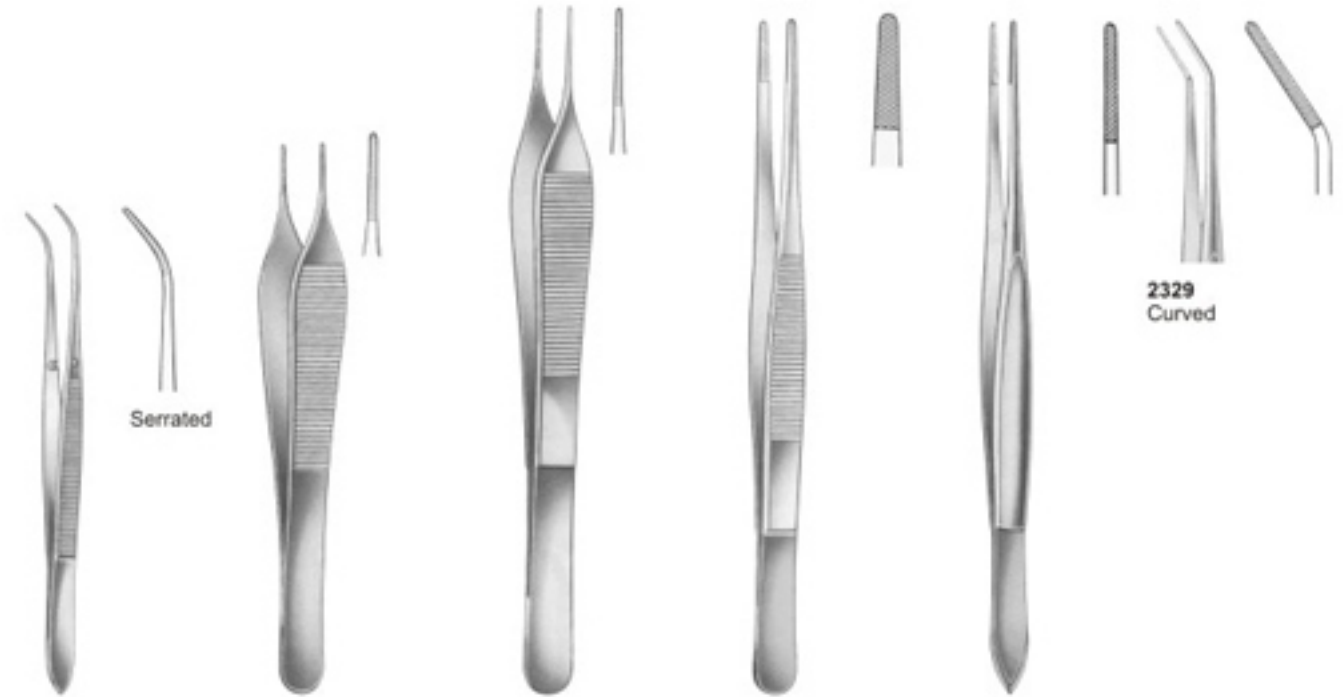

2324
PERRY
13 cm

2325
ADSON
12 cm

2326
MICRO ADSON
15 cm

2327
STANDARD
14, 18, 25 cm

2328
CUSHING
18 cm

2329
Curved



2330
SELECT
15, 18, 20 cm

2331

2332
MCINDOE
15 cm

2333
GILLIES
15 cm

2334
WAUGH
15, 20 cm

2335
KOP
15, 7

Dental Tweezers



2336
COLLEGE
15 cm



smooth



2337
COLLEGE
15 cm



serrated



2338
COLLEGE
15 cm



smooth



2339
COLLEGE
15 cm



serrated



2340
COLLEGE
15 cm



smooth



2341
COLLEGE
15 cm



serrated



2342
COLLEGE
15 cm



smooth



2343
COLLEGE
15 cm



serrated

Dental Tweezers



2344
MERIAM
16 cm



smooth



2345
MERIAM
16 cm



serrated



2346
MERIAM
16 cm



smooth



2347
MERIAM
16 cm1



serrated



2348
MERIAM
16 cm



smooth



2349
MERIAM
16 cm



serrated



2350
MERIAM
16 cm



smooth



2351
MERIAM
16 cm



serrated

Dental Tweezers

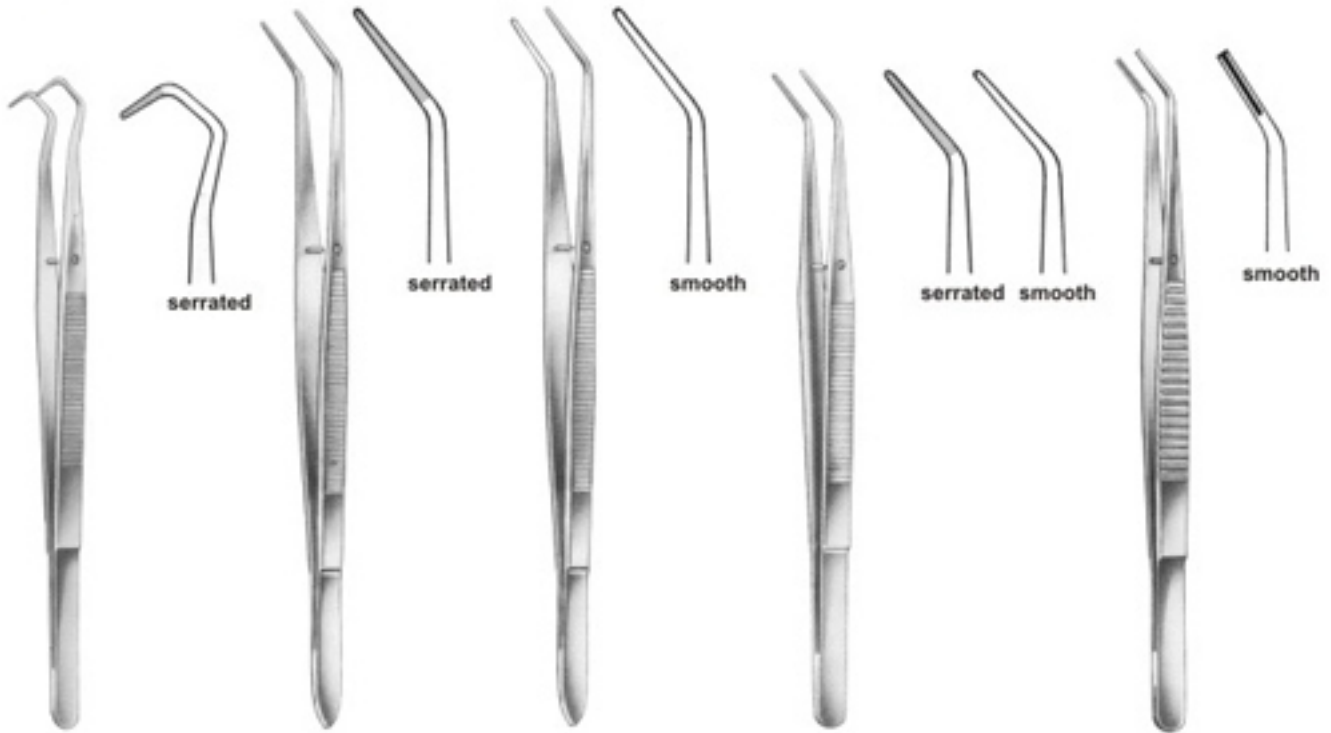

2352
COLLEGE
14.5 cm, 5^{3/4}"

2353
FLAGG
16 cm, 6^{1/4}"

2354
FLAGG
16 cm, 6^{1/4}"

2355
LANDGRAF
15 cm, 6"

2356
15,5 cm, 6^{1/8}"

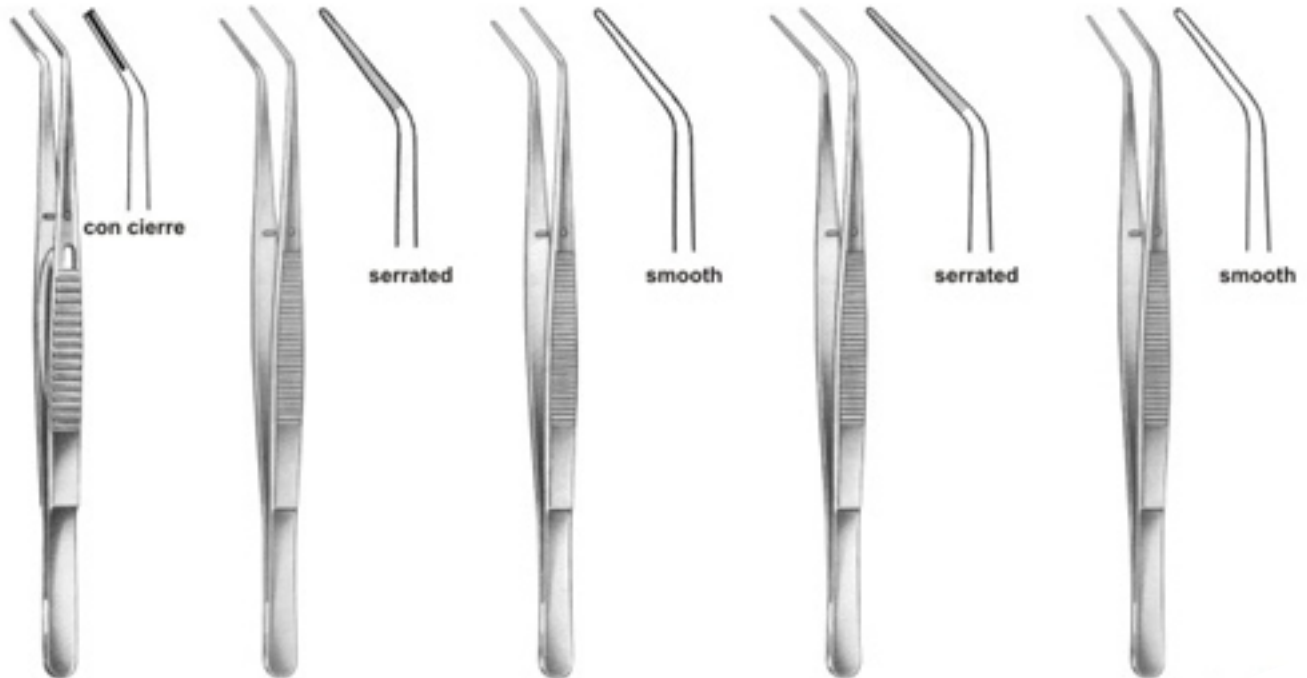

2357
15.5 cm, 6^{1/8}"

2358
LONDON-COLLEGE
15 cm, 6"

2359
LONDON-COLLEGE
15 cm, 6"

2360
LONDON-COLLEGE
15 cm, 6"

2361
LONDON-COLLF
15 cm, 6"

Dental Tweezers



2362
LONDON-COLLEGE
15 cm, 6"



2363
LONDON-COLLEGE
15 cm, 6"



2364
MERIAM
16 cm, 6 1/4"



2365
ALLEN
18 cm, 7 1/8"



2366
ALBRECHT
16 cm, 6 1/4"



2367
ALBRECHT
16 cm, 6 1/4"



2368
16 cm, 6 1/4"



2369
16 cm, 6 1/4"



2370
16 cm, 6 1/4"





2371
DAVIS
6"



2372
Grasping Forceps
6 1/4"



2373
Mesh Bur & Diamond Holder
Large, 2 1/8" Diameter



2374
Soldering Tweezers
6 1/4"



2375
Narrow Fine
4 3/4"



2376
Super Fine
4 3/8"



2377
Fine Curved
4 1/2"



2378
Bonding Bracket
Holder
136 mm



2379
Bonding Bracket
Holder
135 mm



2380
Bonding Bracket
Holder
135 mm



2381
Bonding
Bracket
Holder
135 mm

Section - 06

- ★ Endodontic Forceps
- ★ Tissue Forceps
- ★ Retractors
- ★ Mouth Gags



Endodontic Forceps



2382
Endo Forceps
4 3/4"



2383
PEETS Forceps
4 3/4", Useful For
Removing Broken
Instruments

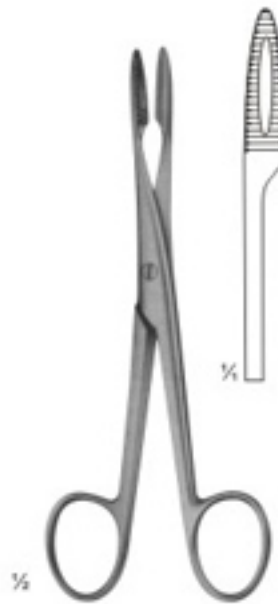

2384
Without Ratchet
145 mm

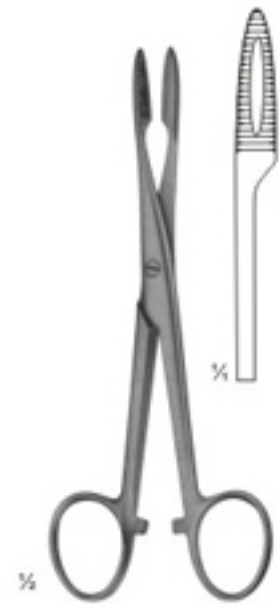

2385
With Ratchet
145 mm



2386
CRILE
140 mm

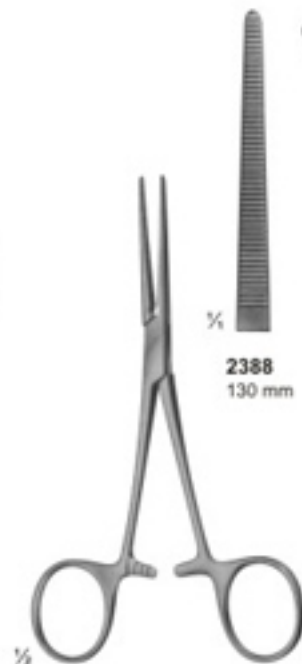

2387
PEAN
Slender type



2388
130 mm

2389
140 mm

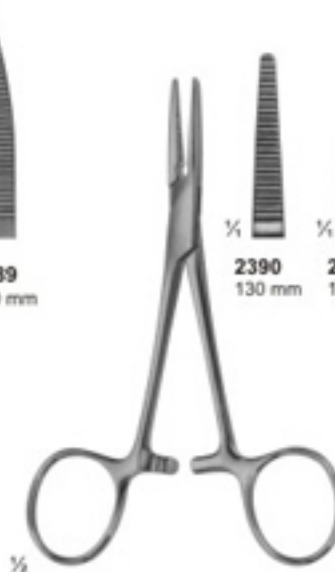

2390
SPENCER-WELLS

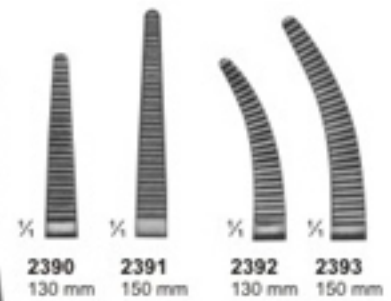

2390
130 mm

2391
150 mm

2392
130 mm

2393
150 mm

Tissue Forceps



2394
BABY-ALLIS
5", Straight
4x5 teeth extra delicate



2395
ALLIS
6", Straight
4x5 teeth extra delicate



2396
ALLIS
6", Straight
4x5 teeth extra delicate



2397
1x2 teeth
6"



2398
SEMKIN
6", Straight,
1x2 teeth



2399
ADSON
4 3/4"
1x2 teeth



2400
BROWN-ADSON
4 3/4"
7x7 teeth



2401
BROWN
6"
8x8 teeth



2402
RUSSIAN
6"
8x8 teeth



2403
Extra-Delicate
Straight
1x2

Hemostatic Forceps, Towel Clamps, Napkin Holders



2404
HALSTED-MOSQUITO
Straight, Curved, 5"



2405
HALSTED-MOSQUITO
Straight, Curved, 5"
1x2 teeth



2406
HALSTED-MOSQUITO
Jaws 45 Angled on Flat, 5"
Extra Delicate



2407
KELLY
5 1/2", Straight



2408
JONES
3 1/2"



2409
BACKHAUS
3 1/2"



2410
BACKHAUS
5 1/4"



2411
LORNA
Non Perforated,
3 1/2"



2412
WEITLANER
Sharp
130 mm

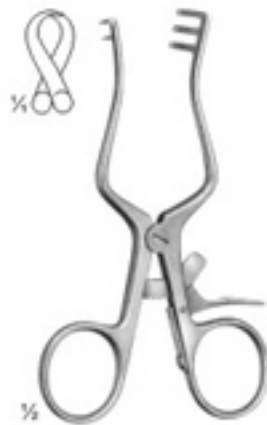

2413
WEITLANER
Sharp
110 mm

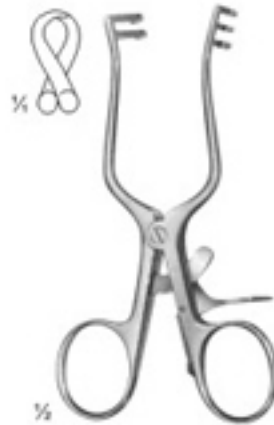

2414
WEITLANER
Semi-Sharp
110 mm



2416
ANDREWS
Tongue Depressor,
Serrated Blade 21 mm
wide

2415
WIEDER
Tongue Depressor,
Small Blade 28 mm Wide
Serrated



2417
MOLT
Pediatric



2418
MOLT
Child



2419
MOLT
Adult



2420
DENHAR

Lip & Cheek Retractors



2421
140 mm



2422
BRUENINGS
190 mm



2423



2424



2425



2426



2427



2428



2429

Lip & Cheek Retractor



2430
LANGENBECK
210 mm



2431
KOCHER-LANGENBECK
215 mm



2432
BUCHS
205 mm



38 x 18 mm



2433
KOCHER
230 mm



2436
MIDDELDORPF



2434
15 x 15 mm
220 mm



2435
20 x 22 mm
215 mm



2437
28 x 28 mm
235 mm



2438
KOCHER
230 mm



2439
COLLIN
150 mm



2440
ROUX
Set
165 mm

Tissue Retractors & Hooks



2441
3 sharp prongs



2442
2 sharp prongs
6"



2443
2 sharp prongs
6"



2444
FOMON
145 mm



2445
ALM
70 mm



2446
SENN
3 sharp prongs
6 3/8"



2447
TOENNIS
Dura Retractor
150mm



2448
JOSEPH
165 mm



2449
GILLIES
180 mm



2450
Fig. 101
Wire Bending



2451
Fig. 118
PEESO
Collar



2452
Fig. 417
Crown Shell

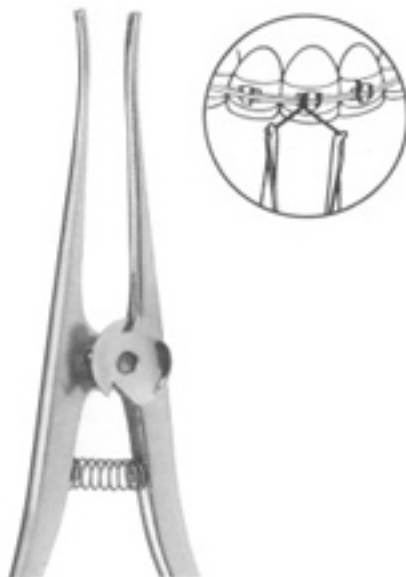

2453
STEINER
150 mm
Ligature Pliers

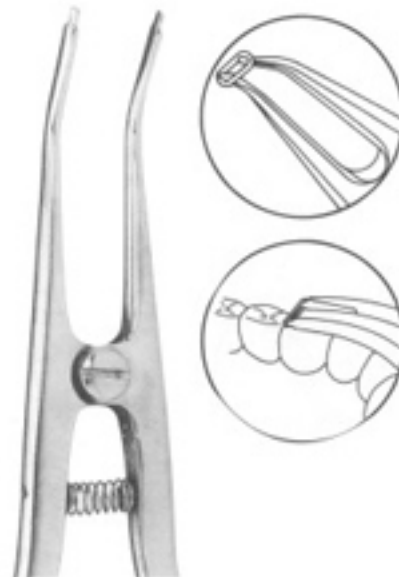

2454
Separating Pliers Elastics
150 mm



2455
121-Lab & Office

Section - 07

- ★ Orthodontic Pliers
- ★ Orthodontic Cutters
- ★ Rongeurs
- ★ Needle Holders



Orthodontic Pliers



2456
How Plier-Titanium Alloy
With special coated beaks



2457
How Plier
Tips are 1/8"(3.2mm)
diameter



2458
How Plier
Tips are 1/8"(3.2mm)
diameter



2459
How Plier-Small
Tips are 3/32"(2.4mm)
diameter



2460
How Plier-Offset
Tips are 1/8"(3.2mm)
diameter



2461
Weingart Utility Plier
-Titanium Alloy
with special coated beaks

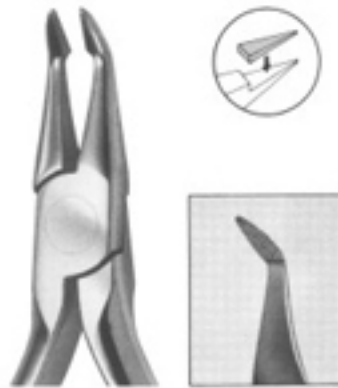

2462
Weingart Utility Plier
New type of the Weingart Utility Plier
designed for a more precise operation.



2463
Weingart Utility Plier



2464
Weingart Utility Plier

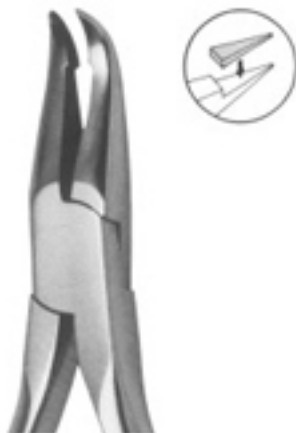

2465
Weingart Utility Plier



2466
Bird Beak Plier With Cutter
Maximum Bending &
Cutting Capacity:
Wires up to .032"



2467
Bird Beak Plier
Maximum Bending Capacity:
Wires up to .032"



2468
Bird Beak Plier
Maximum Bending Capacity:
Wires up to .032"

Orthodontic Pliers



2471
TWEED (Fig. 98)
13 cm, 5 1/8"
Tweed Loop Omega Pliers.



2469
TWEED - (Fig. 90)
14 cm, 5 1/2"



2470
O'BRIEN - (Fig. 97)
14 cm, 5 1/2"



2472
TWEED (Fig. 96)
14 cm, 5 1/2"



2473
TWEED (Fig. 95)
13.5 cm, 5 1/4"



2474
SCHWARZ (Fig. 29)
12.5 cm, 5"



2475
NANCE (Fig. 80)
13 cm, 5 1/8"



2476
YOUNG (Fig. 55)
13 cm, 5 1/8"



2477
SCHWARZ (Fig. 30)
13 cm, 5 1/8"



2478
Optical Plier (Fig. 53)
14 cm, 5 1/2"

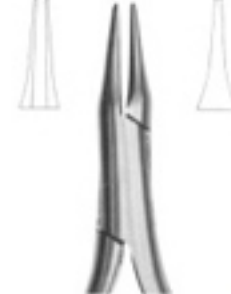

2479
Schwarz (Fig. 79)
13.5 cm, 5 1/4"

Orthodontic Pliers



2480
NANCE (Fig. 56)
12.5 cm, 5"
Wire bending Pliers



2487
Fig. 70
14 cm, 5 1/2"
Wire Contouring Plier



2481
JOHNSON (Fig. 59)
13.5 cm, 5 1/4"
Contouring Plier.



2483
De La Rosa (Fig. 34)
12.5 cm, 5"
Contouring Plier, Non-Grooved



2482
REYNOLDS (Fig. 61)
13 cm, 5 1/8"
Contouring Plier.



2484
De La Rosa (Fig. 35)
12.5 cm, 5"
Contouring Plier, Grooved

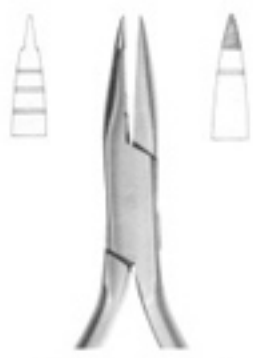

2485
JARABAK (Fig. 20)
14 cm, 5 1/2"
Light Wire Bending Plier



2486
Fig. 58
12.5 cm, 5"
Lingual Arch Bending Plier



2488
Frevort/Tweed (Fig. 51)
12.5 cm, 5"
Tweed Arch Plier/Standard Jaw



2489
ANGLE (Fig. 52)
13 cm, 5 1/8"
Arch Forming Plier

Orthodontic Pliers



2490
Fig. 60
13 cm, 5 1/8"
Wire & Clasp Bending Pliers



2491
Fig. 60
13 cm, 5 1/8"
Wire & Clasp Bending Pliers

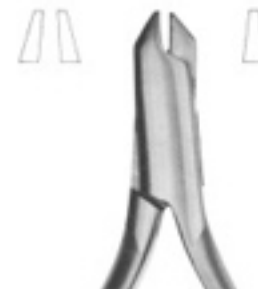

2492
Aderer (Fig. 57)
12 cm, 4 3/4"
Wire & Clasp Bending Pliers



2493
49 e 49 TC
14 cm, 5 1/2"
Band Removing Plier, short pad



2494
50 e 50 TC
14 cm, 5 1/2"
Band Removing Plier, long pad



2495
Fig. 84
14.5 cm, 5 3/4"
Band pinshing & ligature locking plier, serrated



2496
Fig. 72
14 cm, 5 1/2"
Band pinshing & ligature locking plier, serrated



2497
BRACKET (Fig. 82)
13.5 cm, 5 1/4"
Direct Bonding Bracket Remover



2498
BRACKET (Fig. 87)
13.5 cm, 5 1/4"
Direct Bonding Bracket Remov

Orthodontic Pliers



2499
38c, 38TC
13.5 cm, 5 1/4"
Contouring closing loop pliers,
wire bending, cutter.



2500
40c, 40TC
13.5 cm, 5 1/4"
Contouring pliers light wire pliers
grooved with cutter.



2501
Fig. 81
12.5 cm, 5"
Sling clasp & wire bending plier



2502
Fig. 28
14 cm, 5 1/2"
Sling clasp & wire bending plier.



2503
Fig. 21
13 cm, 5 1/8"
Light wires pliers, grooved



2504
46c - 46 TC
ADAMS - N. 139c
12.5 cm, 5"
Bird beak with cutter.



2505
ADAMS, 23, 23TC
12.5 cm, 5"
Sling clasp & wire bending plier.



2506
ADAMS (Fig. 33)
12.5 cm, 5"
For retaining elements.



2507
ADAMS (Fig. 44)
12.5 cm, 5"
Sling clasp & wire bending plier.



2508
Universal Wire Bending
Pliers (ADAMS) 47 TC, N.64
12.5 cm, 5"
Sling clasp & wire bending plier.



2509
86c, 86 TC
Angle Bird Beak - N.138
12.5 cm, 5"
Sling clasp & wire bending plier.

Orthodontic Cutters With T.C.



Ø 1.0 mm
(0.40")

2510
Fig. 18 TC
15 cm, 6"



Ø 1.0 mm
(0.40")

2511
Fig. 92 TC
14 cm, 5 1/8"



Ø 0.4 mm
(0.16")

2512
Fig. 91 TC
13 cm, 5 1/8"



Ø 0.4 mm
(0.16")

2513
Fig. 99 TC
13 cm, 5 1/8"



Ø 0.4 mm
(0.16")

2514
Fig. 94 TC
13 cm, 5 1/8"
Angled at 15° with or
without spring on \
the handles.



2515
Fig. 85 TC
13 cm, 5 1/8"



2516
Fig. 87 TC
13 cm, 5 1/8"



2517
Fig. 85 TC
Angled at 15
13 cm, 5 1/8"



2518
ADAMS 87 TC
Angled at 15
13 cm, 5 1/8"

Orthodontic Distal & Cutters



Pliers for Orthodontic & Prosthetics



2524
UNIVERSAL
150 mm



2525
WALDSACHS
155 mm



2526
ADERER
125 mm



2527
NANCE
125 mm



2528
REYNOLDS
125 mm



2529
HOW
145 mm



2530
HOW
140 mm



2534
FURRER
150 mm



2531
WALDRON
125 mm



2532
ADAMS
125 mm



2533
ANGLE
125 mm



2535
YOUNG
130 mm



2536
NANCE
130 mm

Pliers for Orthodontic & Prosthetics



2537
LANGEBECK
125 mm



2538
LANGEBECK
140 mm



2539
LANGEBECK
130 mm



2540
PEESO
125 mm



2541
GOSLEE
125 mm



2542
FISCHER
140 mm



2543
FISCHER
140 mm



2544
JOHNSON
130 mm



2545
MSY
130 mm



2546
MC KELLOPS
155 mm



2547
ANDRESEN
130 mm



2548
SCHWARZ
130 mm



2549
BLUMENTHAL
6", 30°, Standard



2550
MINI-BLUMENTHAL
6", 45°



2551
MINI-BLUMENTHAL
6", 90°



2552
BLUMENTHAL
7", 30°



2553
MINI-BLUMENTHAL
4 1/2", 30°



2554
MINI-BLUMENTHAL
4 1/2", 45°



2555
CLEVELAND
No. 5-Side Cutting,
6 3/4"

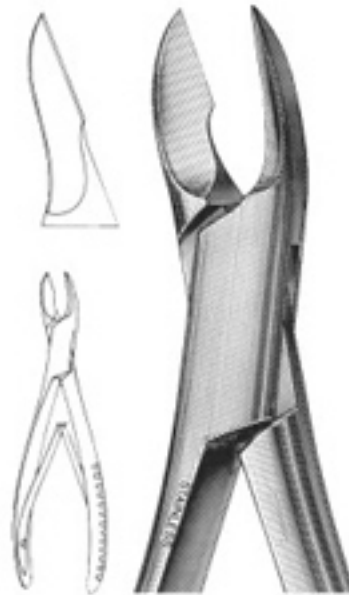

2556
CLEVELAND
No. 5A-Side Cutting,
6 1/2"

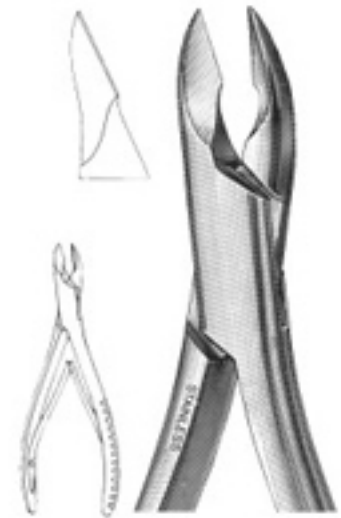

2557
CLEVELAND
No. 5S-Side Cutting,
6"

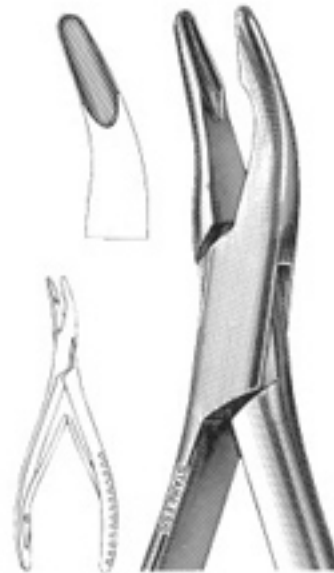

2558
No. 1A-MEAD
6 1/2"

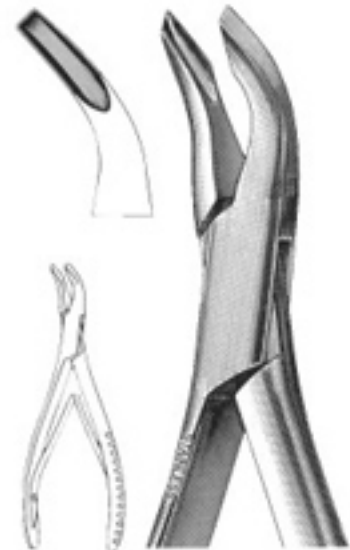

2559
MEAD, Square
No. 2A
Tips, 6 1/2"



2560
FRIEDMAN
5 1/2"

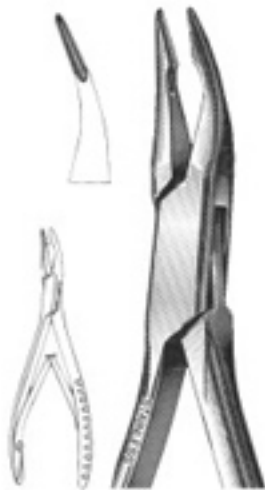

2561
MICRO-FRIEDMAN
5 1/2", 15° Curved Jaws



2562
MICRO-FRIEDMAN
Perio Rongeur, 5 1/2"

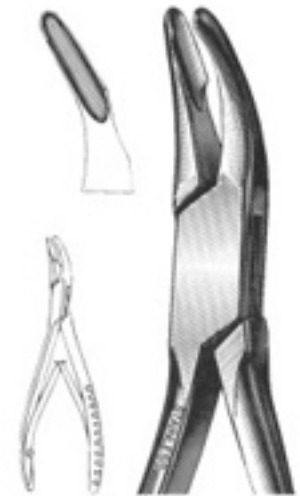

2563
CLEVELAND
No. 4 - 5 1/2"

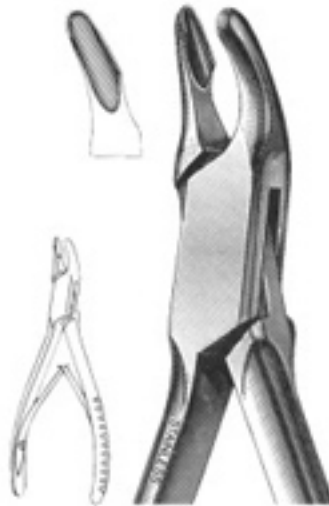

2564
CLEVELAND
No. 4A - 6 1/2"

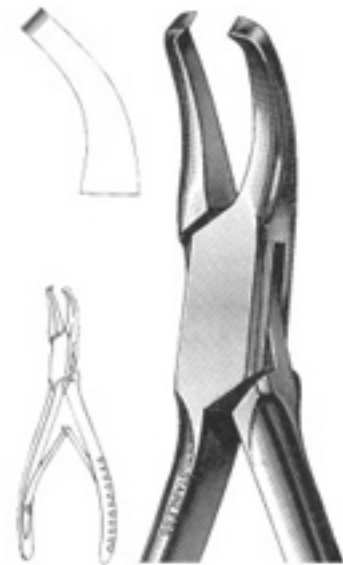

2565
GARDNER
No. 6A, End Cutting
6 1/2"



2566
BEYER
Double Action,
16,18 cm



2567
No. 1
6 1/2"



2568
HARTMAN
5 3/4"
Strong Curve



2569
BANE
Slight Curve
7"

Needle Holders



2570
COLLIER
5", Fenestrated Jaws



2571
DERF
4 3/4"



2572
WEBSTER
Delicate Smooth Jaws
5"



2573
NEIVERT
One Offset Ring
5"



2574
OLSEN-HEGAR
5 1/2"



2575
BAUMGARTNER
5 1/2"



2576
CRILE-WOOD
6"



2577
GARDNER
5"

Needle Holders



2578
MAYO-HEGAR
5"



2579
CRILE
6"



2580
CASTROVIEJO
Smooth Jaws
5 1/2"



2581
BOYNTON
5"



2582
MATHIEU
5 1/2"



2583
STEVENS
6 1/2"

Micro Surgery Set



2584
Micro Scissor
Straight, 155 mm



2585
Micro Scissor
Straight, 150 mm



2586
Micro Scissor
Curved, 150 mm



2587
Micro Scissor
Curved, 155 mm



2588
CASTROVIEJO
T.C.
Straight, 180 mm



2589
Retractor
Fig.3
165 mm



2590
Micro Adson
120 mm



2591
GERALD
Curved,
180 mm



2592
GERALD
Straight,
175 mm



2593
Micro Adson
160 mm



2594
Micro Surgery Set 10 Pieces.

Section - 08

- ★ Scissors
- ★ Impression Trays
- ★ Articulators
- ★ Hollow Wares
- ★ T.C. Instruments



Scissors

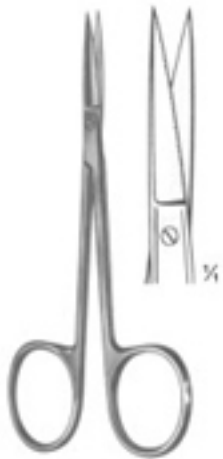

2595
IRIS (Standard)
Straight
11.5 cm, 4 1/2"

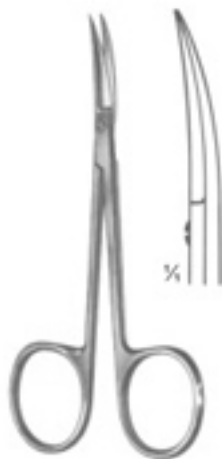

2596
IRIS (Standard)
Curved
11.5 cm, 4 1/2"

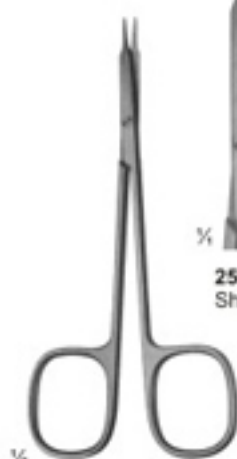

2597
STEVENS
Dissecting Scissors
Size: 115 mm



2598
Sharp



2599
Sharp



2600
Blunt



2601
Blunt



2602
JOSEPH
Size: 150 mm

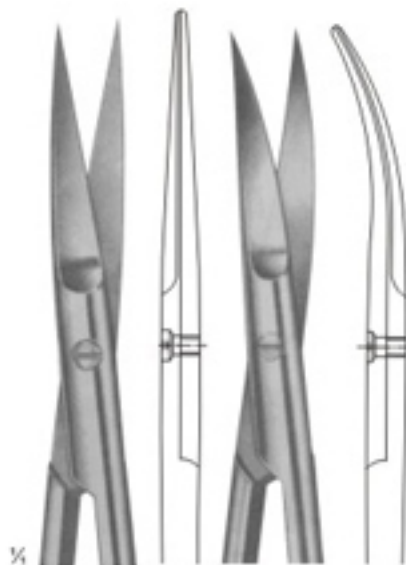

2602

2603

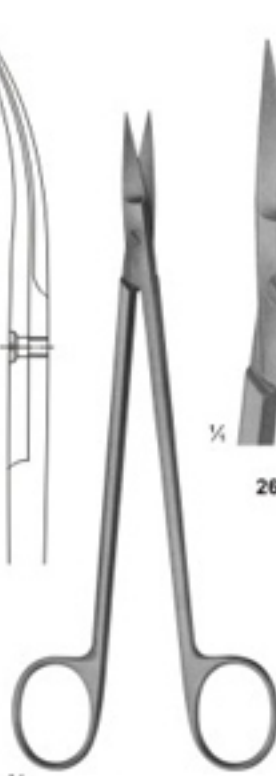

2604
KELLY
Size: 175 mm



2605



2606



2607
QUINBY
Size: 130 mm

Scissors

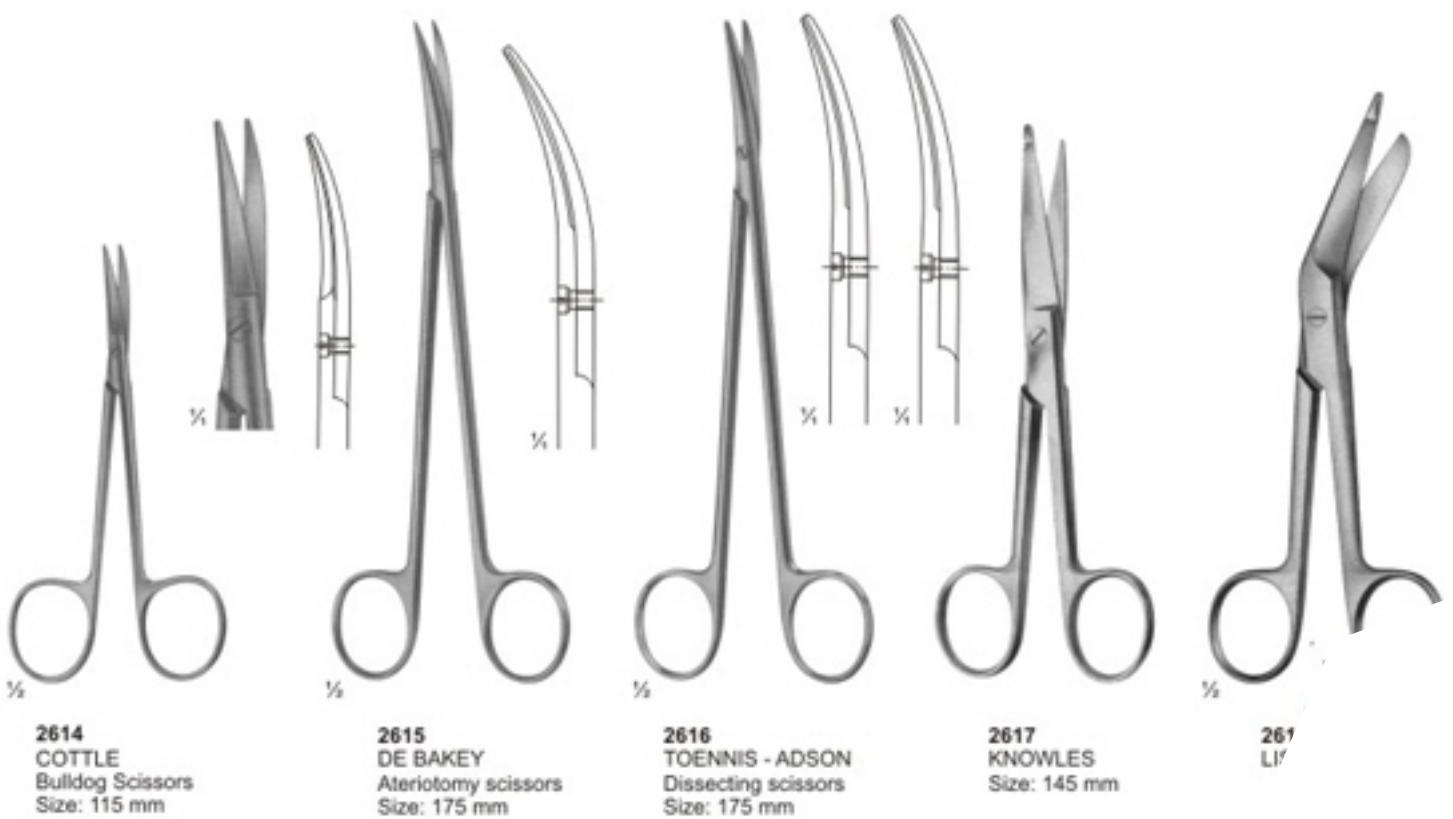
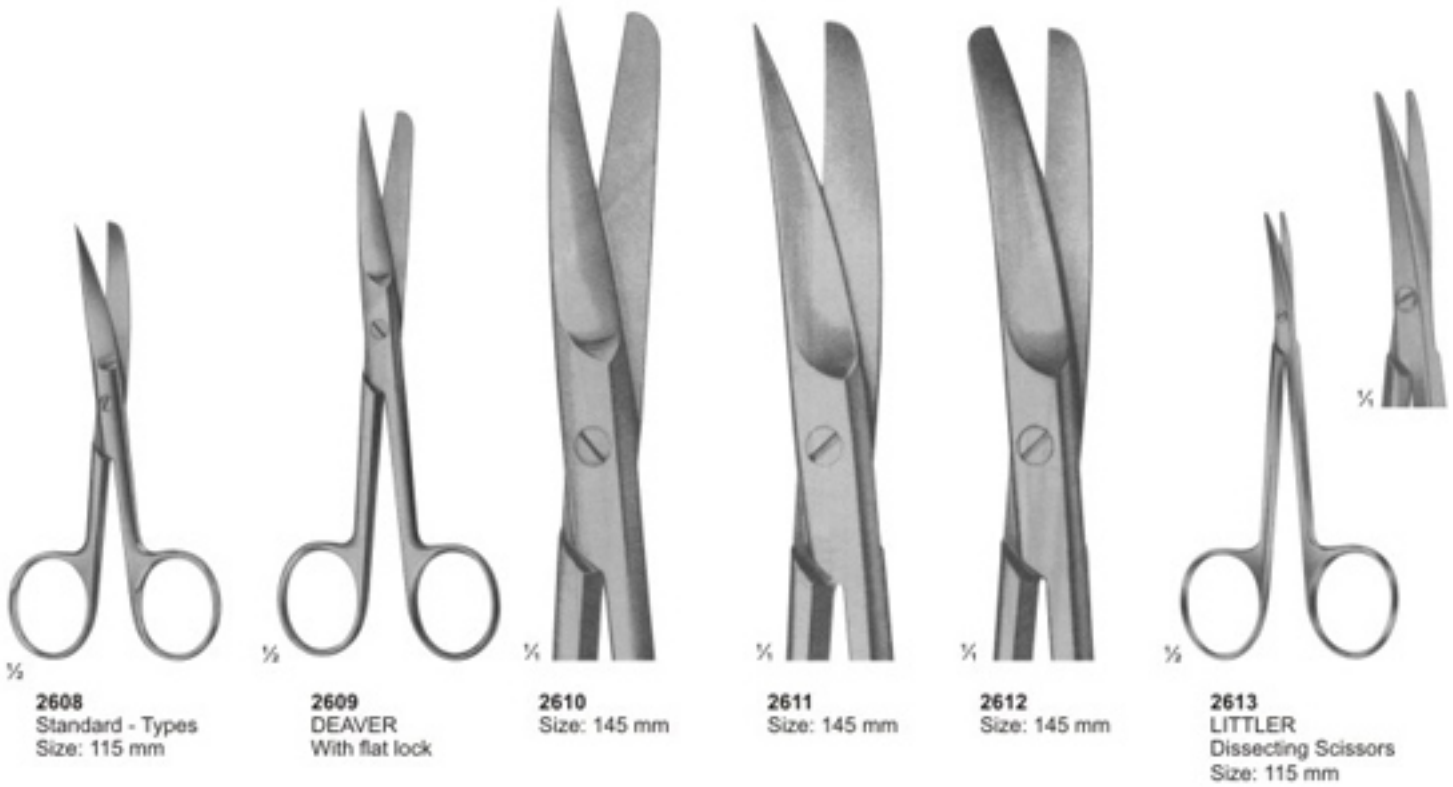

Scissors

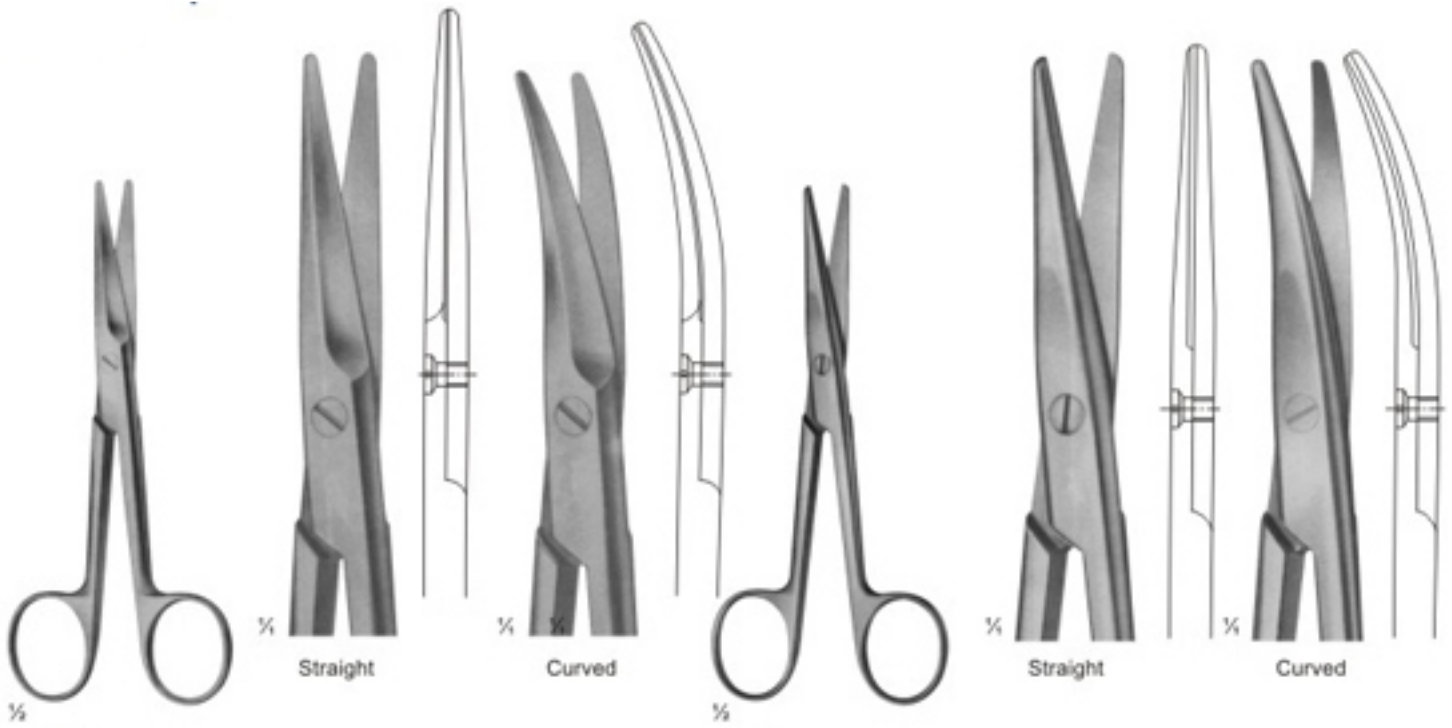

2619
MAYO (straight)
Size: 140 mm

2620
MAYO-STILLE (straight)
Size: 140 mm

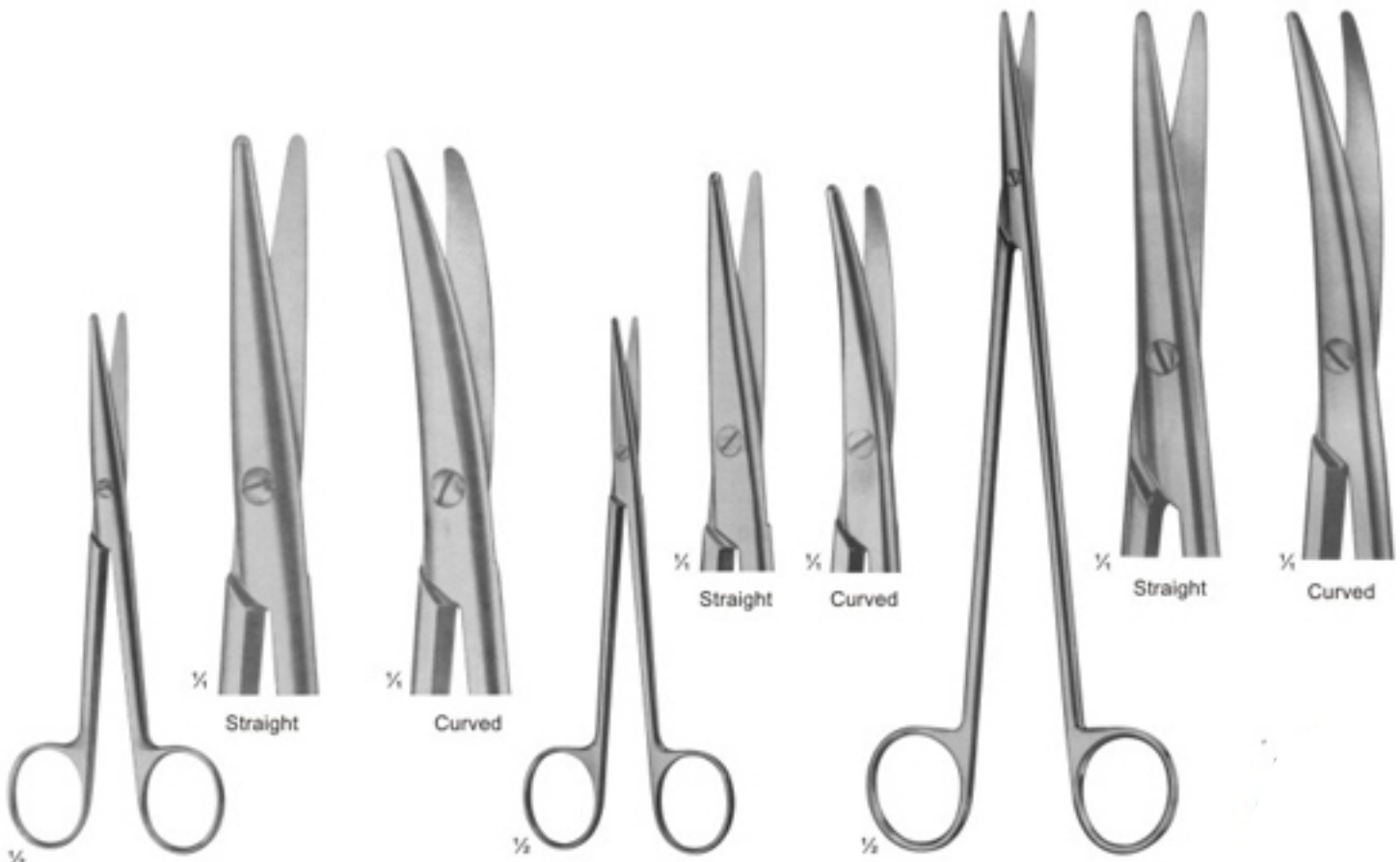

2621
STILLE
Size: 140 mm

2622
METZENBAUM
Size: ---

2623
NELSON-METZENBAUM
Size: ---

Scissors



2624
DE BAKEY
Size: 155 mm



2625
LOCKLIN
Curved Sideways,
1 Toothed Blade
Size: 155 mm



2626
SPENCER
Size: 90 mm

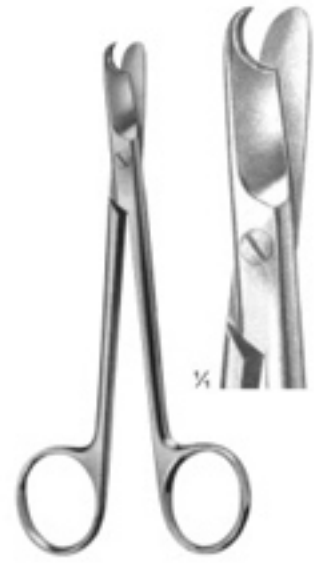

2627
LITTAUER
Size: 135 mm



2628
BEEBE
Size: 110 mm

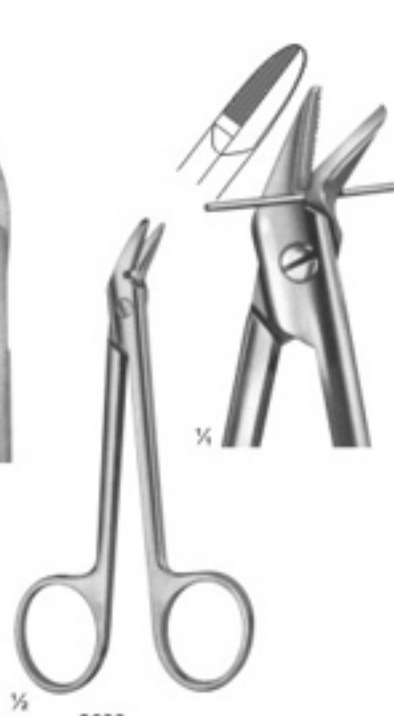
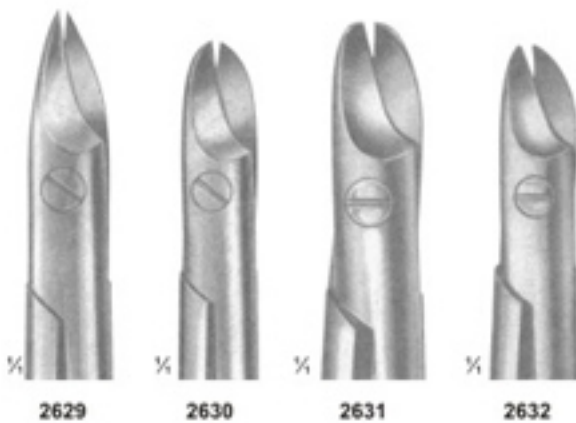

2633
1 Blade Serrated
Size: 120 mm

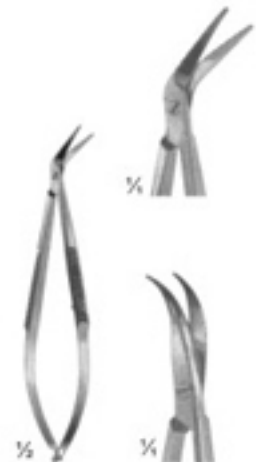

2634
CASTROVIEJO
Size: 90 mm

Impression Trays

Made of 18/8 Stainless Steel, Solid, Set of 10

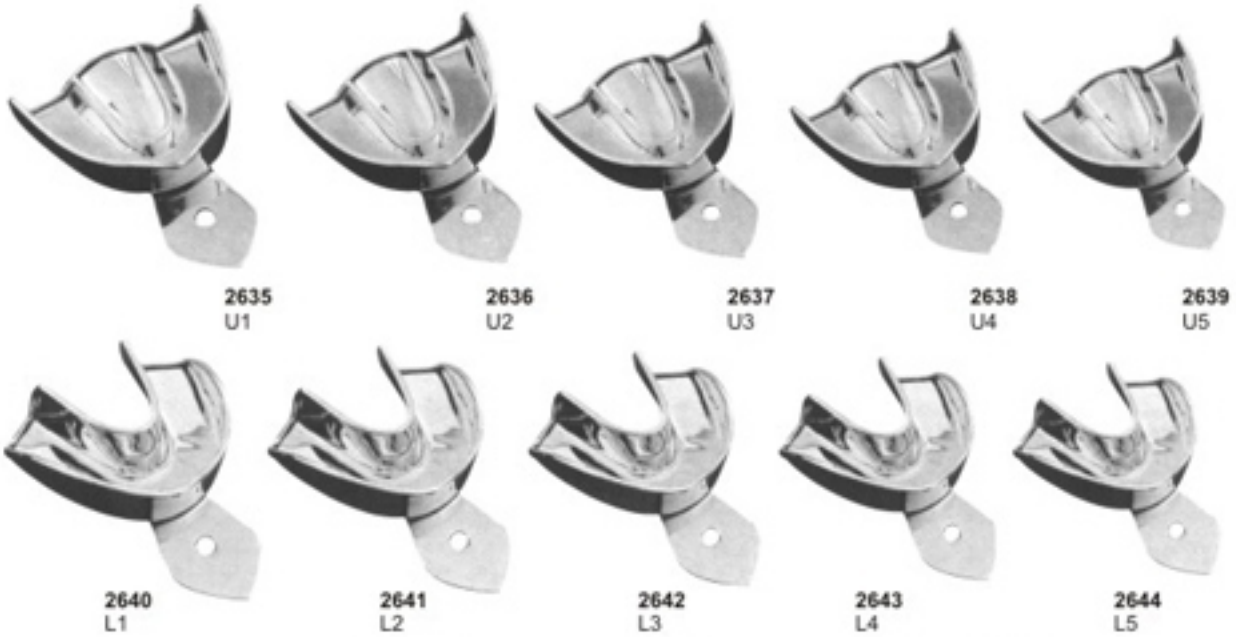

All The Above Impression Trays are Available in These 5 Sizes

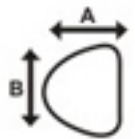

UPPER	U1	U2	U3	U4	U5
	A	62	60	53	54
B	83	75	73	69	68

All Dimension are in mm

LOWER	L1	L2	L3	L4	L5
	A	63	61	57	60
B	82	81	78	74	71

All Dimension are in mm



Perforated, Set of 10

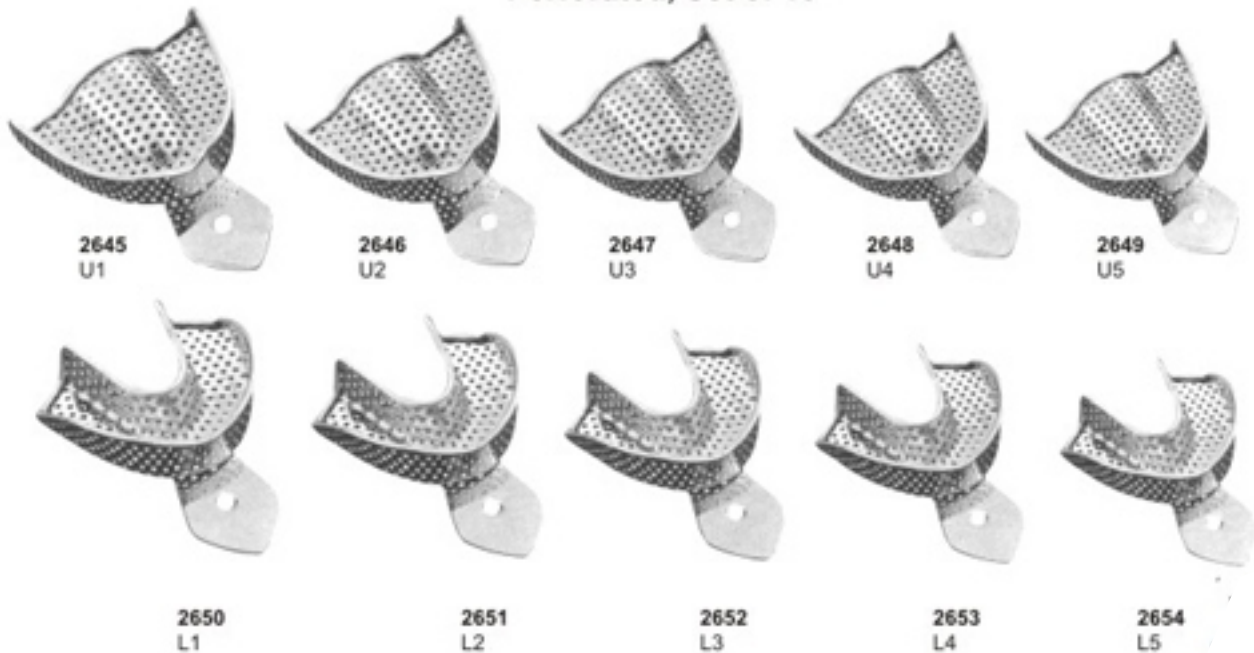

2645
U1

2646
U2

2647
U3

2648
U4

2649
U5

2650
L1

2651
L2

2652
L3

2653
L4

2654
L5

Impression Trays

Made of 18/8 Stainless Steel, Solid Full Denture Set of 8

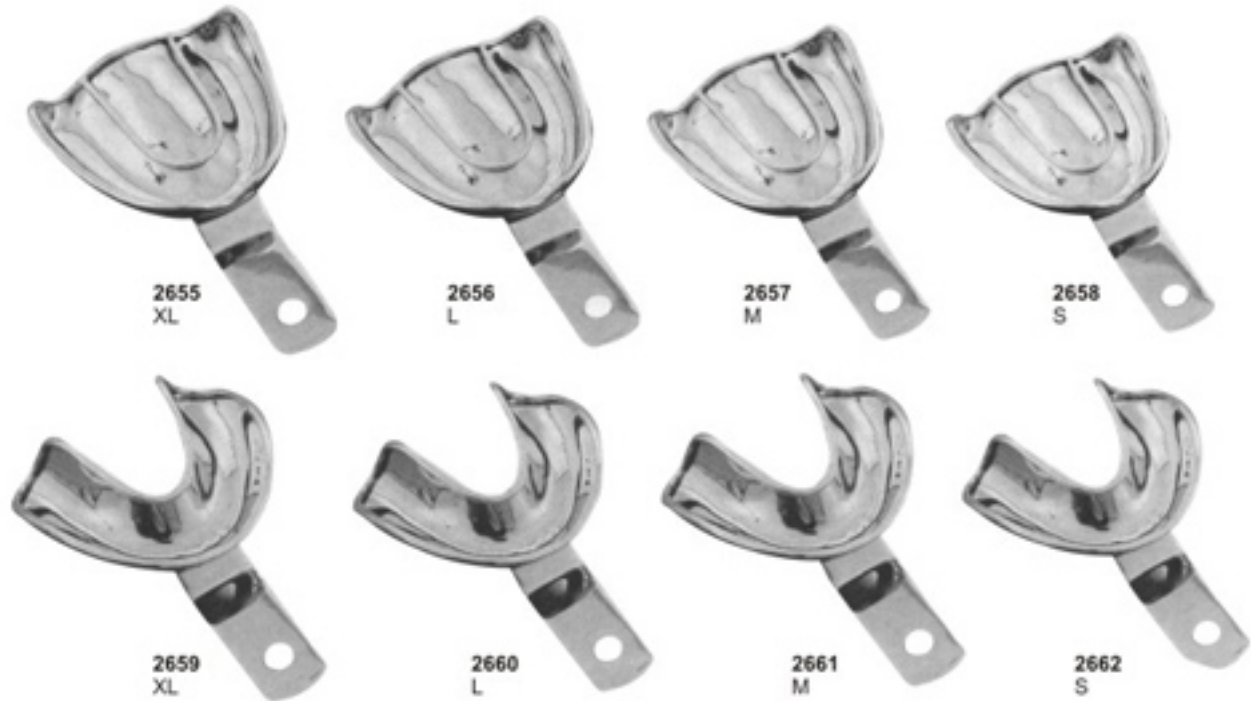

All The Above Impression Trays are Available in These 4 Sizes

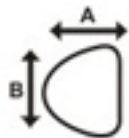

UPPER		XL	L	M	S
	A	70	67	64	60
B	79	76	70	73	

All Dimension are in mm



LOWER		XL	L	M	S
	A	64	64	60	57
B	86	70	73	70	

All Dimension are in mm

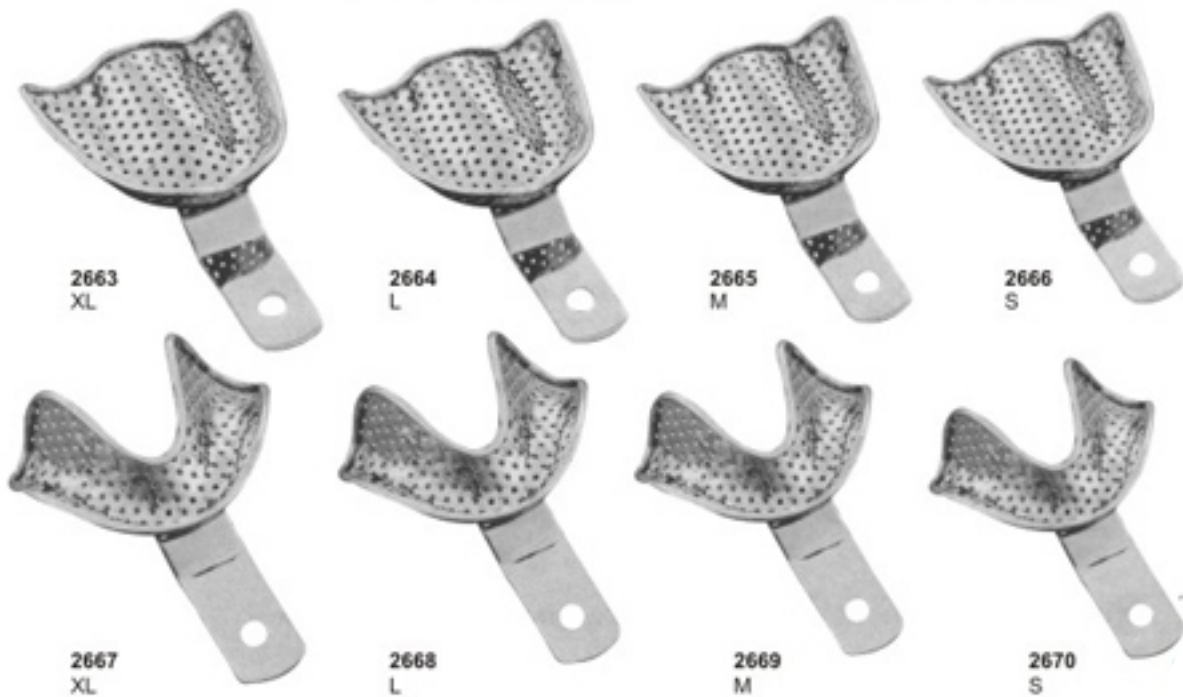

Perforated Full Denture Set of 8

Impression Trays

Made of 18/8 Stainless Steel, Solid Set of 6



2671
U1

2672
U2

2673
U3

2674
L1

2675
L2

2676
L3

All The Above Impression Trays are Available in These 4 Sizes

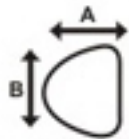

UPPER		U1	U2	U3
	A	67	64	57
B	81	71	70	

All Dimension are in mm



LOWER		L1	L2	L3
	A	60	57	54
B	81	79	76	

All Dimension are in mm

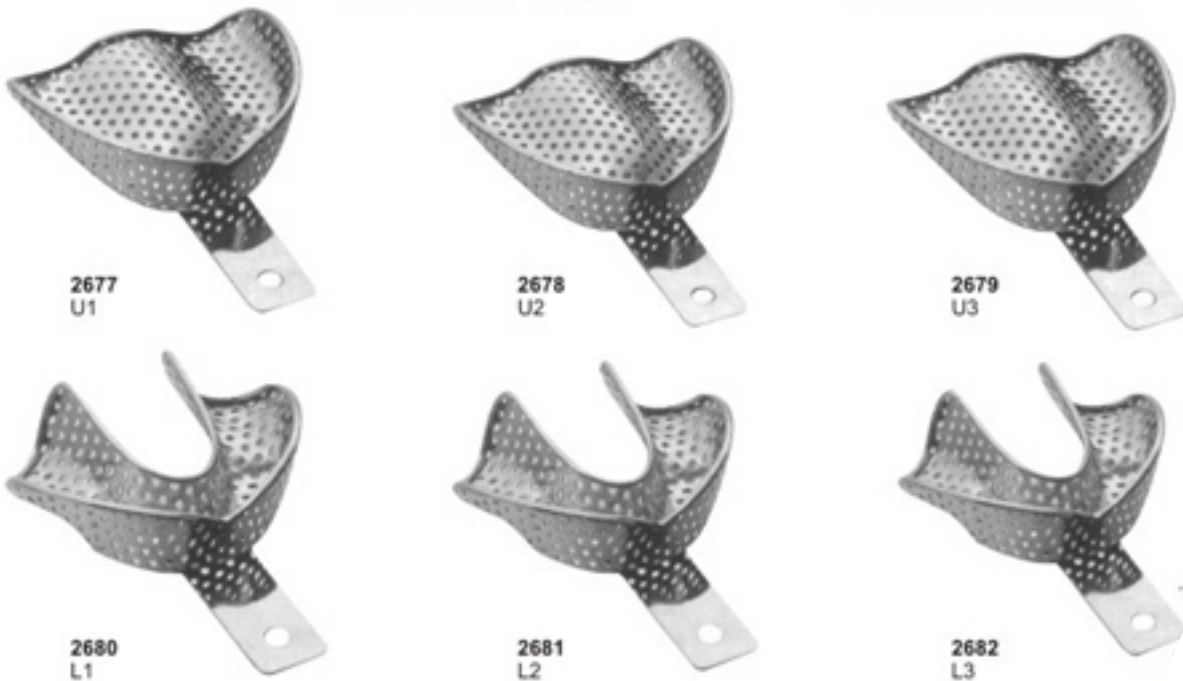

2677
U1

2678
U2

2679
U3

2680
L1

2681
L2

2682
L3

Perforated Set of 6

Made of 18/8 Stainless Steel, English Pattern Set of 8

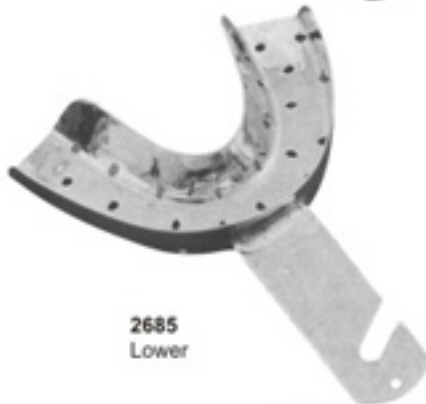

All The Above Impression Trays are Available in These 4 Sizes

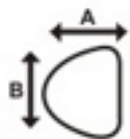

UPPER	Size	A	B	C
	0	67	50	12
	1	72	51	13
	2	78	55	15
	3	80	58	15

All Dimension are in mm

LOWER	Size	A	B	C
	0	70	50	14
	1	77	51	15
	2	79	55	15
	3	80	60	17

All Dimension are in mm



Impression Trays

Made of 18/8 Stainless Steel, Solid Full Denture Set of 8



All The Above Impression Trays are Available in These 4 Sizes

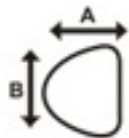

UPPER		XL	L	M	S
	A	70	67	64	60
B	79	76	70	73	

All Dimension are in mm

LOWER		XL	L	M	S
	A	64	64	60	57
B	86	70	73	70	

All Dimension are in mm

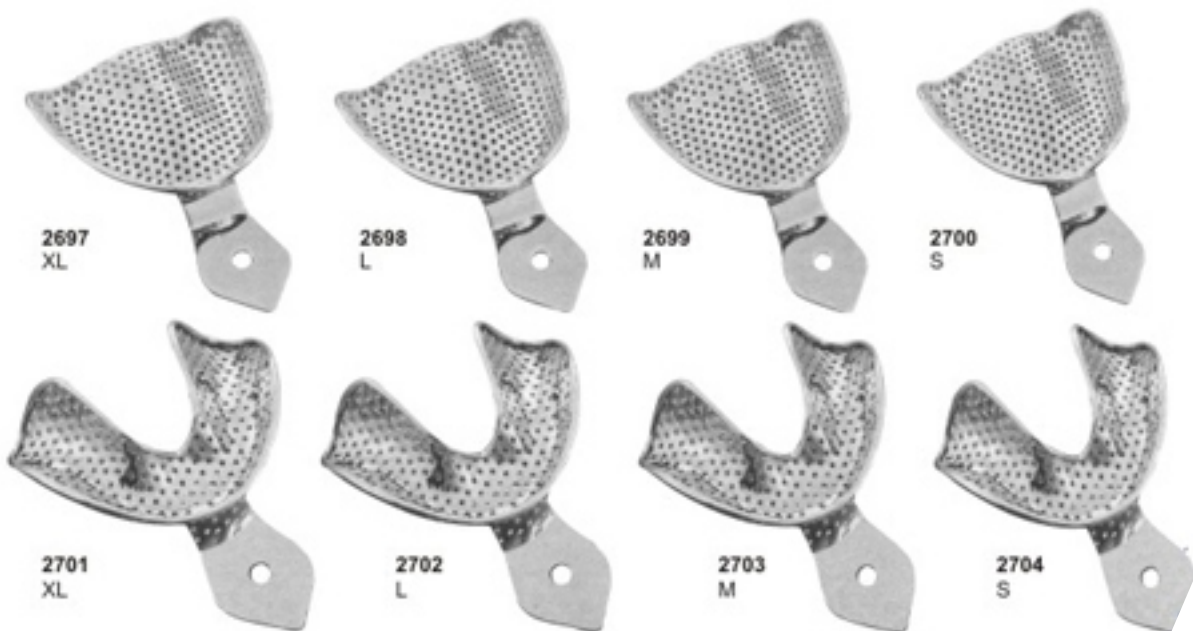

Made of 18/8 Stainless Steel, Perforated Full Denture Set of 8

Impression Trays

Made of 18/8 Stainless Steel, Solid Full Denture Set of 8

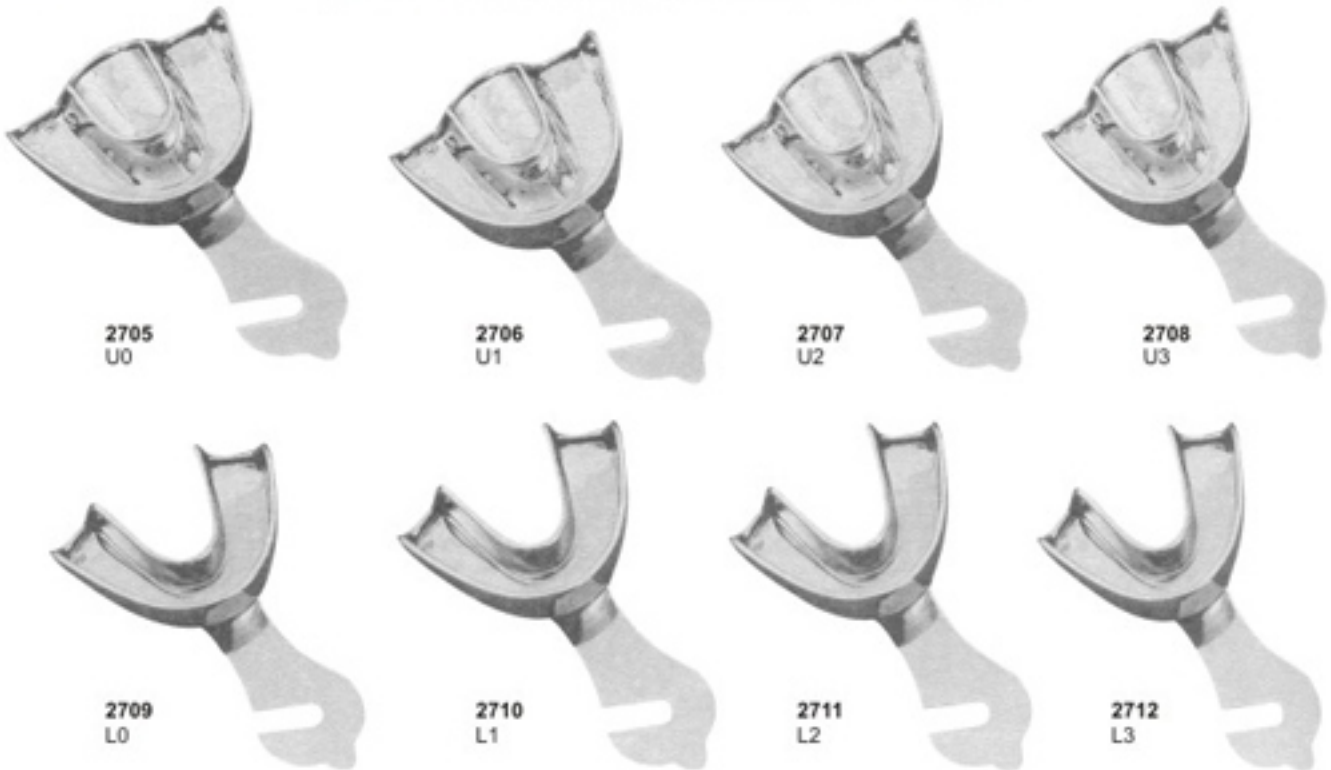

Upper Sizes: 0,1,2,3

Depth of Tray: 15,9 mm, Height of Plate: 12,5 mm

Lower Sizes: 0,1,2,3

Depth of Tray: 12,9 mm

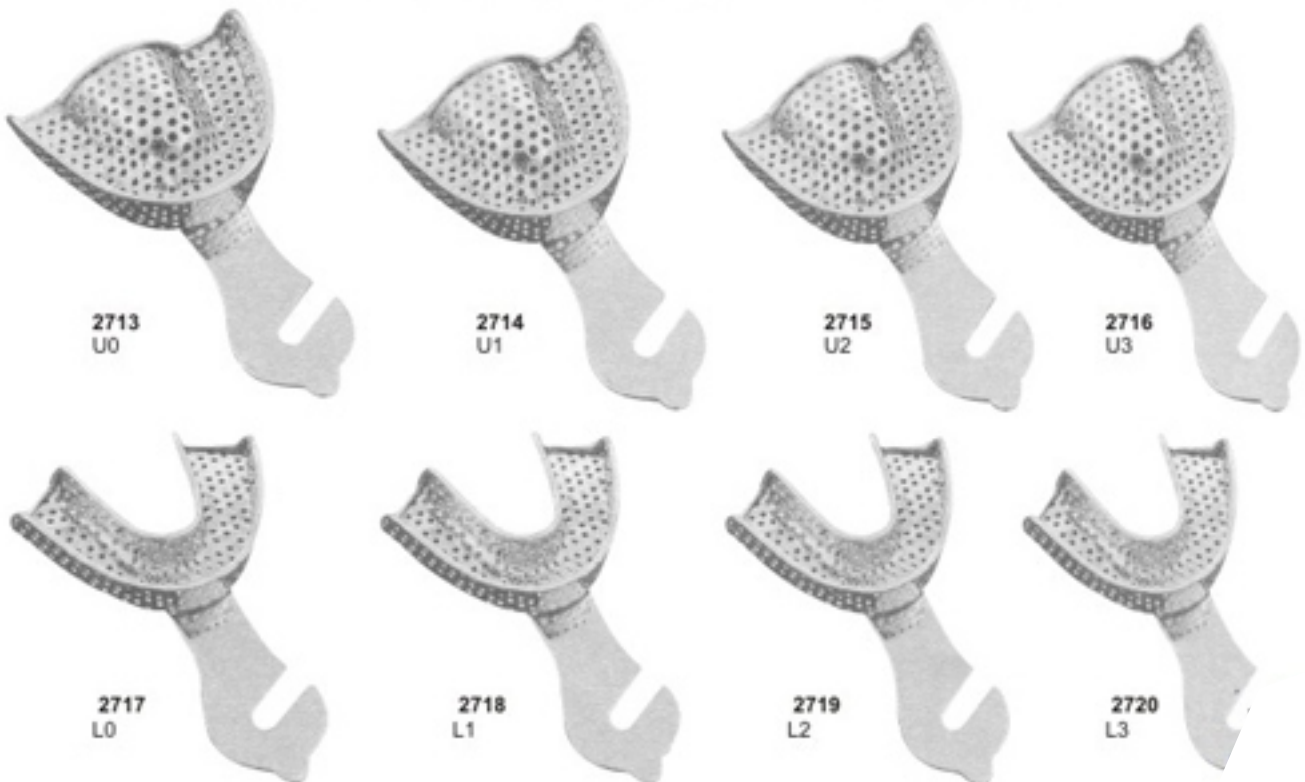

Made of 18/8 Stainless Steel, Perforated Full Denture Set of 8

Impression Trays For Crown & Bridge Work

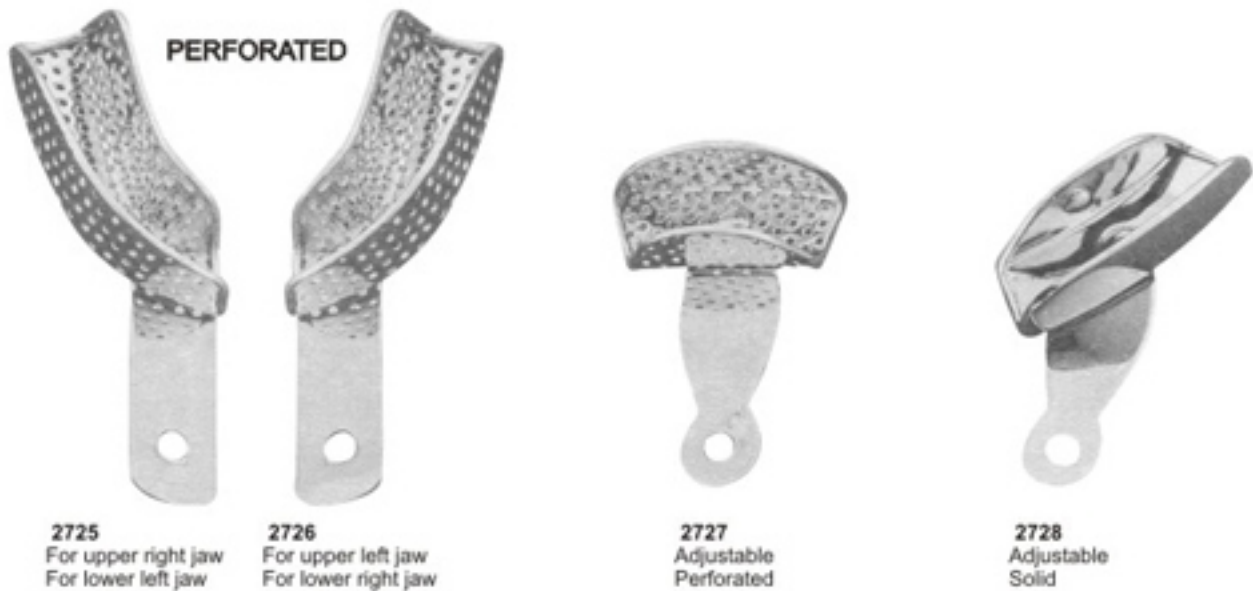
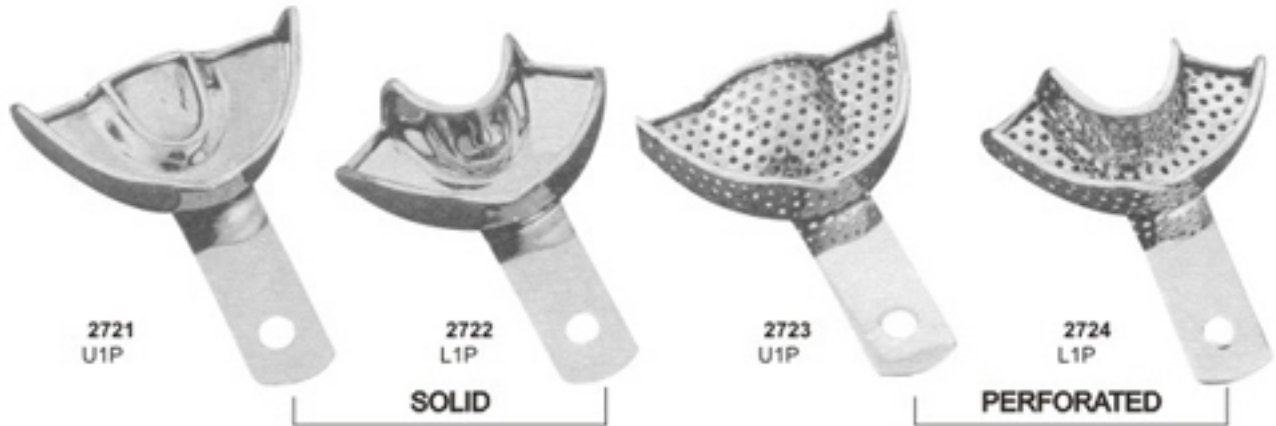

Available in 4 sizes

- 1.....44 mm
- 2.....55 mm
- 3.....60 mm
- 4.....65 mm



2729



2730



2731



2732



2734

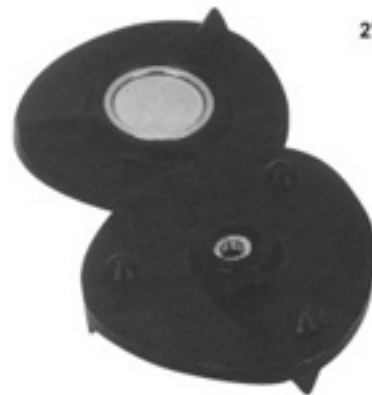

2733

Articulators

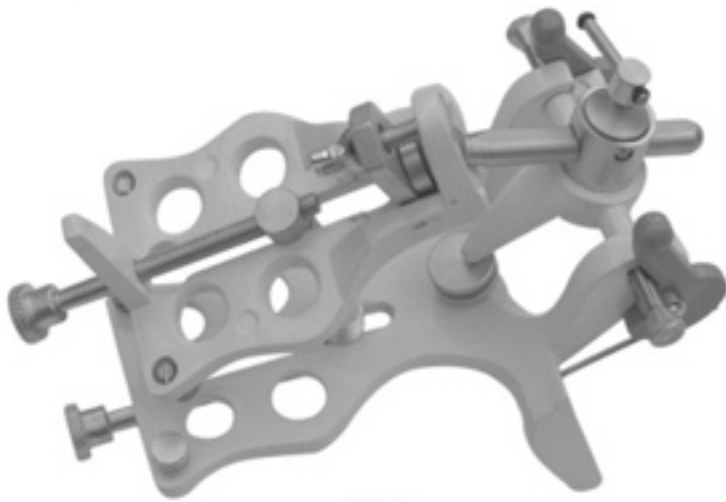

2735



2736



2737



2738



2739



2740



2741



2742



2743
Instruments Tray



2743
Instruments Tray



2744
Instruments Tray



2744
Instruments Tray

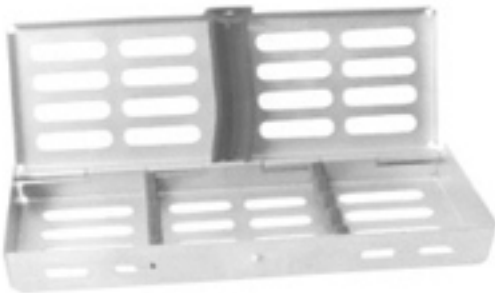

2745
Instruments Tray



2745
Instruments Tray



2746
Instruments Tray
Perforated



2747
Instruments Tray
Perforated Base



2748
Instruments Tray
Solid Base



2749
Pulpectomy Tray



2750
Sterilizing Box
Available Sizes:
17x17x3 cm
20x10x6 cm
30x14x6 cm



2751
Endo Tray Box



2752
Bucket With Handle & Lid
Stainlss Steel 18/10
Capacity:
6. Liter
10. Liter
12. Liter
15. Liter

2753
Sterilizing Drum
150x150mm
175x175mm
190x190mm
200x140mm
200x200mm
240x120mm
225x225mm
240x240mm
290x160mm



2754
Sterilizing Drum
280x240mm
230x150mm
300x250mm
340x160mm
350x250mm
390x200mm
380x300mm
100x100mm
150x120mm

Sterilizing Boxes & Instruments Trays



2755
Instruments Box



2756
Instruments Box



2757
Instruments Box



2758
Instruments Sterilizer
150x75 mm



2759
Endodontic Box



2760
Sterilizing Box
320x120 mm



2761
Instruments Tray



2762
Instruments Tray



2763
Instruments Tray
(Perforated)



2764
Instruments Tray
Shallow(Mayo)



2765
Scalers Tray



2766
Scalers Tray



2772
Spitten Mug



2773
Spirit Burner With Wick
Stainless Steel 18/10
Capacity: 150 ml, 60 ml



2774
Spirit Burners With Wick
Stainless Steel 18/10
Capacity: 70ml



2775
Dressing Jar



2776
Dressing Jar



2777
Irrigator(Douch Can)



2778
Measuring Ju



2779
Gallipot



2780
Medicine Cup



2781
Funnel 100 mm



2782
Tube Rack, Round Model
Stainless Steel 18/10



2783
Tube Rack, Stainless Steel 18/10



2784
Bed Pan (Perfection) Type Child
With & Without Cover 300 mm



2785
Bed Pan (Type French)
430 mm



2786
Urinals Female
(1 Piece)Capacity 0.75 Ltr



2787
Urinals Male
Capacity 1 Ltr



2788
Urinals Male
Capacity 0.75 Ltr



2789
Bed Pan Hand Made
Adult / Child



2790
Bed Pan (Type Sleeper)
With & Without Cover
Child 300 mm / Adult 350 mm



2791
Bed Pan (Type Round)
300 x 85 mm

Hollow Wares



2792
Sponge Bowl



2794
Wash Basin
300mm-350mm-400mm



2793
Sponge Bowl



2795
Kick Bucket With Trolley



2796
Kidney Tray Shallow
150mm-200mm-240mm-300mm



2797
Kidney Tray Without Lid
150mm-200mm-250mm-300mm



2798
Kidney Tray With Lid
150mm-200mm-250mm-300mm



2799
Dustbin Without Stand
6-10-12 Ltr



2800
Dustbin Without Stand & Cap
6-10-12 Ltr



2801
Needle Case Rectangle
Needle Case Round With Cover
90x15

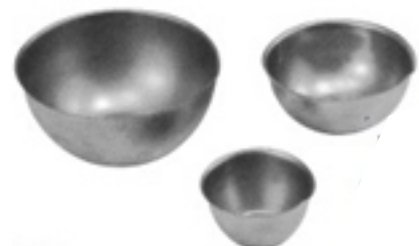

2802
Lotion Bowl With Lip
150mm-200mm-250mm-300mm

Scissors With Tungsten Carbide Inserts



2803
Standard



14,5cm
16,5cm
18,5cm



2804
Standard



14,5cm
16,5cm
18,5cm



2805
Standard



14,5cm
16,5cm
18,5cm



2806
Standard



14,5cm
16,5cm
18,5cm



2807
Standard



14,5cm
16,5cm
18,5cm



2808
Standard



14,5cm
16,5cm
18,5cm

Scissors With Tungsten Carbide Inserts

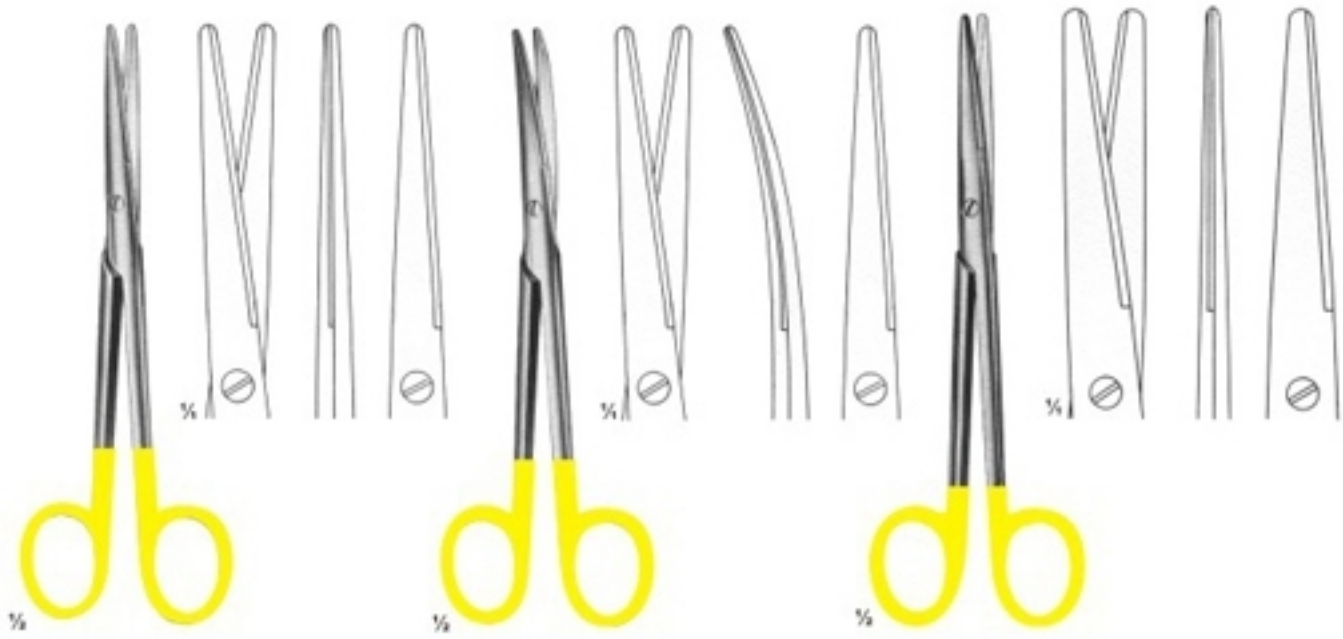

2809
MAYO-LEXER
Straight
16 cm

2810
MAYO-LEXER
Curved
16 cm

2811
LEXER
Straight
16, 21 cm

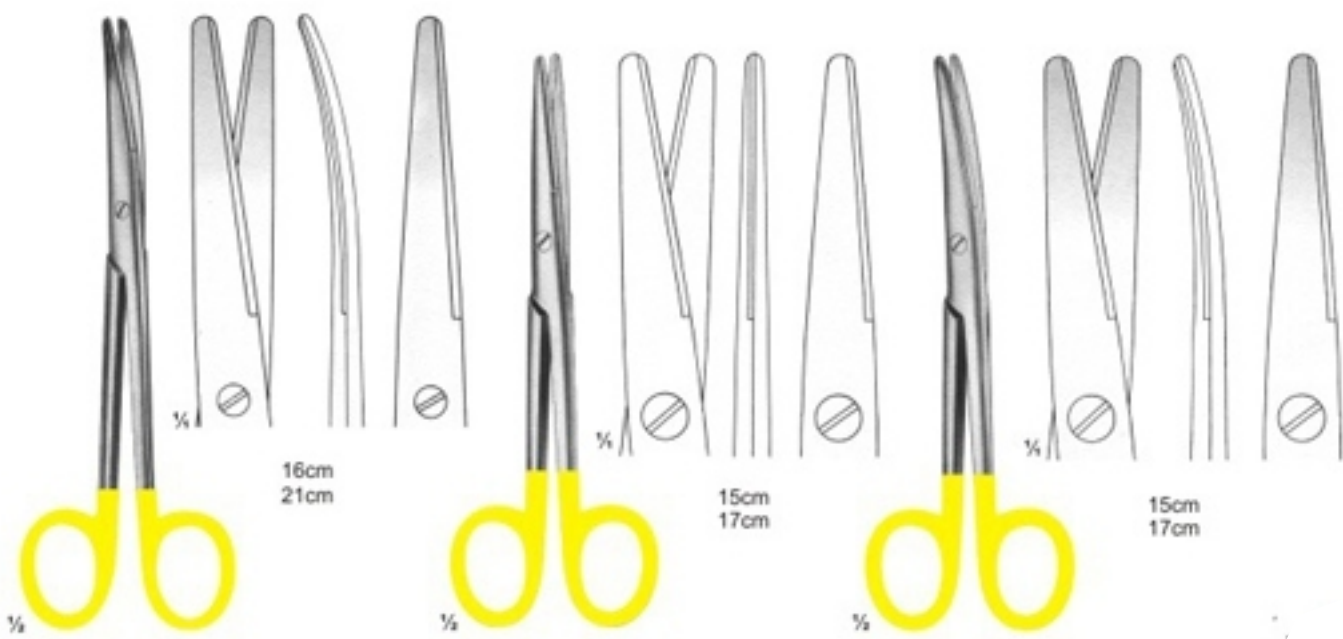

2812
LEXER
Curved
16, 21 cm

2813
MAYO-STILLE
Straight
15, 17 cm

2814
MAYO-STILLE
Curved
15, 17 cm

Scissors With Tungsten Carbide Inserts



18cm 11,5cm
20cm 14,5cm
28cm 23,5cm
30cm 25,5cm

2815
METZENBAUM
Straight



11,5cm 14,5cm
23cm 25cm

2816
METZENBAUM
Curved

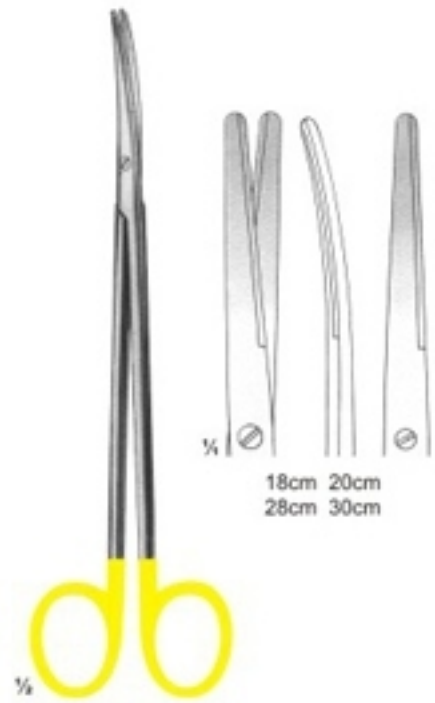

18cm 20cm
28cm 30cm

2817
METZENBAUM
Curved



14cm 18cm 20cm
23cm 25cm 28cm

2818
METZENBAUM FINO
Straight



14cm 18cm 20cm
23cm 25cm 28cm

2819
METZENBAUM FINO
Curved



14cm 18cm
20cm 23cm

2820
METZENBAUM FINO
Sharp



2821
BRUNS
235 mm

Scissors With Tungsten Carbide Inserts

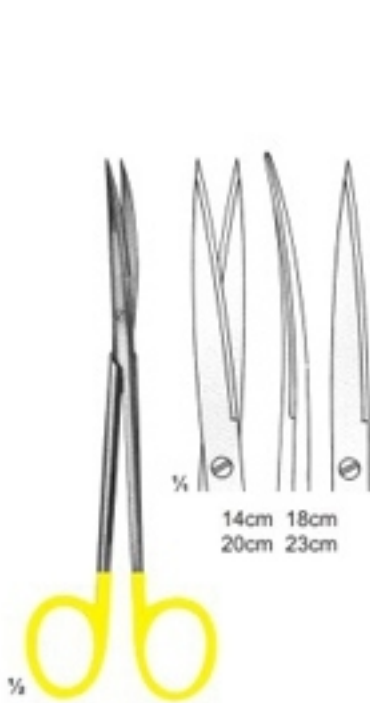

2822
METZENBAUM FINO



2823
METZENBAUM FINO

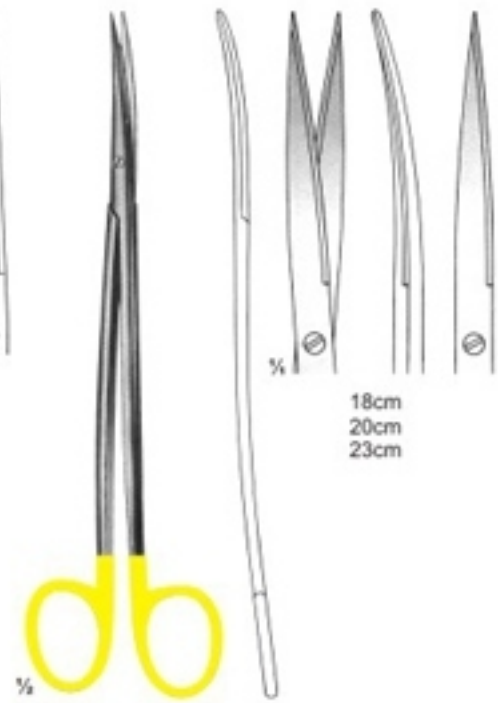

2824
METZENBAUM FINO



2825
METZENBAUM FINO



2826
MAYO
Straight

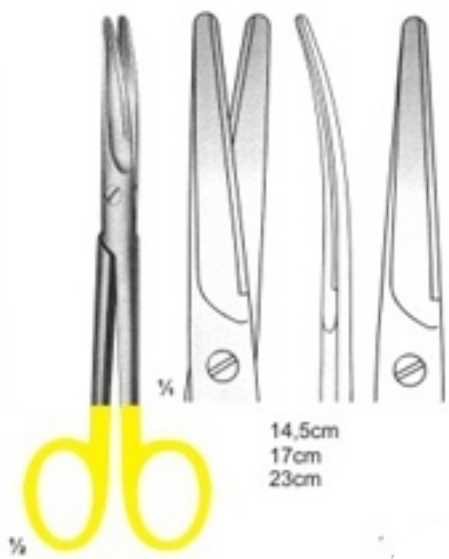

2827
MAYO
Curved

Scissors With Tungsten Carbide Inserts

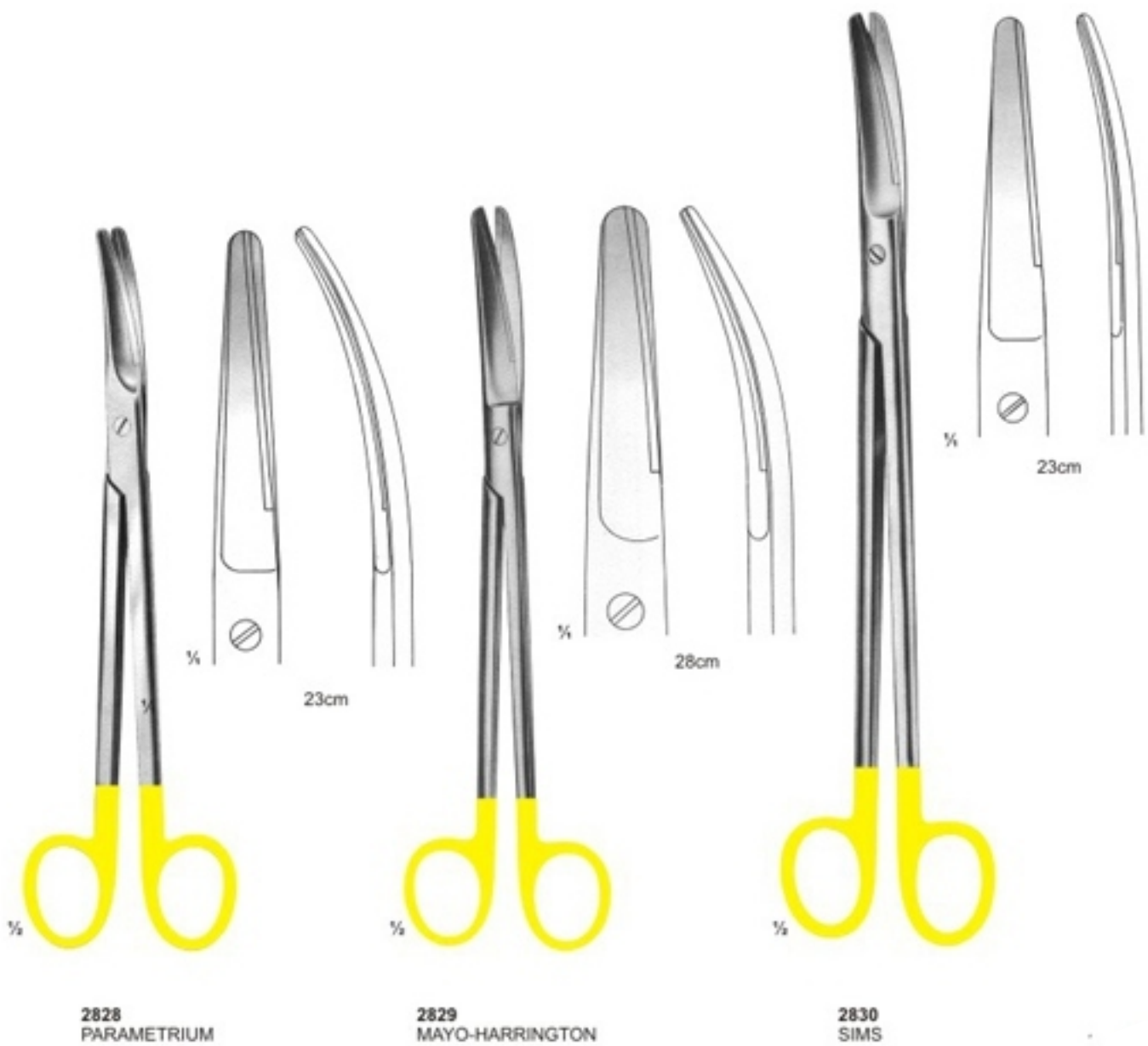

Scissors With Tungsten Carbide Inserts

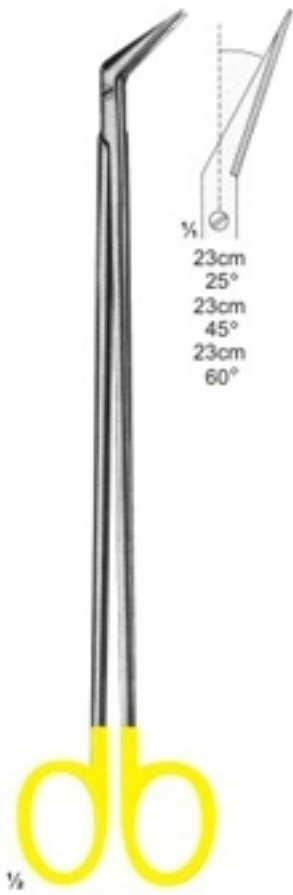

2831
DE-BAKEY



2832
DE-BAKEY

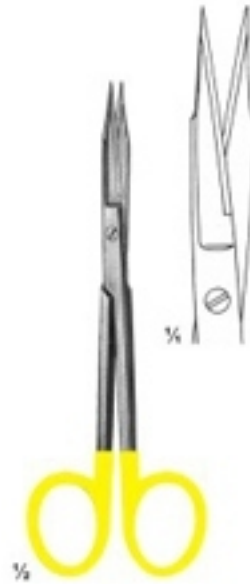

2833
GOLDMAN FOX
13 cm



2834
GOLDMAN FOX
13 cm



2835
Fine Scissors
Straight
11, 5 cm



2836
Fine Scissors
Curved
11, 5 cm



2837
Fine Scissors
Angled
11, 5 cm



2838
RAGNELL
Curved
12 cm

Scissors & Dissecting Forceps With Tungsten Carbide Inserts



2839
UNIVERSAL
12cm



2840
Ligature Scissors
1 Black & 1 Goldplated ring



2841
MERIAM
16 cm

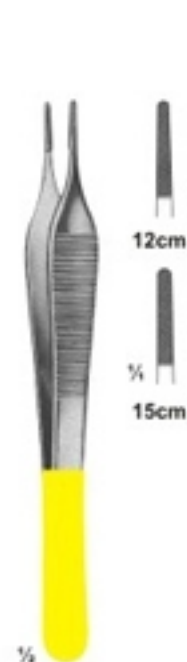

2842
ADSON



2843
CUSHING
17,5 cm

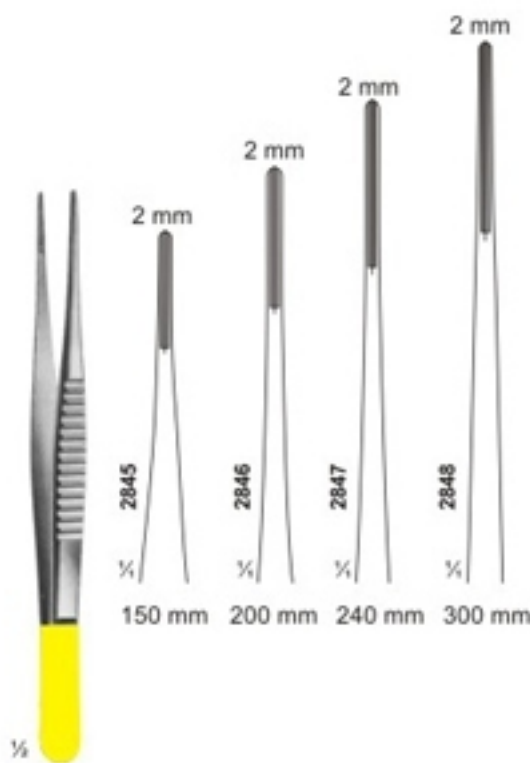

2844
DE BAKHEY
17,5 cm



2849
CUSHING
18 cm



2850
CUSHING-TAYLOR
18 cm



2851
Dressing Forceps
15 cm



2852
SEP
15

Dissecting Forceps & Needle Holders

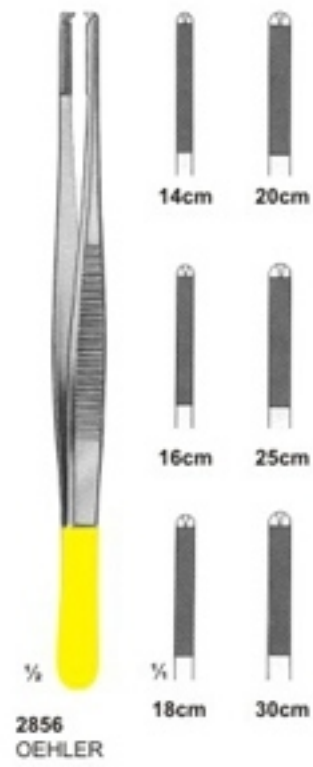
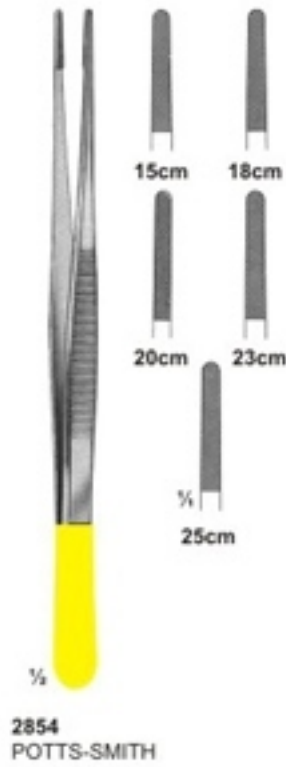

Needle Holders With T.C. Inserts

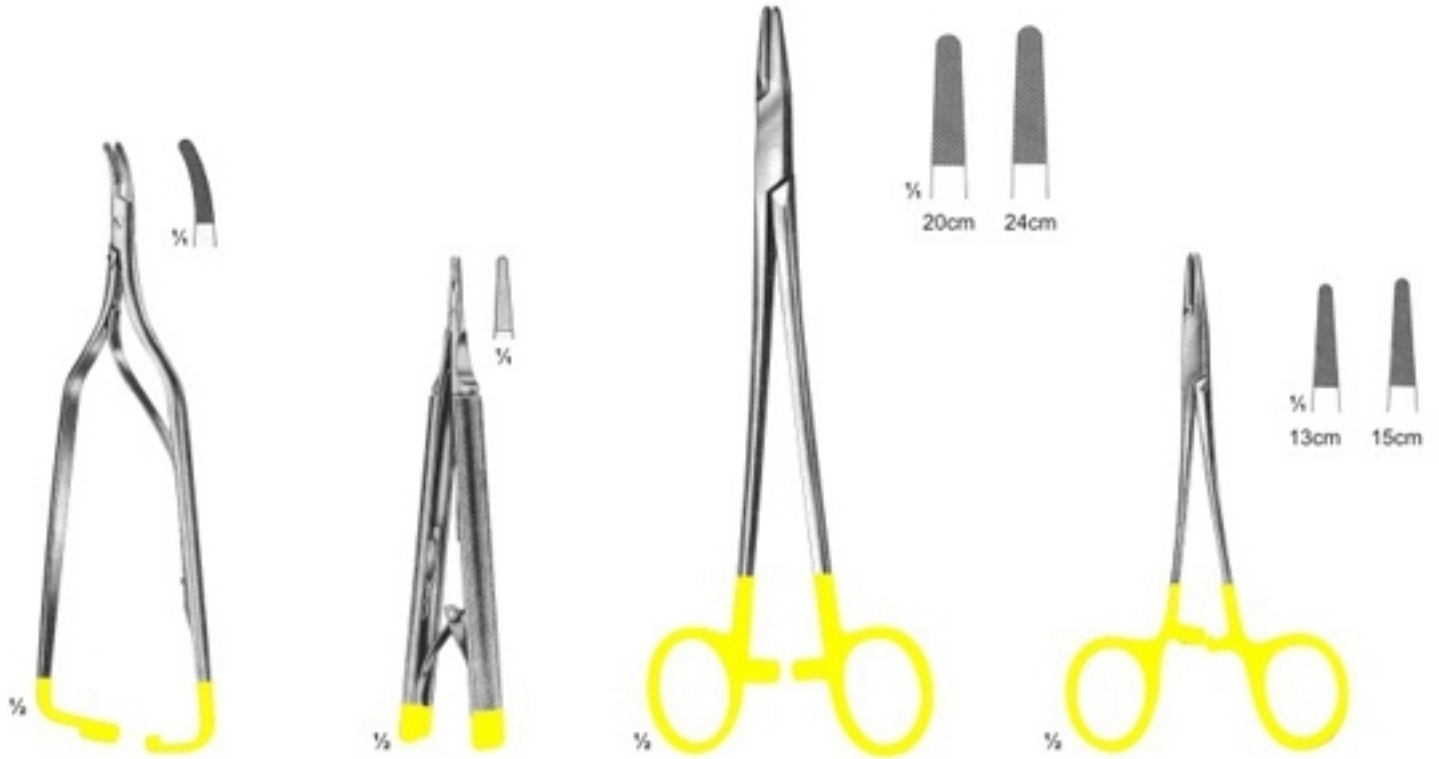

2863
ARRUGA
Curved
16 cm

2864
CASTROVIEJO
13 cm

2865
HEGAR
20,24 cm

2866
HALSEY
13,15 cm

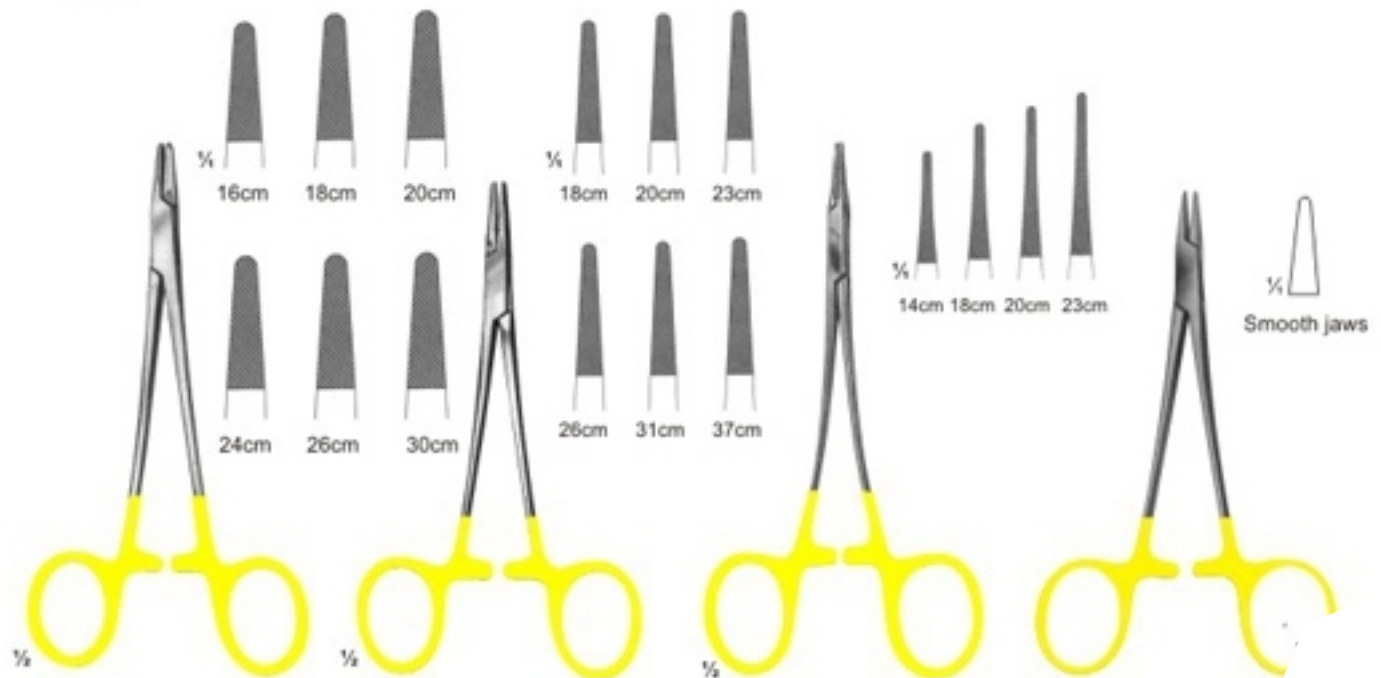

2867
MAYO-HEGAR

2868
DE BAKEY

2869
HEGAR-VASCULAR

2870
WEBSTER
125 mm

Needle Holders With Tungsten Carbide Inserts



2871
BOZEMANN-WERTHEIM
20, 24, 26 cm

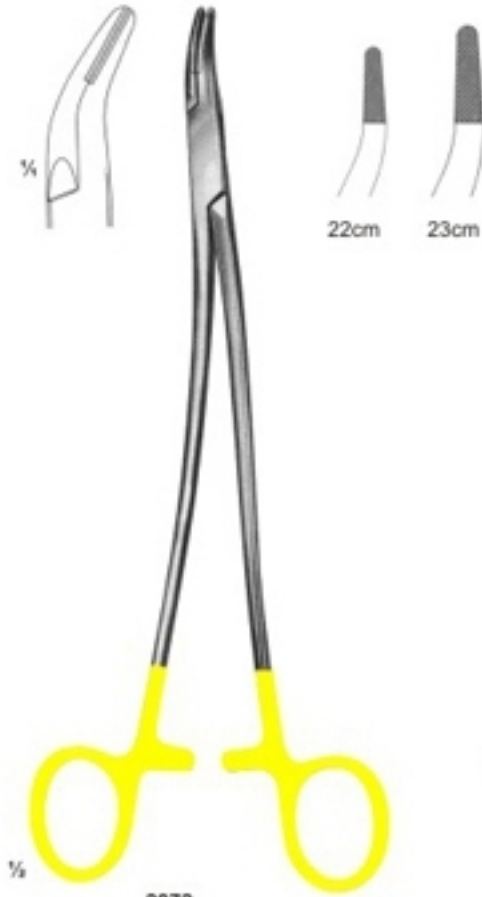

2872
STRATTE



2873
RYDER



2874
RYDER-VASCULAR

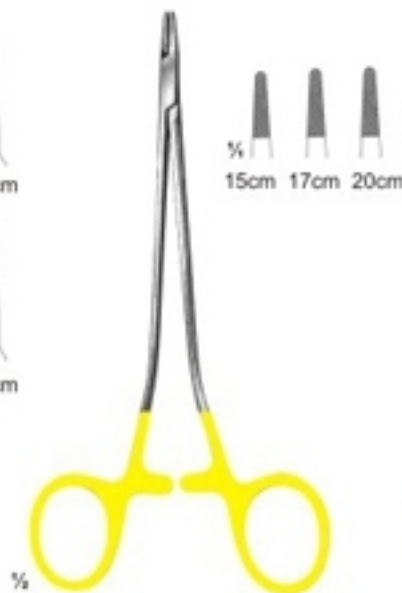

2875
MARTIN

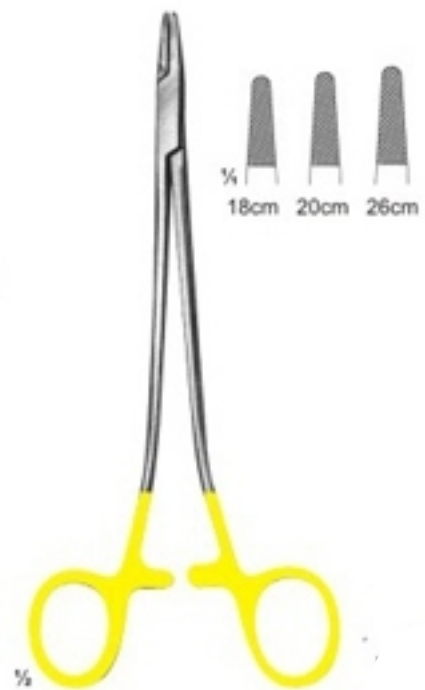

2876
SAROT

Needle Holders With Tungsten Carbide Inserts



2877
FINOCHIETTO
27 cm



2878
HEANEY
27,24 cm



2879
BAUMGARTNER
145 mm



2880
MATHIEU



2881
MATHIEU
14,17,20 cm



2882
MATHIEU-KOSHER
14,17,20,24 cm



2883
MATHIEU-KOSHER
17,20,24 cm



2884
MATHIEU-VASCUL
17,20,24 cm

Needle Holders With T.C. Inserts



2885
MATHIEU-RYDER
17,20,24 cm



2886
LICHTENBERG
20 cm



2887
LANGHALS
20,25 cm



2888
LICHTENBERG
20,25 cm



2889
LUEHTY-BECK
20,25 cm



2890
LUEHTY-BECK
20,25 cm



2891
LANGENBECK
18,20,23 cm

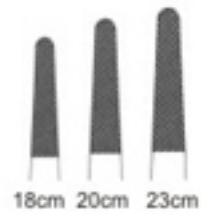

2892
LANGENBECK/
18,20,23 cm

Wire Cutting Plier With T.C. Inserts



2893
TOENNIS
Elastic pattern for
dura-or intestinal suture
180 mm



2894
Cutting Plier
12 cm

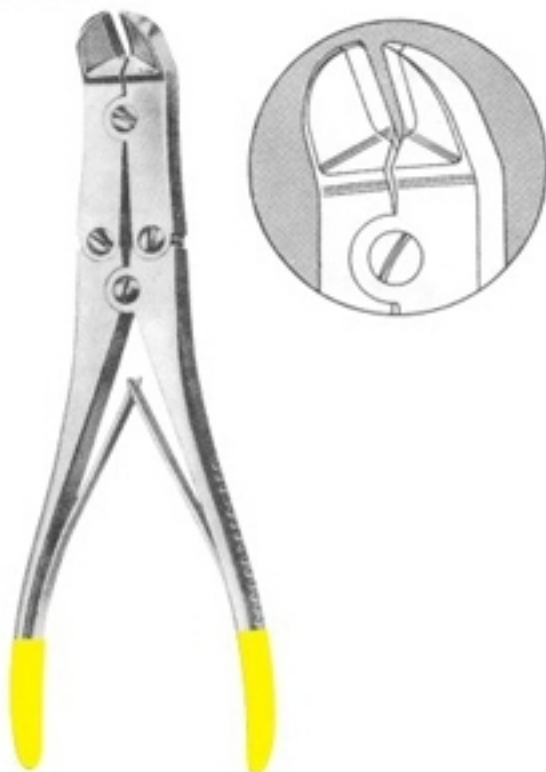

2895
MULLAR CLAUS
22 cm



2896
Plier
17.5 cm



Certified: ISO 9001:2008, CE



Belmera
ENTERPRISES

**Boukan Road, P/O Gohadpur
Sialkot 51310 - Pakistan.**

Tel : +92 - 52 - 4295904

Mob: +92 - 300 - 6125071

+92 - 333 - 8623076

Fax : +92 - 52 - 4290669

E-mail: belmeraent@gmail.com

info@belmeraent.com

Web: www.belmeraent.com

